

Toshiba Air Conditioning Data Sheet

RAS-18E2KVG-E
SEIYA (E2) INDOOR UNIT

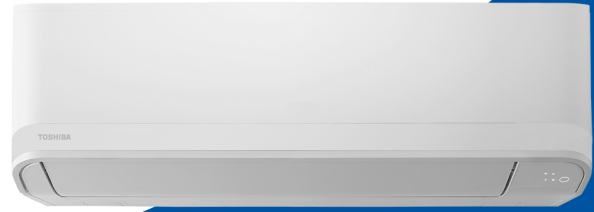

Model Reference		RAS-B18E2KVG-E	
Nominal	Cooling Capacity	kW	5.0
	Heating Capacity	kW	5.4
	EER/COP	W/W	3.33/3.60
UK	Cooling Total/Sensible	kW	4.88/3.57
	Heating	kW	3.34
Cooling EN14825	Range Min. - Max.	kW	1.45 - 5.50
	Power Input	kW	1.50
	Pdesign	kW	5.0
	SEER/Energy Efficiency Class		7.00/A++
	Seasonal Energy Consumption	kWh/a	250
Heating EN14825	Range Min. - Max.	kW	1.35 - 6.00
	Power Input	kW	1.50
	Pdesign	kW	3.8
	SCOP/Energy Efficiency Class		4.40/A+
	Seasonal Energy Consumption	kWh/a	1209
Air Flow	High - Low	l/s	233 - 133
	High - Low	m ³ /h	840 - 480
Sound	Pressure High - Low	dB(A)	48 - 26
	Power High	dB(A)	60
Unit	Height x Width x Depth	mm	293 x 798 x 230
	Weight	kg	9
Pipe Connection	Flare Connections (gas - liquid)	inch	1/2" - 1/4"
	Drain Pipe Connection OD/ID	mm	16/14
Remote controller			WH-TG01NE

TOSHIBA

- invisible piping cut-out
- ultra fresh filter
- new remote control
- wireless adapter is supported and can be installed inside the indoor unit
- supports energy monitoring; remote control is connectable with wires and dustless heat exchanger

(Unit : mm)

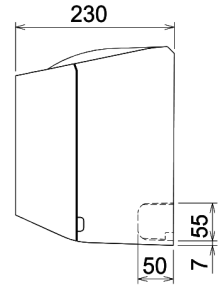
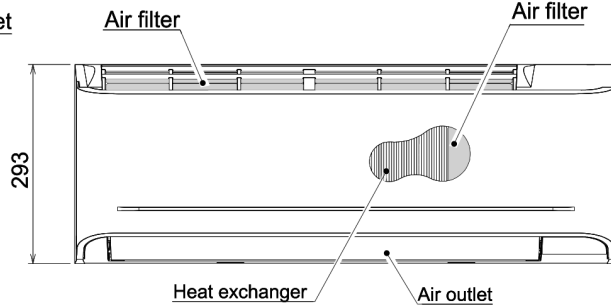
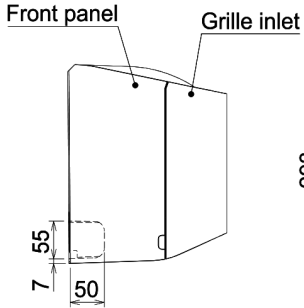
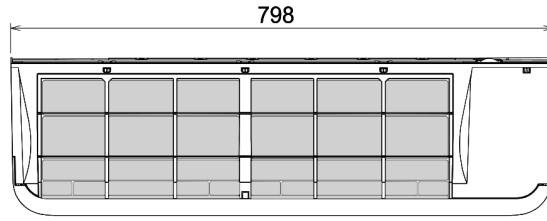

Knock out system

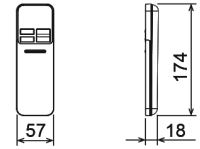
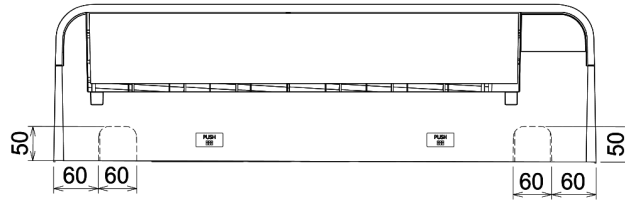

Wireless remote controller

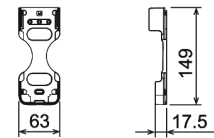

Remote controller holder

