

Toshiba Air Conditioning Data Sheet

RAS-B07E2KVG-E
SEIYA (E2) INDOOR UNIT

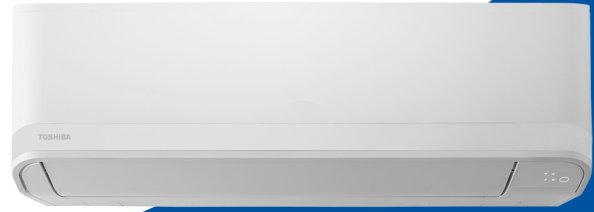

Model Reference		RAS-B07E2KVG-E	
Nominal	Cooling Capacity	kW	2.0
	Heating Capacity	kW	2.5
	EER/COP	W/W	3.77/3.91
UK	Cooling Total/Sensible	kW	1.95/1.57
	Heating	kW	1.60
Cooling EN14825	Range Min. - Max.	kW	0.76 - 2.60
	Power Input	kW	0.53
	Pdesign	kW	2.0
	SEER/Energy Efficiency Class		6.90/A++
	Seasonal Energy Consumption	kWh/a	101
Heating EN14825	Range Min. - Max.	kW	0.82 - 3.30
	Power Input	kW	0.64
	Pdesign	kW	2.0
	SCOP/Energy Efficiency Class		4.60/A++
	Seasonal Energy Consumption	kWh/a	609
Air Flow	High - Low	l/s	140 - 58
	High - Low	m ³ /h	500 - 209
Sound	Pressure High - Low	dB(A)	38 - 19
	Power High	dB(A)	51
Unit	Height x Width x Depth	mm	288 x 770 x 225
	Weight	kg	9
Pipe Connection	Flare Connections (gas - liquid)	inch	3/8" - 1/4"
	Drain Pipe Connection OD/ID	mm	16/14
Remote controller			WH-TG01NE

TOSHIBA

- invisible piping cut-out
- ultra fresh filter
- new remote control
- wireless adapter is supported and can be installed inside the indoor unit
- supports energy monitoring; remote control is connectable with wires and dustless heat exchanger

(Unit : mm)

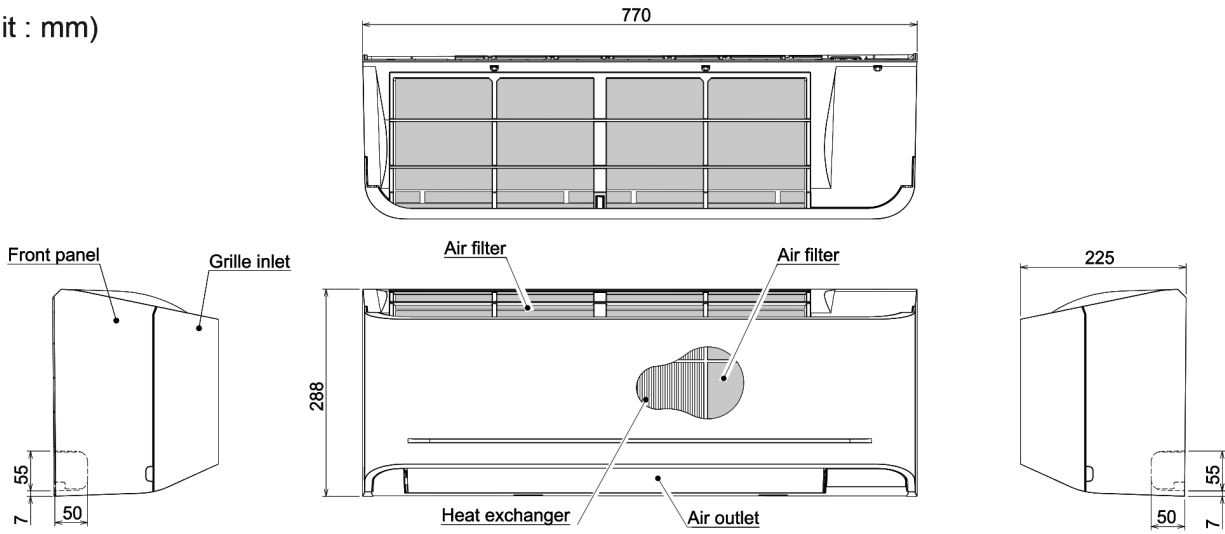

Knock out system

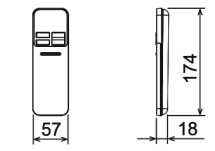
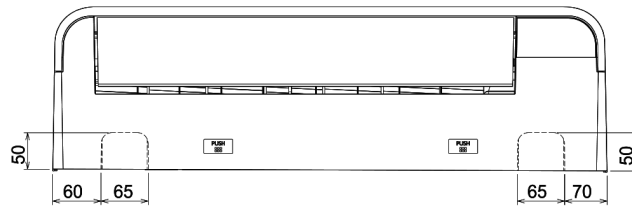

Wireless remote controller

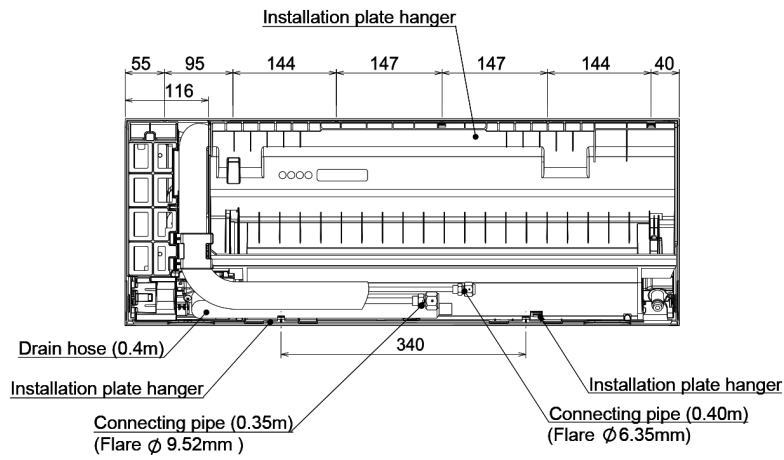

Remote controller holder

