

Toshiba Air Conditioning Data Sheet

MML-UP0121NHP-E
VRF BI FLOW



Model Reference		MML-UP0121NHP-E	
Capacity Code		HP	1.3
Nominal	Cooling Capacity	kW	3.6
	Heating Capacity	kW	4.0
UK	Cooling Total/Sensible	kW	3.3/2.4
	Heating	kW	2.7
Electrical	Power Input	kW	0.025
	Run Current	Amps	0.19
	Start Current	Amps	0.30
Air Flow	High - Medium - Low	l/s	153 - 113 - 90
	High - Medium - Low	m ³ /h	552 - 408 - 324
Sound	Pressure High - Medium - Low	dB(A)	40 - 34 - 29
	Power High - Medium - Low	dB(A)	55 - 49 - 44
Unit	Height x Width x Depth	mm	600 x 700 x 220
	Weight	kg	17
Pipe Connection	Flare Connections (gas - liquid)	inch	3/8 - 1/4
	Drain Pipe Connection OD/ID	mm	16/14
Power Supply	Suggested Fuse Size	V/ph/Hz-A	220-240/1/50-5
Remote Control			WH-L11SE (Infra-Red)

TOSHIBA

- Suitable for refurbishment projects
- Air distribution to suit the occupant's individual comfort requirements
- Wide choice of applications possible
- Compact space-saving unit design
- Rapid and flexible installation

MML-UP0071NHP* / MML-UP0091NHP* / MML-UP0121NHP* / MML-UP0151NHP* / MML-UP0181NHP*

unit:mm

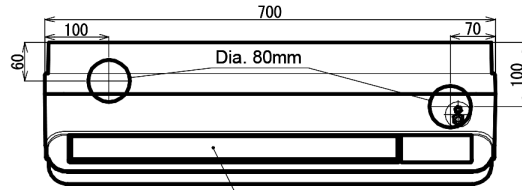

Connecting pipe

MML-	UP0071 to UP0121 type	UP0151 to UP0181 type
Liquid side	dia. 6.35	dia. 6.35
Gas side	dia. 9.52	dia. 12.7

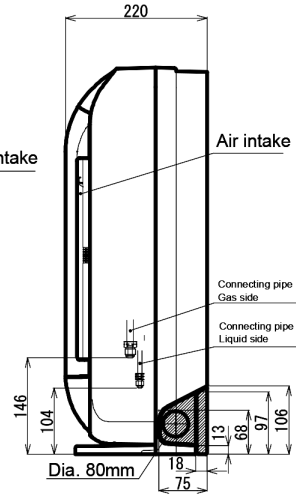
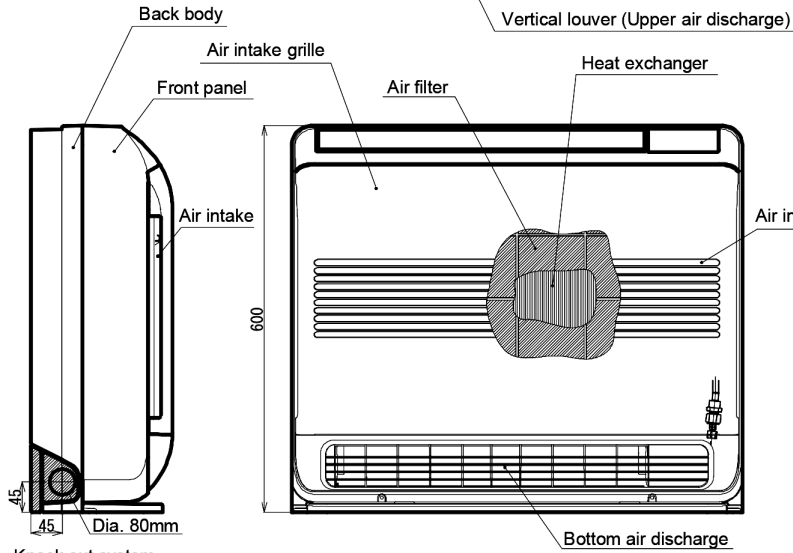

Knock out system

Knock out system

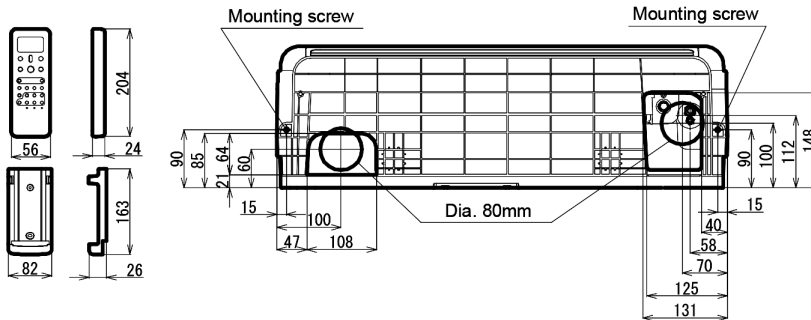

Space required for installation and servicing

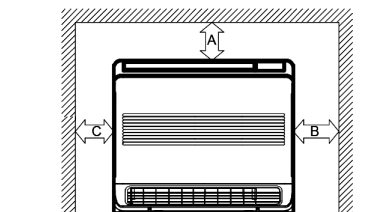

Distance
A 300 or more
B 300 or more
C 300 or more

