

Toshiba Air Conditioning Data Sheet

MMD-UP0481HP-E
VRF HIGH STATIC DUCTED



Model Reference	MMD-UP0481HP-E		
Capacity Code	Cooling Capacity	HP	5.0
Nominal	Heating Capacity	kW	14.0
	Cooling Total/Sensible	kW	16.0
UK	Heating	kW	12.7/9.3
	Power Input	kW	10.9
Electrical	Power Input	kW	0.300
	Run Current	Amps	1.81
	Start Current	Amps	2.41
Air Flow	High - Medium - Low	l/s	650 - 550 - 471
	High - Medium - Low	m ³ /h	2340 - 1980 - 1695
External Static Pressure	Standard	Pa	100
	Maximum	Pa	200
Sound	Pressure High - Medium - Low	dB(A)	44 - 41 - 38
	Power High - Medium - Low	dB(A)	59 - 56 - 53
Unit	Height x Width x Depth	mm	298 x 1400 x 750
	Weight	kg	43
Pipe Connection	Flare Connections (gas - liquid)	inch	5/8 - 3/8
	Drain Pipe Connection OD/ID	mm	32/25
Power Supply	Suggested Fuse Size	V/ph/Hz-A	220-240/1/50-10

TOSHIBA

- Ultra-flexible, invisible and silent unit
- Diffuser design flexibility
- Unobtrusive, flexible and compact
- Static pressure can be set to 7 levels from 50 to 250Pa
- Long-life filter and air discharge spigot available
- Built-in high-lift drain pump (sizes 18 to 56)

External dimensions

(Unit: mm)

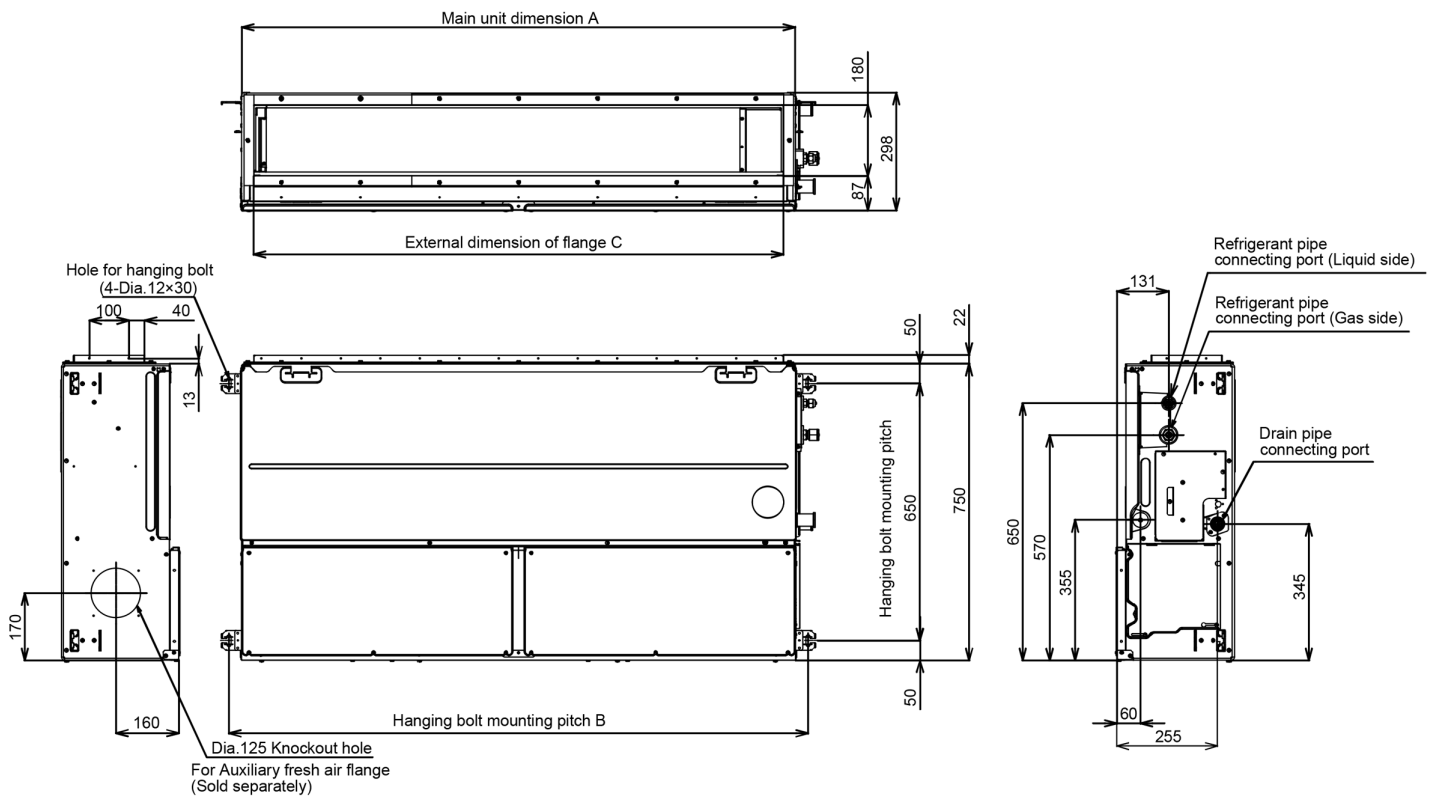

▼ Dimension

Model MMD-	A	B	C
UP018~UP027	1000	1065	940
UP036~UP056	1400	1465	1340