

Toshiba Air Conditioning Data Sheet

MMD-UP0241HP-E
VRF HIGH STATIC DUCTED



Model Reference	MMD-UP0241HP-E		
Capacity Code	Cooling Capacity	HP	2.5
Nominal	Heating Capacity	kW	7.1
	Cooling Total/Sensible	kW	8.0
UK	Heating	kW	6.4/4.9
	Power Input	kW	5.4
Electrical	Power Input	kW	0.140
	Run Current	Amps	0.92
	Start Current	Amps	1.22
Air Flow	High - Medium - Low	l/s	333 - 292 - 267
	High - Medium - Low	m ³ /h	1200 - 1050 - 960
External Static Pressure	Standard	Pa	100
	Maximum	Pa	200
Sound	Pressure High - Medium - Low	dB(A)	38 - 34 - 31
	Power High - Medium - Low	dB(A)	53 - 49 - 46
Unit	Height x Width x Depth	mm	298 x 1000 x 750
	Weight	kg	34
Pipe Connection	Flare Connections (gas - liquid)	inch	5/8 - 3/8
	Drain Pipe Connection OD/ID	mm	32/25
Power Supply	Suggested Fuse Size	V/ph/Hz-A	220-240/1/50-10

TOSHIBA

- Ultra-flexible, invisible and silent unit
- Diffuser design flexibility
- Unobtrusive, flexible and compact
- Static pressure can be set to 7 levels from 50 to 250Pa
- Long-life filter and air discharge spigot available
- Built-in high-lift drain pump (sizes 18 to 56)

External dimensions

(Unit: mm)

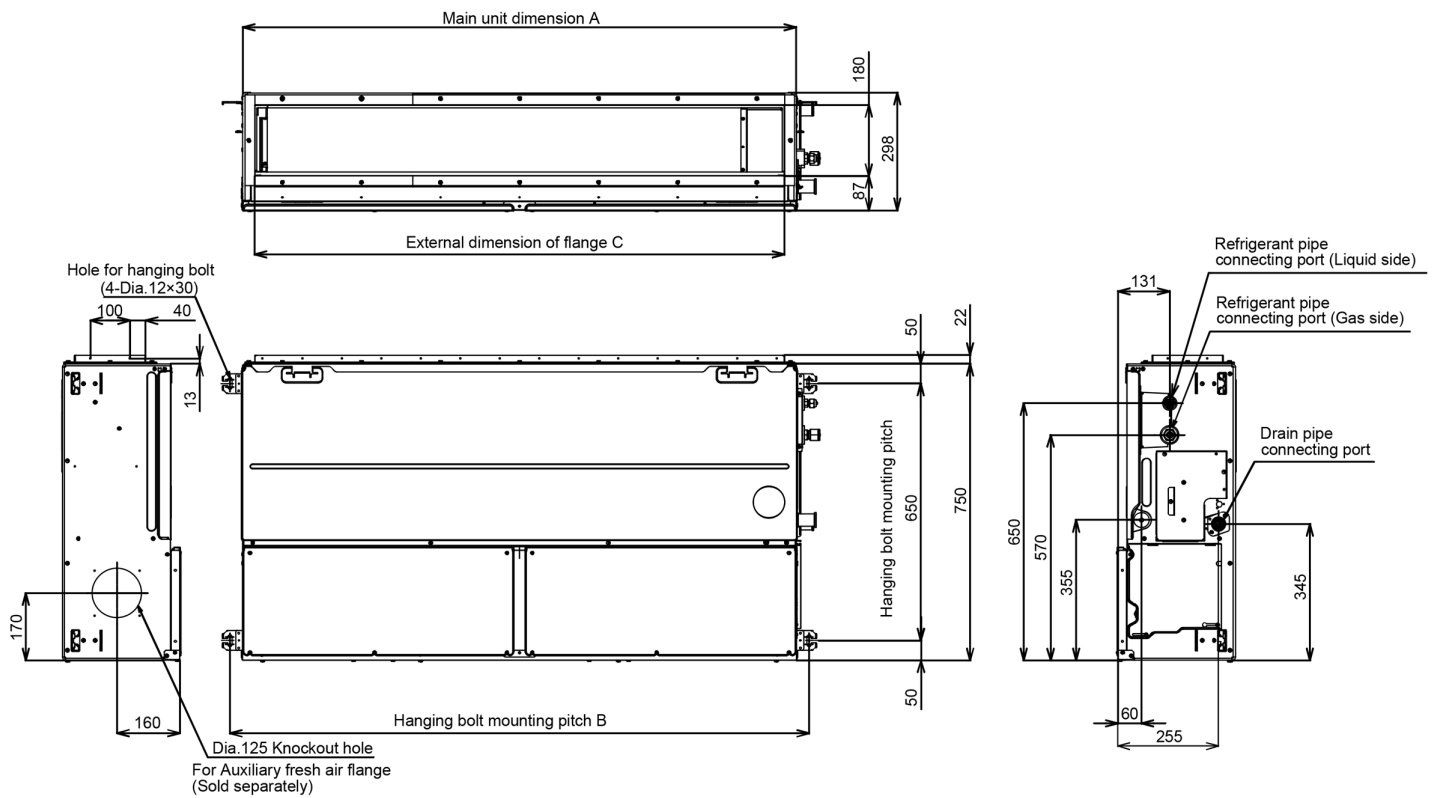

▼ Dimension

Model MMD-	A	B	C
UP018~UP027	1000	1065	940
UP036~UP056	1400	1465	1340