

Toshiba Air Conditioning - VRF Data Sheet

MMY-MAP1406FT8P

Three-pipe SHRMe - Super Heat Recovery Condensing Unit



Features

- Dual setpoint for more precision
- ESEER increased to >8
- UK-SEER achievable to >10
- New 4 series flow box with 50 m run
- New 4- and 6-port multi-flow boxes

Technical Data

Model reference		MMY-MAP1406FT8P
Nominal cooling	kW	40.0
Nominal heating	kW	45.0
Capacity code		14
Min./max. capacities connectable	kW	32.0/54.0
Power input (cool/heat)	kW	12.7/10.5
SEER/ESEER Value (Office Profile)		6.88/7.34
SCOP/ESCOP Value (Office Profile)		4.82/5.02
Starting current	A	1
Running current (cool/heat)	A	19.92/16.47
MCA (minimum circuit amps)	A	35.8
MOCP (maximum overcurrent protection)	A	50.0
Power supply	V-ph-Hz	380/415-3-50
Interconnecting cable		2-core screened 1.5 mm
Sound power (cool/heat)	dB(A)	81/83
Sound pressure (cool/heat)	dB(A)	62/64
Standard air flow	m ³ /h	12200
Standard air flow	l/s	3389
External static pressure	Pa	40
Maximum indoor units connectable		31
Dimensions (H x W x D)	mm	1830 x 1210 x 780
Unit weight	kg	316
R410A refrigerant base charge	kg	11

Note: The electrical installation needs to meet current electrical regulations BS7671:2018 the 18th Edition of the IET regulations.

Dimensional Drawings

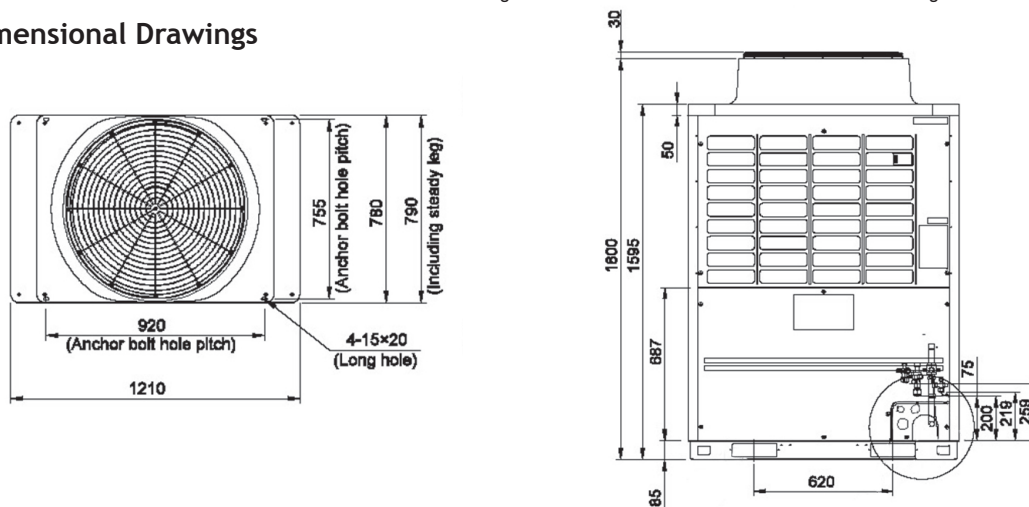

Cool Designs Ltd

Raising the Standards in Air Conditioning Distribution

www.cdlweb.info

