

Toshiba Air Conditioning - Estia Split Data Sheet

HWS-1405XWHT9-E Estia Split - Air-to-Water Heat Pump



Features

- High energy efficiency providing enhanced energy savings
- Quick and easy to install
- Large screen remote controller - simple, intuitive and easy to use
- Best in class performances

Hydro Unit Performance Data

Hydro unit combination	HWS-1405XWHT9-E	
Outdoor unit	HWS-1605H8(R)-E	
Seasonal space heating energy efficiency low temperature		
Energy efficiency class - low temperature	A++	
Seasonal space heating energy efficiency (η_s)	%	159
SCOP	4.05	
Under floor heating - air 7°C, water 35°C		
Maximum heating capacity	kW	16.76
Nominal heating capacity	kW	16.00
COP	W/W	4.30
Under floor heating - air -7°C, water 35°C		
Maximum heating capacity	kW	11.25
Heating capacity*	kW	9.05
COP	W/W	2.67
Under floor heating - air -15°C, water 35°C		
Maximum heating capacity	kW	8.63
Heating capacity*	kW	7.65
COP	W/W	2.52
Radiators heating - air 7°C, water 45°C		
Maximum heating capacity	kW	15.77
Radiators heating - air -7°C, water 45°C		
Maximum heating capacity	kW	10.64
Radiators heating - air -15°C, water 45°C		
Maximum heating capacity	kW	8.15
Seasonal space heating energy efficiency mid temperature		
Energy efficiency class - medium temperature	A++	
Seasonal space heating energy efficiency (η_s)	%	130
SCOP	3.33	
Radiators heating - air 7°C, water 55°C		
Maximum heating capacity	kW	14.12
Radiators heating - air -7°C, water 55°C		
Maximum heating capacity	kW	10.22
Nominal cooling capacity -air 35°C, water 7°C	kW	13.00
EER	W/W	2.71

Hydro Unit Physical Data

Hydro unit	HWS-1405XWHT9-E	
To be used with size	110-140-160	
Electric back-up heater capacity	kW	6.0
Leaving water temperature space heating	°C	20-55
Leaving water temperature space cooling	°C	7-25
Dimensions (H x W x D)	mm	925 x 525 x 355
Weight	kg	52
Sound pressure level	dB(A)	29
Electric back-up heater supply	V-ph-Hz	380/400-3-50
Maximum current	A	13.0 x 3

Maximum heating capacities are shown at peak value during operation, at maximum compressor operating range in accordance with EN14511. Nominal heating capacities are given at water delta T 5 K and rated compressor operating frequency in accordance with EN14511.
* Heating capacities at -7°C are shown at maximum compressor operating frequency in accordance with EN14511.
Energy efficiency class and Seasonal space heating energy efficiency (η_s) are provided for average climate conditions in accordance with EN14825.

Dimensional Drawings

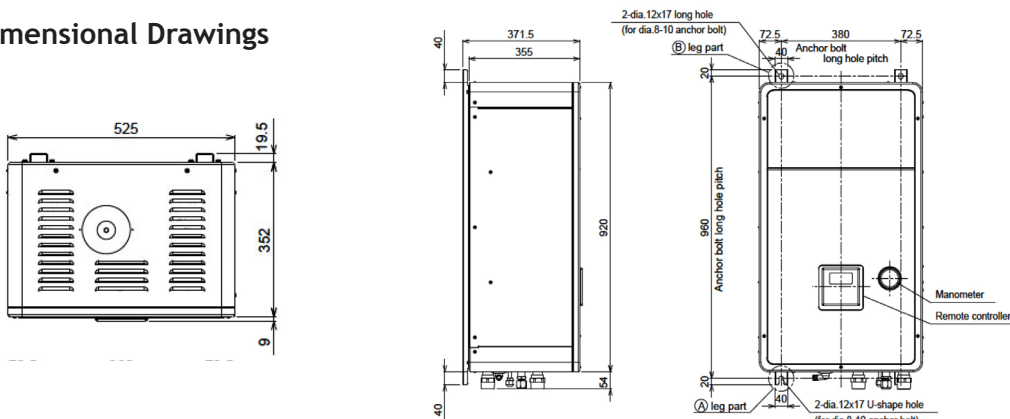

Cool Designs Ltd

Raising the Standards in Air Conditioning Distribution

www.cdlweb.info

