

TOSHIBA

R32 or R410A

AIR CONDITIONER (SPLIT TYPE) Installation Manual

Indoor Unit

Model name:

Concealed Duct High Static Pressure Type

RAV-RM2241DTP-E

RAV-RM2801DTP-E

For commercial use

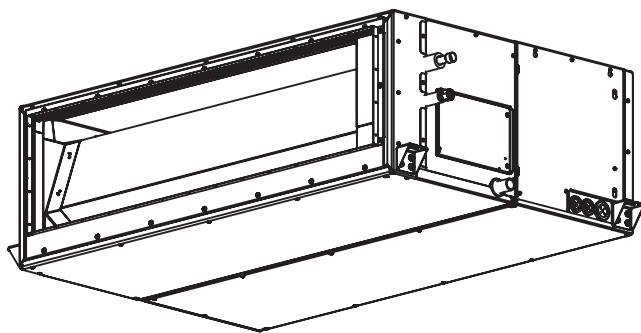

Original instruction

Please read this Installation Manual carefully before installing the Air Conditioner.

- This Manual describes the installation method of the indoor unit.
- For installation of the outdoor unit, follow the Installation Manual attached to the outdoor unit.
- For precaution for safety, follow the Installation Manual attached to the outdoor unit.

ADOPTION OF R32 or R410A REFRIGERANT

This Air Conditioner has adopted a refrigerant HFC (R32 or R410A) which does not destroy the ozone layer. Be sure to check the refrigerant type for outdoor unit to be combined, and then install it.

Product information of ecodesign requirements. (Regulation (EU) 2016/2281)
<http://ecodesign.toshiba-airconditioning.eu/en>

Contents

1	Precautions for safety	3
2	Accessory parts	8
3	Selection of installation place	8
4	Installation	10
5	Drain piping	11
6	Duct design	14
7	Refrigerant piping	15
8	Electrical connection	17
9	Applicable controls	19
10	Test run	24
11	Maintenance	24
12	Troubleshooting	25
13	Appendix	28

Thank you for purchasing this Toshiba air conditioner.

Please read carefully through these instructions that contain important information which complies with the Machinery Directive (Directive 2006/42/EC), and ensure that you understand them.

After completing the installation work, hand over this Installation Manual as well as the Owner's Manual provided to the user, and ask the user to keep them in a safe place for future reference.

Generic Denomination: Air Conditioner

Definition of Qualified Installer or Qualified Service Person

The air conditioner must be installed, maintained, repaired and removed by a qualified installer or qualified service person. When any of these jobs is to be done, ask a qualified installer or qualified service person to do them for you. A qualified installer or qualified service person is an agent who has the qualifications and knowledge described in the following table.

Agent	Qualifications and knowledge which the agent must have
Qualified installer	<ul style="list-style-type: none"> • The qualified installer is a person who installs, maintains, relocates and removes the air conditioners made by Toshiba Carrier Corporation. He or she has been trained to install, maintain, relocate and remove the air conditioners made by Toshiba Carrier Corporation or, alternatively, he or she has been instructed in such operations by an individual or individuals who have been trained and is thus thoroughly acquainted with the knowledge related to these operations. • The qualified installer who is allowed to do the electrical work involved in installation, relocation and removal has the qualifications pertaining to this electrical work as stipulated by the local laws and regulations, and he or she is a person who has been trained in matters relating to electrical work on the air conditioners made by Toshiba Carrier Corporation or, alternatively, he or she has been instructed in such matters by an individual or individuals who have been trained and is thus thoroughly acquainted with the knowledge related to this work. • The qualified installer who is allowed to do the refrigerant handling and piping work involved in installation, relocation and removal has the qualifications pertaining to this refrigerant handling and piping work as stipulated by the local laws and regulations, and he or she is a person who has been trained in matters relating to refrigerant handling and piping work on the air conditioners made by Toshiba Carrier Corporation or, alternatively, he or she has been instructed in such matters by an individual or individuals who have been trained and is thus thoroughly acquainted with the knowledge related to this work. • The qualified installer who is allowed to work at heights has been trained in matters relating to working at heights with the air conditioners made by Toshiba Carrier Corporation or, alternatively, he or she has been instructed in such matters by an individual or individuals who have been trained and is thus thoroughly acquainted with the knowledge related to this work.
Qualified service person	<ul style="list-style-type: none"> • The qualified service person is a person who installs, repairs, maintains, relocates and removes the air conditioners made by Toshiba Carrier Corporation. He or she has been trained to install, repair, maintain, relocate and remove the air conditioners made by Toshiba Carrier Corporation or, alternatively, he or she has been instructed in such operations by an individual or individuals who have been trained and is thus thoroughly acquainted with the knowledge related to these operations. • The qualified service person who is allowed to do the electrical work involved in installation, repair, relocation and removal has the qualifications pertaining to this electrical work as stipulated by the local laws and regulations, and he or she is a person who has been trained in matters relating to electrical work on the air conditioners made by Toshiba Carrier Corporation or, alternatively, he or she has been instructed in such matters by an individual or individuals who have been trained and is thus thoroughly acquainted with the knowledge related to this work. • The qualified service person who is allowed to do the refrigerant handling and piping work involved in installation, repair, relocation and removal has the qualifications pertaining to this refrigerant handling and piping work as stipulated by the local laws and regulations, and he or she is a person who has been trained in matters relating to refrigerant handling and piping work on the air conditioners made by Toshiba Carrier Corporation or, alternatively, he or she has been instructed in such matters by an individual or individuals who have been trained and is thus thoroughly acquainted with the knowledge related to this work. • The qualified service person who is allowed to work at heights has been trained in matters relating to working at heights with the air conditioners made by Toshiba Carrier Corporation or, alternatively, he or she has been instructed in such matters by an individual or individuals who have been trained and is thus thoroughly acquainted with the knowledge related to this work.

Definition of Protective Gear



When the air conditioner is to be transported, installed, maintained, repaired or removed, wear protective gloves and 'safety' work clothing.

In addition to such normal protective gear, wear the protective gear described below when undertaking the special work detailed in the following table.

Failure to wear the proper protective gear is dangerous because you will be more susceptible to injury, burns, electric shocks and other injuries.





Work undertaken	Protective gear worn
All types of work	Protective gloves 'Safety' working clothing
Electrical-related work	Gloves to provide protection for electricians and from heat Insulating shoes Clothing to provide protection from electric shock
Work done at heights (50 cm or more)	Helmets for use in industry
Transportation of heavy objects	Shoes with additional protective toe cap
Repair of outdoor unit	Gloves to provide protection for electricians and from heat

These safety cautions describe important matters concerning safety to prevent injury to users or other people and damages to property. Please read through this manual after understanding the contents below (meanings of indications), and be sure to follow the description.

Indication	Meaning of Indication
 WARNING	Text set off in this manner indicates that failure to adhere to the directions in the warning could result in serious bodily harm (*1) or loss of life if the product is handled improperly.
 CAUTION	Text set off in this manner indicates that failure to adhere to the directions in the caution could result in slight injury (*2) or damage (*3) to property if the product is handled improperly.

- *1: Serious bodily harm indicates loss of eyesight, injury, burns, electric shock, bone fracture, poisoning, and other injuries which leave aftereffect and require hospitalization or long-term treatment as an outpatient.
- *2: Slight injury indicates injury, burns, electric shock, and other injuries which do not require hospitalization or long-term treatment as an outpatient.
- *3: Damage to property indicates damage extending to buildings, household effects, domestic livestock, and pets.

MEANINGS OF SYMBOLS DISPLAYED ON THE UNIT

	WARNING (Risk of fire)	This mark is for R32 refrigerant only. Refrigerant type is written on nameplate of outdoor unit. In case that refrigerant type is R32, this unit uses a flammable refrigerant. If refrigerant leaks and comes in contact with fire or heating part, it will create harmful gas and there is risk of fire.
		Read the OWNER'S MANUAL carefully before operation.
		Service personnel are required to carefully read the OWNER'S MANUAL and INSTALLATION MANUAL before operation.
		Further information is available in the OWNER'S MANUAL, INSTALLATION MANUAL, and the like.



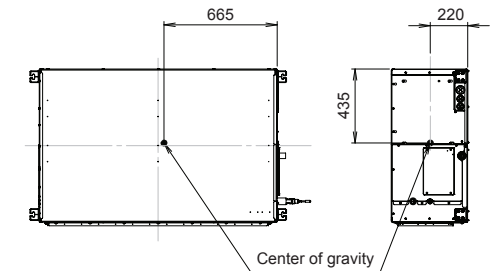

■ Center of gravity

(Unit: mm)

Use forklift to carry in the air conditioner units and use winch or hoist at installation of them.



■ Warning indications on the air conditioner unit

Warning indication		Description
 <p>WARNING ELECTRICAL SHOCK HAZARD Disconnect all remote electric power supplies before servicing.</p>	<p>WARNING ELECTRICAL SHOCK HAZARD Disconnect all remote electric power supplies before servicing.</p>	
 <p>WARNING Moving parts. Do not operate unit with grille removed. Stop the unit before the servicing.</p>	<p>WARNING Moving parts. Do not operate unit with grille removed. Stop the unit before the servicing.</p>	
 <p>CAUTION High temperature parts. You might get burned when removing this panel.</p>	<p>CAUTION High temperature parts. You might get burned when removing this panel.</p>	
 <p>CAUTION Do not touch the aluminum fins of the unit. Doing so may result in injury.</p>	<p>CAUTION Do not touch the aluminium fins of the unit. Doing so may result in injury.</p>	
 <p>CAUTION BURST HAZARD Open the service valves before the operation, otherwise there might be the burst.</p>	<p>CAUTION BURST HAZARD Open the service valves before the operation, otherwise there might be the burst.</p>	

1 Precautions for safety

The manufacturer shall not assume any liability for the damage caused by not observing the description of this manual.

WARNING

General

- Before starting to install the air conditioner, read through the Installation Manual carefully, and follow its instructions to install the air conditioner.
- Only a qualified installer or service person is allowed to do installation work. Inappropriate installation may result in water leakage, electric shock or fire.
- Do not use any refrigerant different from the one specified for complement or replacement. Otherwise, abnormally high pressure may be generated in the refrigeration cycle, which may result in a failure or explosion of the product or an injury to your body.
- Before opening the electrical control box cover of the indoor unit or service panel of the outdoor unit, set the circuit breaker to the OFF position. Failure to set the circuit breaker to the OFF position may result in electric shocks through contact with the interior parts. Only a qualified installer(*1) or qualified service person(*1) is allowed to remove the electrical control box cover of the indoor unit or service panel of the outdoor unit and do the work required.
- Before carrying out the installation, maintenance, repair or removal work, be sure to set the circuit breaker to the OFF position. Otherwise, electric shocks may result.
- Place a “Work in progress” sign near the circuit breaker while the installation, maintenance, repair or removal work is being carried out. There is a danger of electric shocks if the circuit breaker is set to ON by mistake.

- Only a qualified installer(*1) or qualified service person(*1) is allowed to undertake work at heights using a stand of 50 cm or more or to remove the intake grille of the indoor unit to undertake work.
- Wear protective gloves and safety work clothing during installation, servicing and removal.
- Do not touch the aluminium fin of the unit. You may injure yourself if you do so. If the fin must be touched for some reason, first put on protective gloves and safety work clothing, and then proceed.
- Before opening the suction board cover, set the circuit breaker to the OFF position. Failure to set the circuit breaker to the OFF position may result in injury through contact with the rotation parts. Only a qualified installer (*1) or qualified service person (*1) is allowed to remove the suction board cover and do the work required.
- When work is performed at heights, use a ladder which complies with the ISO 14122 standard, and follow the procedure in the ladder's instructions. Also wear a helmet for use in industry as protective gear to undertake the work.
- Before cleaning the filter or other parts of the outdoor unit, set the circuit breaker to OFF without fail, and place a "Work in progress" sign near the circuit breaker before proceeding with the work.
- Before working at heights, put a sign in place so that no-one will approach the work location, before proceeding with the work. Parts and other objects may fall from above, possibly injuring a person below. While carrying out the work, wear a helmet for protection from falling objects.
- Do not use the refrigerant other than R32 or R410A.
For the refrigerant type, check the outdoor unit to be combined.

- The refrigerant used by this air conditioner, follow to the outdoor unit.
- The air conditioner must be transported in stable condition. If any part of the product is broken, contact the dealer.
- When carrying the Air Conditioner, be sure to use a forklift. If it is necessary to carry by hands, be sure to carry it with more than 4 people and only for a short time shall be allowed to do so.
- Do not move or repair any unit by yourself. There is high voltage inside the unit. You may get electric shock when removing the cover and main unit.
- This appliance is intended to be used by expert or trained users in shops, in light industry, or for commercial use by lay persons.

Selection of installation location

- When the air conditioner is installed in a small room, provide appropriate measures to ensure that the concentration of refrigerant leakage occur in the room does not exceed the critical level.
- Do not install in a location where flammable gas leaks are possible. If the gas leak and accumulate around the unit, it may ignite and cause a fire.
- To transport the air conditioner, wear shoes with additional protective toe caps.
- To transport the air conditioner, do not take hold of the bands around the packing carton. You may injure yourself if the bands should break.
- Install the indoor unit at least 2.5 m above the floor level since otherwise the users may injure themselves or receive electric shocks if they poke their fingers or other objects into the indoor unit while the air conditioner is running.

- Do not place any combustion appliance in a place where it is directly exposed to the wind of air conditioner, otherwise it may cause imperfect combustion.
- Appliance and pipe-work shall be installed, operated and stored in a room with a floor area larger than $A_{\min} \text{ m}^2$.
How to get $A_{\min} \text{ m}^2$: $A_{\min} = (M / (2.5 \times 0.22759 \times h_0))^2$
M is the refrigerant charge amount in appliance in **kg**;
 h_0 is the installation height of the appliance in **m**:
0.6 m for floor standing / 1.8 m for wall mounted / 1.0 m for window mounted / 2.2 m for ceiling mounted.
(R32 refrigerant models only. For detail, refer to Installation Manual of the outdoor unit.)

Installation

- When the indoor unit is to be suspended, the designated hanging bolts (M10 or W3/8) and nuts (M10 or W3/8) must be used.
- Install the air conditioner securely in a location where the base can sustain the weight adequately. If the strength is not enough, the unit may fall down resulting in injury.
- Follow the instructions in the Installation Manual to install the air conditioner. Failure to follow these instructions may cause the product to fall down or topple over or give rise to noise, vibration, water leakage or other trouble.
- Carry out the specified installation work to guard against the possibility of high winds and earthquake. If the air conditioner is not installed appropriately, a unit may topple over or fall down, causing an accident.
- If refrigerant gas has leaked during the installation work, ventilate the room immediately. If the leaked refrigerant gas comes in contact with fire, noxious gas may generate.
- Use forklift to carry in the air conditioner units and use winch or hoist at installation of them.

- Suction duct length must be longer than 850 mm.
- Helmet must be worn to protect your head from falling objects. Especially, when you work under an inspection opening, helmet must be worn to protect your head from falling objects from the opening.

Refrigerant piping

- Install the refrigerant pipe securely during the installation work before operating the air conditioner. If the compressor is operated with the valve open and without refrigerant pipe, the compressor sucks air and the refrigeration cycles is over pressurized, which may cause a injury.
- Tighten the flare nut with a torque wrench in the specified manner. Excessive tighten of the flare nut may cause a crack in the flare nut after a long period, which may result in refrigerant leakage.
- After the installation work, confirm that refrigerant gas does not leak. If refrigerant gas leaks into the room and flows near a fire source, such as a cooking range, noxious gas may be generated.
- When the air conditioner has been installed or relocated, follow the instructions in the Installation Manual and purge the air completely so that no gases other than the refrigerant will be mixed in the refrigerating cycle. Failure to purge the air completely may cause the air conditioner to malfunction.
- Nitrogen gas must be used for the airtight test.
- The charge hose must be connected in such a way that it is not slack.

Electrical wiring

- Only a qualified installer(*1) or qualified service person(*1) is allowed to carry out the electrical work of the air conditioner. Under no circumstances must this work be done by an unqualified individual since failure to carry out the work properly may result in electric shocks and/or electrical leaks.
- To connect the electrical wires, repair the electrical parts or undertake other electrical jobs, wear gloves to provide protection for electricians, insulating shoes and clothing to provide protection from electric shocks. Failure to wear this protective gear may result in electric shocks.
- Use wiring that meets the specifications in the Installation Manual and the stipulations in the local regulations and laws. Use of wiring which does not meet the specifications may give rise to electric shocks, electrical leakage, smoking and/or a fire.
- Connect earth wire. (Grounding work)
Incomplete grounding causes an electric shock.
- Do not connect earth wires to gas pipes, water pipes, and lightning conductor or telephone earth wires.
- After completing the repair or relocation work, check that the earth wires are connected properly.
- Install a circuit breaker that meets the specifications in the installation manual and the stipulations in the local regulations and laws.
- Install the circuit breaker where it can be easily accessed by the agent.
- When installing the circuit breaker outdoors, install one which is designed to be used outdoors.
- Under no circumstances the power wire must not be extended. Connection trouble in the places where the wire is extended may give rise to smoking and/or a fire.

- Electrical wiring work shall be conducted according to law and regulation in the community and installation manual. Failure to do so may result in electrocution or short circuit.

Test run

- Before operating the air conditioner after having completed the work, check that the electrical control box cover of the indoor unit and service panel of the outdoor unit are closed, and set the circuit breaker to the ON position. You may receive an electric shock if the power is turned on without first conducting these checks.
- If there is any kind of trouble (such as an error display has appeared, smell of burning, abnormal sounds, the air conditioner fails to cool or heat or water is leaking) has occurred in the air conditioner, do not touch the air conditioner yourself but set the circuit breaker to the OFF position, and contact a qualified service person. Take steps to ensure that the power will not be turned on (by marking "out of service" near the circuit breaker, for instance) until qualified service person arrives. Continuing to use the air conditioner in the trouble status may cause mechanical problems to escalate or result in electric shocks or other trouble.
- After the work has finished, use an insulation tester set (500 V Megger) to check the resistance is 1 MΩ or more between the charge section and the non-charge metal section (Earth section). If the resistance value is low, a disaster such as a leak or electric shock is caused at user's side.
- Upon completion of the installation work, check for refrigerant leaks and check the insulation resistance and water drainage. Then conduct a test run to check that the air conditioner is operating properly.

Explanations given to user

- Upon completion of the installation work, tell the user where the circuit breaker is located. If the user does not know where the circuit breaker is, he or she will not be able to turn it off in the event that trouble has occurred in the air conditioner.
- After the installation work, follow the Owner's Manual to explain to the customer how to use and maintain the unit.

Relocation

- Only a qualified installer(*1) or qualified service person(*1) is allowed to relocate the air conditioner. It is dangerous for the air conditioner to be relocated by an unqualified individual since a fire, electric shocks, injury, water leakage, noise and/or vibration may result.
- When carrying out the pump-down work shut down the compressor before disconnecting the refrigerant pipe. Disconnecting the refrigerant pipe with the service valve left open and the compressor still operating will cause air or other gas to be sucked in, raising the pressure inside the refrigeration cycle to an abnormally high level, and possibly resulting in rupture, injury or other trouble.

CAUTION









This Air Conditioner has adopted a refrigerant HFC (R32 or R410A) which does not destroy the ozone layer.

- As the R32 or R410A refrigerant is easily affected by impurities such as moisture, oxidized film, oil, etc., due to the high pressure, be careful not to allow the moisture, dirt, existing refrigerant, refrigerating machine oil, etc., to get mixed up in the refrigeration cycle during the installation work.
- A special tool for the R32 or R410A refrigerant is required for installation.
- Use a new and clean piping materials for the connecting pipe so that moisture and dirt are not mixed together during the installation work.
- When using existing pipes, follow the installation manual enclosed with the outdoor unit.

(*1) Refer to the "Definition of Qualified Installer or Qualified Service Person."

2 Accessory parts

■ Accessory parts

Part name	Q'ty	Shape	Usage
Installation Manual	1	This manual	(Hand over to customers) (For other languages that do not appear in this Installation Manual, please refer to the enclosed CD-R.)
Owner's Manual	1		(Hand over to customers) (For other languages that do not appear in this Owner's Manual, please refer to the enclosed CD-R.)
CD-ROM	1	—	Owner's Manual and Installation Manual
Heat insulator	2	 (200×200×6t)	For heat insulation of gas pipe and liquid pipe connecting section
Washer	8		For hanging-down unit
Hose band	1		For connecting drain pipe
Flexible hose	1		For adjusting center of drain pipe
Heat insulator	1	 (220×300×10t)	For heat insulation of drain connecting section
Joint (Ø22.2 – Ø28.6 mm)	1		For connecting the gas side pipe
Seal material	3	 (45×45×3t)	For sealing of wire connecting port

3 Selection of installation place

Avoid installing in the following places

Select a location for the indoor unit where the cool or warm air will circulate evenly.

Avoid installation in the following kinds of locations.

- Saline area (coastal area)
- Locations with acidic or alkaline atmospheres (such as areas with hot springs, factories where chemicals or pharmaceuticals are made and places where the exhaust air from combustion appliances will be sucked into the unit).
Doing so may cause the heat exchanger (its aluminum fins and copper pipes) and other parts to become corroded.
- Locations with atmospheres with mist of cutting oil or other types of machine oil.
Doing so may cause the heat exchanger to become corroded, mists caused by the blockage of the heat exchanger to be generated, the plastic parts to be damaged, the heat insulators to peel off, and other such problems to result.
- Places where iron or other metal dust is present. If iron or other metal dust adheres to or collects on the interior of the air conditioner, it may spontaneously combust and start a fire.
- Locations where vapors from food oils are formed (such as kitchens where food oils are used).
Blocked filters may cause the air conditioner's performance to deteriorate, condensation to form, the plastic parts to be damaged, and other such problems to result.
- Locations near obstructions such as ventilation openings or lighting fixtures where the flow of the blown air will be disrupted (a disruption of the air flow may cause the air conditioner's performance to deteriorate or the unit to shut down).
- Locations where an in-house power generator is used for the power supply.
The power line frequency and voltage may fluctuate, and the air conditioner may not work properly as a result.
- On truck cranes, ships or other moving conveyances.
- The air conditioner must not be used for special applications (such as for storing food, plants, precision instruments or art works).
(The quality of the items stored may be degraded.)
- Locations where high frequencies are generated (by inverter equipment, in-house power generators, medical equipment or communication equipment).
(Malfunctioning or control trouble in the air conditioner or noise may adversely affect the equipment's operation.)
- Locations where there is anything under the unit installed that would be compromised by wetness.
(If the drain has become blocked or when the humidity is over 80 %, condensation from the indoor unit will drip, possibly causing damage to anything underneath.)
- In the case of the wireless type of system, rooms with the inverter type of fluorescent lighting or locations exposed to direct sunlight.
(The signals from the wireless remote controller may not be sensed.)
- Locations where organic solvents are being used.
- The air conditioner cannot be used for liquefied carbonic acid cooling or in chemical plants.
- Location near doors or windows where the air conditioner may come into contact with high-temperature, highhumidity outdoor air.
(Condensation may occur as a result.)
- Locations where special sprays are used frequently.
- Places with poor ventilation.

■ Installation under high-humidity atmosphere

In some cases including the rainy season, especially inside of the ceiling may become high-humidity atmosphere (dew-point temperature: 23 °C or higher).

1. Installation to inside of the ceiling with tiles on the roof
 2. Installation to inside of the ceiling with slated roof
 3. Installation to a place where inside of the ceiling is used for pathway to intake the fresh air
 4. Installation to a kitchen
- In the above cases, additionally attach the heat insulator to all positions of the air conditioner, which come to contact with the high-humidity atmosphere. In this case, arrange the side plate (Check port) so that it is easily removed.
 - Apply also a sufficient heat insulation to the duct and connecting part of the duct.

[Reference]	Condensation test conditions
Indoor side:	27 °C dry bulb temperature 24 °C wet bulb temperature
Air volume:	Low air volume, operation time 4 hours

■ Installation space

(Unit: mm)

Reserve sufficient space required for installation or service work.

Space required for installation and servicing

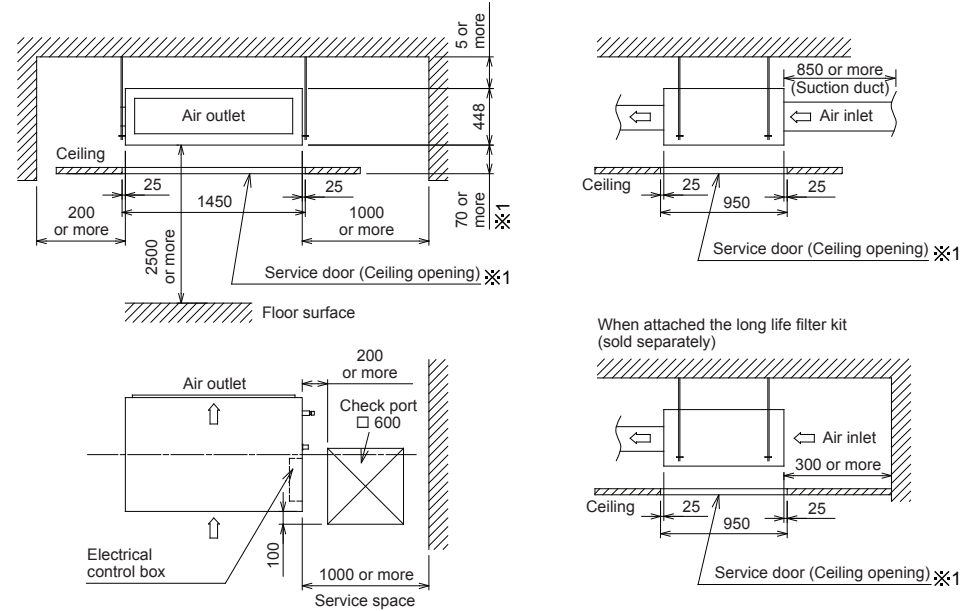

※1 If there are enough space under the unit (more than 1000mm) the service door (Ceiling opening) is not necessary.

■ Filter cleaning sign term setting

The lighting term setup of the filter sign (Notification of filter cleaning) of the remote controller can be changed according to the condition of installation.
For setup method, refer to "Filter sign setting" in the Applicable controls of this Manual.

4 Installation

⚠ CAUTION

Strictly comply with the following rules to prevent damage of the indoor units and human injury.

- Do not put a heavy article on the indoor unit or let a person get on it. (Even units are packaged)
- Carry in the indoor unit as it is packaged if possible. If carrying in the indoor unit unpacked by necessity, use buffering cloth or other material to not damage the unit.
- To move the indoor unit, hold the hooking brackets (4 positions) only.
Do not apply force to the other parts (such as refrigerant pipe, drain pan, foamed parts, or resin parts).
- Carry the package by four or more persons, and do not bundle it with plastic band at positions other than specified.
- To install vibration isolation material to hanging bolts, confirm that it does not increase the unit vibration.

■ External dimensions

(Unit: mm)

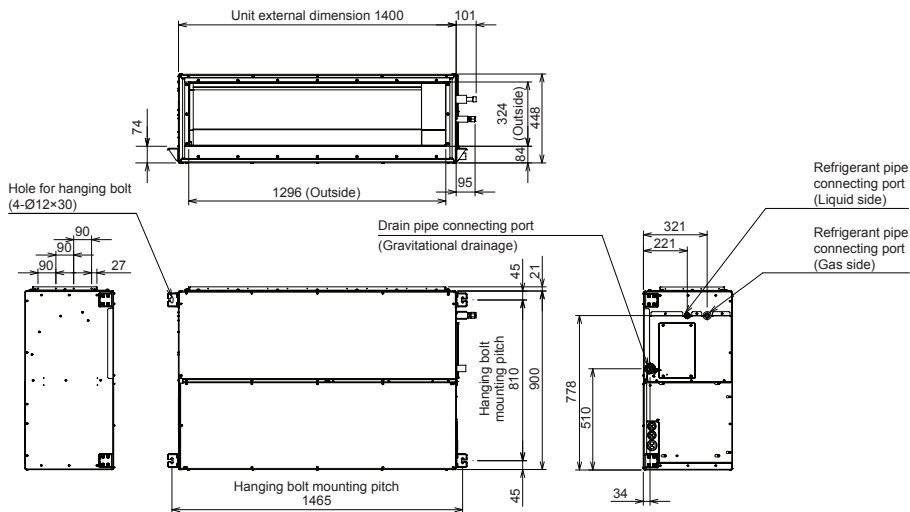

■ Installation of hanging bolt

- Consider the piping / wiring after the unit is hung to determine the location of the indoor unit installation and orientation.
- After the location of the indoor unit installation has been determined, install hanging bolts.
- For the dimensions of the hanging bolt pitches, refer to the external view.
- When a ceiling already exists, lay the drain pipe, refrigerant pipe, control wires, and remote controller wires to their connection locations before hanging the indoor unit.

Procure hanging bolts washer and nuts for installing the indoor unit (these are not supplied).

Hanging bolt	M10 or W3/8	4 pieces
Nut	M10 or W3/8	12 pieces
Washer	M10	8 pieces

Installation of hanging bolt

Use M10 hanging bolts (4 pcs, locally procured). Matching to the existing structure, set pitch according to size in the unit external view as shown below.

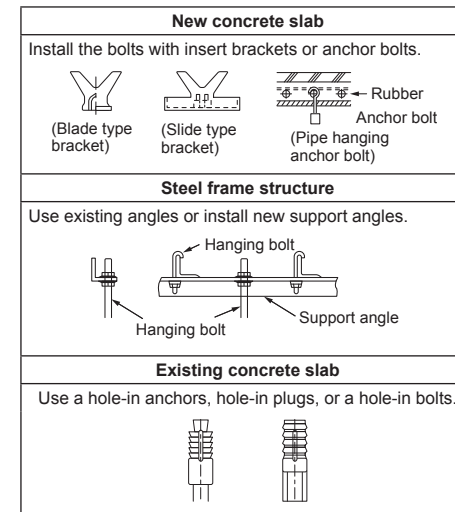

■ Installation of indoor unit

Treatment of ceiling

The ceiling differs according to structure of building. For details, consult your constructor or interior finish contractor.

In the process after the ceiling board has been removed, it is important to reinforce ceiling foundation (frame) and to keep horizontal level of installed ceiling correctly in order to prevent vibration of ceiling board.

- Attach the nuts and the M10 flat washers to the hanging bolt.
- Put washers at up and down of the hanging bracket of the indoor unit to hang down the indoor unit.
- Check that four sides are horizontal with a level gauge. (Horizontal degree: Within 5 mm)

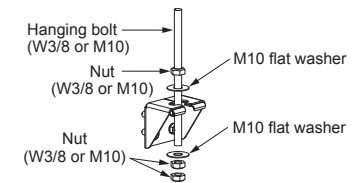

REQUIREMENT

- Hang the unit in a horizontal position. When unit is hung to slant, it may cause overflow of drainage.
- Install the unit within the dimension according to the figure below.
- Use level gauge to confirm whether the unit is hang horizontally.

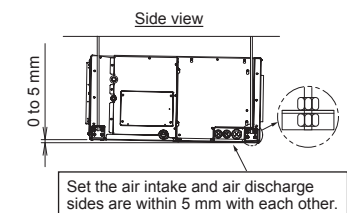
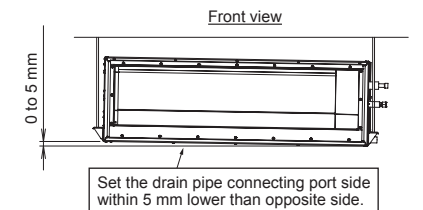

■ REQUIREMENT

Removing the cardboard for transportation

- Make sure to remove the protection cardboard for transportation that is inserted in the gap between the top cabinet and the heat exchanger before installing the indoor unit.

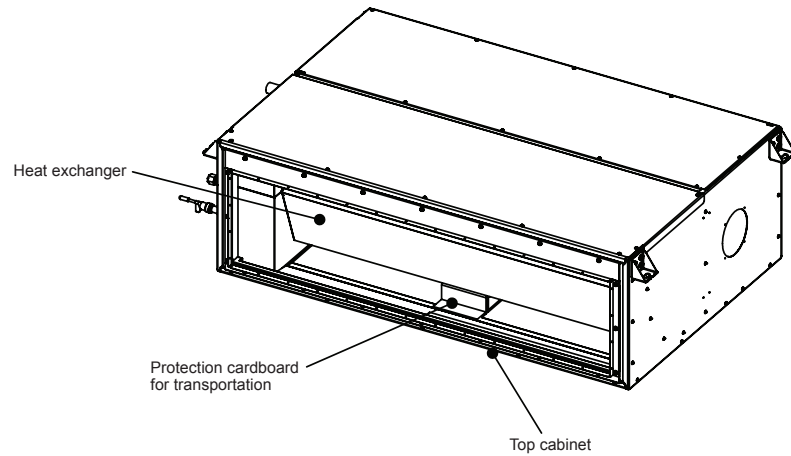

5 Drain piping

⚠ CAUTION

Following the Installation Manual, perform the drain piping work so that water is properly drained. Apply a heat insulation so as not to cause a dew condensation. Inappropriate piping work may result in water leakage in the room and wet furniture.

- Provide the indoor drain piping with proper heat insulation.
- Provide the area where the pipe connects to the indoor unit with proper heat insulation. Improper heat insulation will cause condensation to form.
- The drain pipe must be sloping downward (at an angle of 1/100 or more), and do not run the pipe up and down (arched shape) or allow it to form traps. Doing so may cause abnormal sounds.
- Restrict the length of the traversing drain pipe to 20 meters or less. For a long pipe, provide support brackets at intervals of 1.5 to 2 meters to prevent flapping.
- Install the collective piping as shown in the following figure.
- Do not provide any air vents. Otherwise, the drain water will spout, causing water to leak.
- Do not allow any force to be applied to the connection area with the drain pipe.

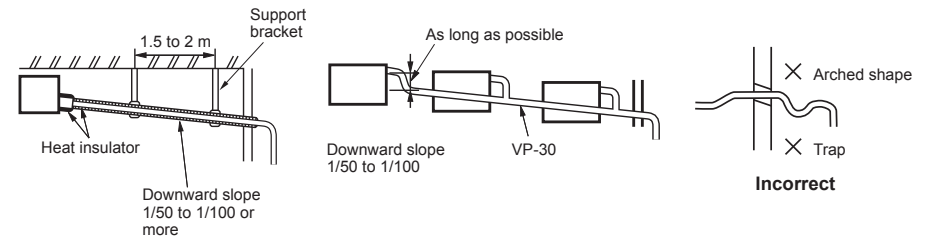

■ Pipe material, size and insulator

The following materials for piping work and insulating process are locally procured.

Pipe material	Hard vinyl chloride pipe VP25 (Nominal outer diameter Ø32 mm)
Insulator	Foamed polyethylene foam, thickness: 10 mm or more

■ Connecting drain pipe

Insert flexible drain hose into the drain pipe of main unit as far as it will go. Fix it with hose band.

REQUIREMENT

Mount the flexible drain hose using the hose band without using adhesive.

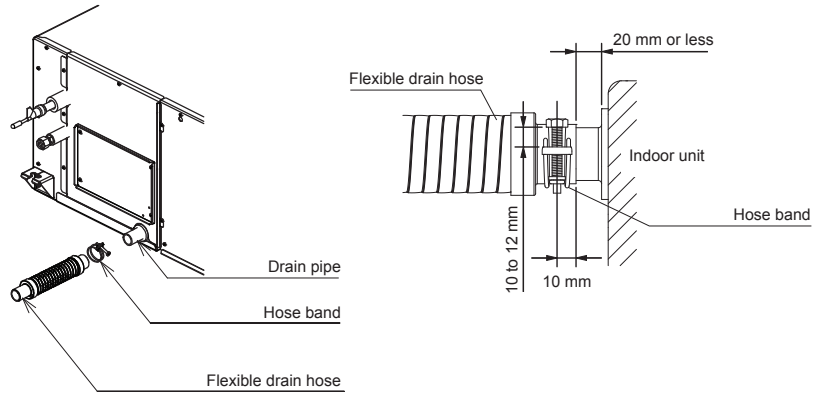

■ Drain up

When install the drain pump kit (TCB-DP40DPE) of optional accessory, read the Installation Manual supplied to a drain pump kit.

■ Check the draining

Check if the water can flow out properly during the test run. Also, check if no water leakage from the piping connection port.

REQUIREMENT

- Conduct the drain test even in the heating season.
- If it is before the duct work, pour water into the drain pan through the air outlet.
- If it is after the duct work, remove the access panel and pour water, then conduct the drain check.

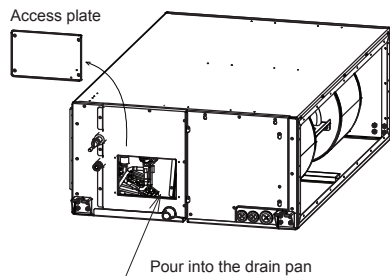

■ Heat insulating process

- As shown in the figure, cover the flexible hose and hose band with the attached heat insulator up to the bottom of the indoor unit tightly.
- Cover the drain pipe tightly with a heat insulator procured locally so that it overlaps with the attached heat insulator of the drain connecting section.

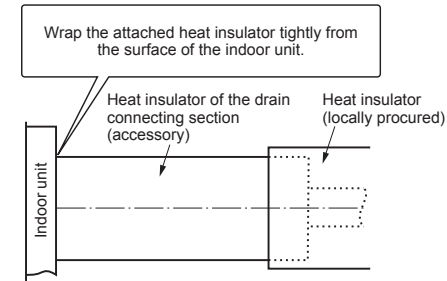

■ Connecting method of the duct

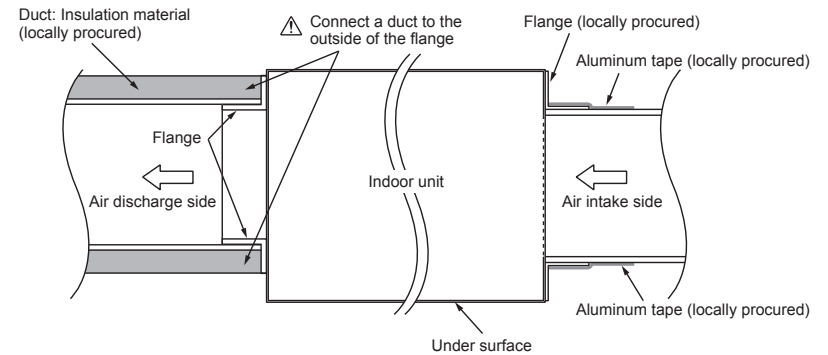

⚠ CAUTION

Incomplete heat insulation of the supply air flange and sealing may occur dewing resulted in falling of water drop.

Fan characteristics

RM224 type

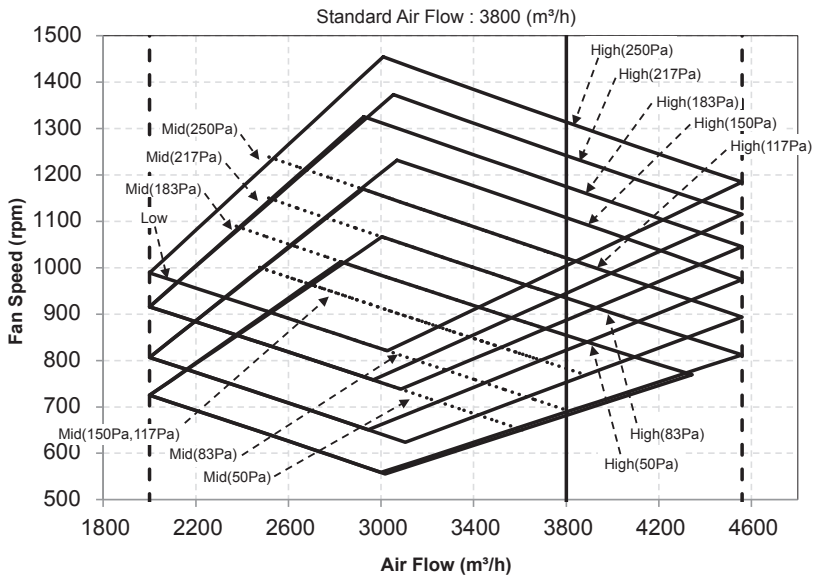
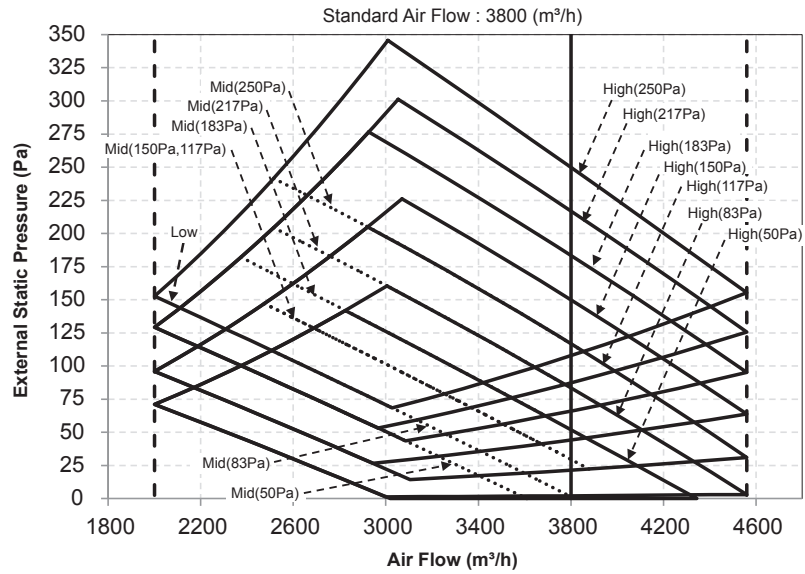

RM280 type

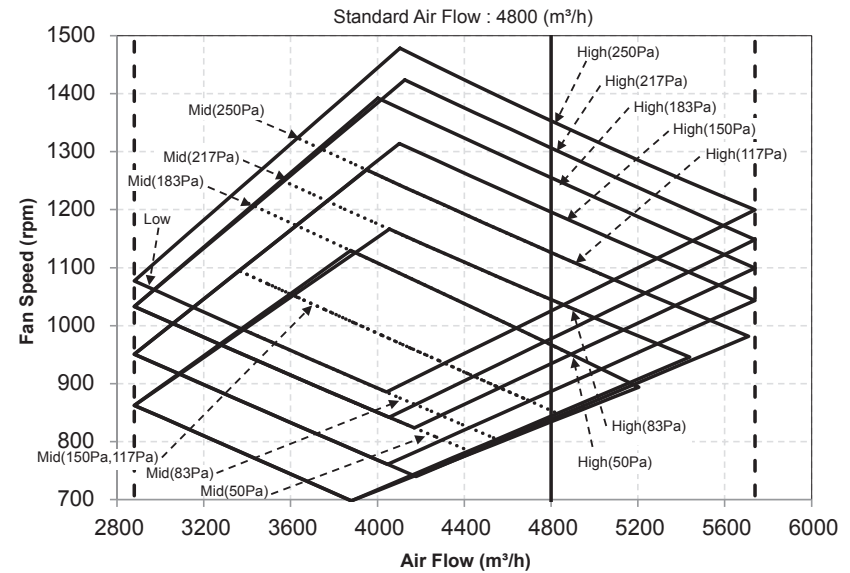
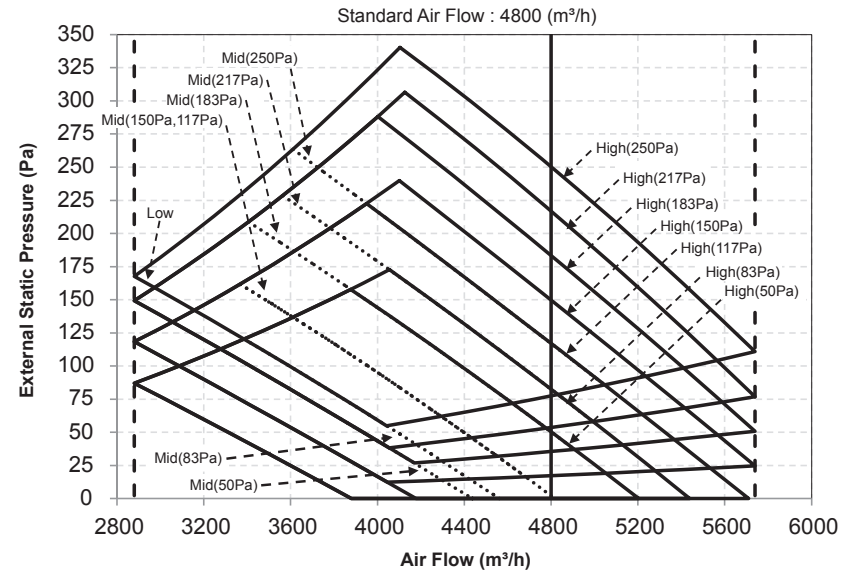

6 Duct design

■ Duct design

1 In order to prevent short circuits, design the duct work so that the intake and discharge openings are not adjacent to each other.

2 The indoor unit does not have a built-in air filter.

Always install the air filter (Local procure) in a location that permits easy maintenance, such as behind the intake grille. (If no air filter is installed, dust will collect in the heat exchanger, which may cause the air conditioner to fail or to leak.)

<Overview of duct connection>

NOTE

Parts except air conditioner unit are to be locally procured.

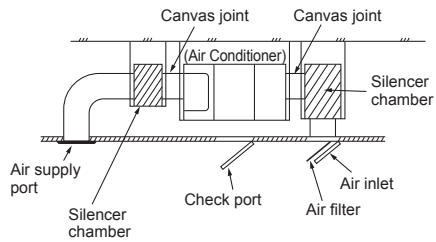

■ Arrangement

Referring to the following dimensions, manufacture duct at the local site.

(Unit: mm)

(Thickness of plate : 0.8 mm)

<Air outlet>

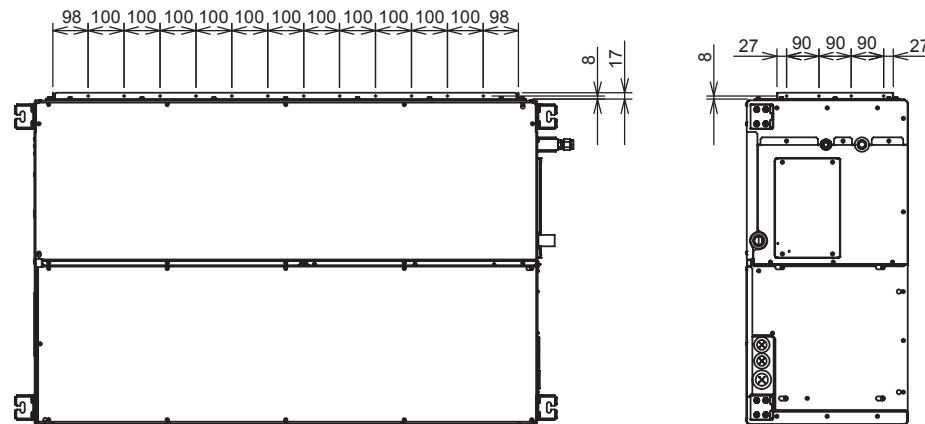
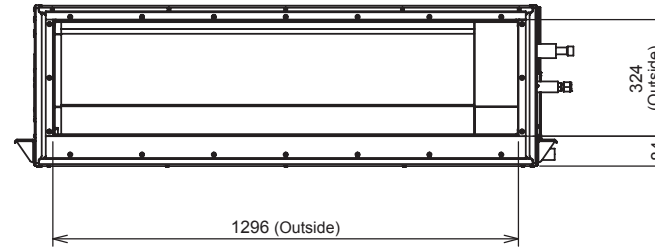

<Air inlet>

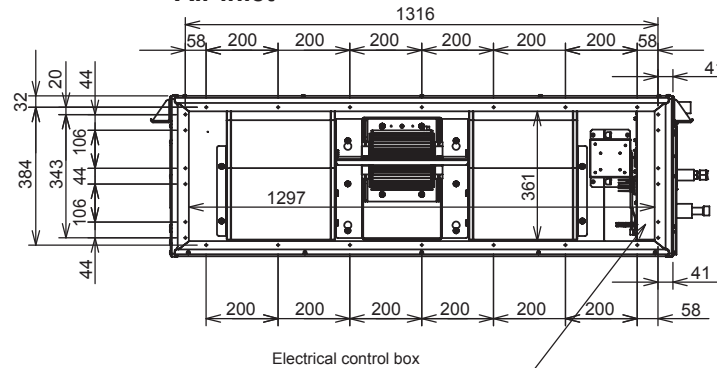

Electrical control box

7 Refrigerant piping

Refrigerant piping

- Use the following items for the refrigerant piping.

Material : Seamless phosphorous deoxidized copper pipe.

Wall thickness : 0.8 mm or more Ø12.7 mm (C1220T-0)
1.0 mm or more for Ø28.6 mm (C1220T-1/2H).

Do not use any copper pipes with a wall thickness less than these thicknesses.

- Flare nut and flare works are also different from those of the conventional refrigerant.

Take out the flare nut attached to the main unit of the air conditioner, and use it.

REQUIREMENT

When the refrigerant pipe is long, provide support brackets at intervals of 2.5 to 3 m to clamp the refrigerant pipe. Otherwise, abnormal sound may be generated.

CAUTION

Important 4 points for piping work

- Remove dust and moisture from the inside of the connecting pipes.
- Tight connection (between pipes and unit)
- Evacuate the air in the connecting pipes using VACUUM PUMP.
- Check the gas leakage. (Connected points)

Pipe size

Pipe size	Gas side	28.6 mm
	Liquid side	12.7 mm

Liquid side refrigerant pipe connection

Permissible piping length and height difference

They vary according to the outdoor unit. For details, refer to the Installation Manual attached to the outdoor unit.

Flaring

- Cut the pipe with a pipe cutter. Remove burrs completely. Remaining burrs may cause gas leakage.
- Insert a flare nut into the pipe, and flare the pipe. As the flaring sizes of R32 or R410A differ from those of refrigerant R22, the flare tools newly manufactured for R32 or R410A are recommended.

However, the conventional tools can be used by adjusting projection margin of the copper pipe.

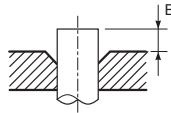

Projection margin in flaring: B (Unit: mm)

Rigid (Clutch type)

Outer dia. of copper pipe	Tool used	Conventional tool used
12.7	0 to 0.5	1.5 to 2.0

Flaring diameter size: A (Unit: mm)

Outer dia. of copper pipe	A $^{+0}_{-0.02}$ (-0.4)
12.7	16.6

- In case of flaring for R32 or R410A with the conventional flare tool, pull it out approx. 0.5 mm more than that for R22 to adjust to the specified flare size. The copper pipe gauge is useful for adjusting projection margin size.

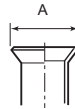

Tightening connection

CAUTION

Do not apply excessive torque. Otherwise, the nut may crack depending on the conditions.

(Unit: N·m)

Outer dia. of copper pipe	Tightening torque
12.7 mm (dia.)	50 to 62 (5.0 to 6.2 kgf·m)

Tightening torque of flare pipe connections

Pressure of R32 or R410A is higher than that of R22. (Approx. 1.6 times) Therefore, using a torque wrench, tighten the flare pipe connecting sections which connect the indoor and outdoor units of the specified tightening torque.

Incorrect connections may cause not only a gas leak, but also a trouble of the refrigeration cycle. Align the centres of the connecting pipes and tighten the flare nut as far as possible with your fingers. Then tighten the nut with a spanner and torque wrench as shown in the figure.

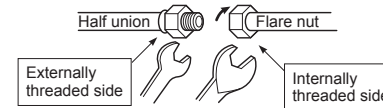

Use a wrench to secure. Use a torque wrench to tighten.

REQUIREMENT

Tightening with an excessive torque may crack the nut depending on installation conditions. Tighten the nut within the specified tightening torque.

Gas side refrigerant pipe connection

- Turn up the pipe heat insulator to the unit side.
- Wrap the pipe with wet cloth.

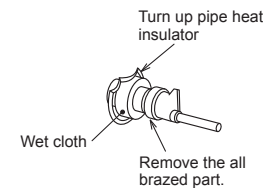

- Remove the cup on the gas side piping by using a brazing machine.

CAUTION

- Do not burn the pipe heat insulator.
- Be careful for the flame, due to the brazing process on the ceiling.

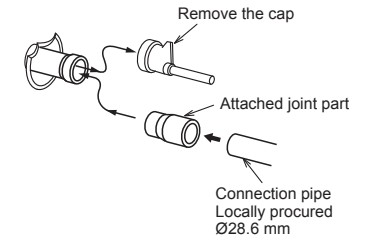

- Braze the attached joint part to the gas side piping and braze the connection piping to the joint part.

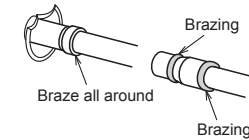

- Turn back the pipe heat insulator and tie up with a banding band.

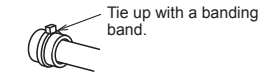

Piping with outdoor unit

For details of installation, refer to the Installation Manual of the outdoor unit.

Evacuation

Using a vacuum pump, perform vacuuming from the charge port of valve of the outdoor unit. For details, follow to the Installation Manual attached to the outdoor unit.

- Never use the refrigerant sealed in the outdoor unit for evacuation.

REQUIREMENT

For the tools such as charge hose, etc., use those manufactured exclusively for R32 or R410A.

Refrigerant amount to be added

For addition of the refrigerant, add refrigerant "R32 or R410A" referring to the attached Installation Manual of outdoor unit.
Use a scale to charge the refrigerant of specified amount.

REQUIREMENT

- Charging an excessive or too little amount of refrigerant causes a trouble of the compressor. Charge the refrigerant of specified amount.
- A personnel who charged the refrigerant should write down the pipe length and the added refrigerant amount in the F-GAS label of the outdoor unit. It is necessary to fix the compressor and refrigeration cycle malfunction.

Open the valve fully

Open the valve of the outdoor unit fully. A 4 mm-hexagonal wrench is required for opening the valve of liquid side.
For details, refer to the Installation Manual attached to the outdoor unit.

Gas leak check

Check with a leak detector or soap water whether gas leaks or not, from the pipe connecting section or cap of the valve.

REQUIREMENT

Use a leak detector manufactured exclusively for HFC refrigerant (R32, R134a, R410A, etc.).

Heat insulation process

Apply heat insulation for the pipes separately at liquid side and gas side.

- For the heat insulation to the pipes at gas side, be sure to use the material with heat-resisting temperature 120 °C or higher.
- To use the attached heat insulation pipe, apply the heat insulation to the pipe connecting section of the indoor unit securely without gap.

REQUIREMENT

- Apply the heat insulation to the pipe connecting section of the indoor unit securely up to the root without exposure of the pipe. (The pipe exposed to the outside causes water leak.)
- Apply heat insulating materials to both the gas side and liquid side as shown:

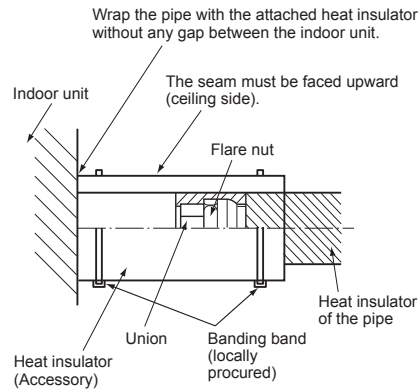

8 Electrical connection

⚠ WARNING

1. **Using the specified wires, ensure to connect the wires, and fix wires securely so that the external tension to the wires do not affect the connecting part of the terminals.**
Incomplete connection or fixation may cause a fire, etc.
2. **Be sure to connect earth wire. (grounding work)**
Incomplete grounding cause an electric shock.
Do not connect ground wires to gas pipes, water pipes, lightning rods or ground wires for telephone wires.
3. **Appliance shall be installed in accordance with national wiring regulations.**
Capacity shortage of power circuit or incomplete installation may cause an electric shock or a fire.

⚠ CAUTION

- If incorrect / incomplete wiring is carried out, it will cause an electrical fire or smoke.
- Be sure to install an earth leakage breaker that is not tripped by shock.
If an earth leakage breaker is not installed, an electric shock may be caused.
- Use the cord clamps attached to the product.
- Do not damage or scratch the conductive core and inner insulator of power and system interconnection wires when peeling them.
- Use the power cord and system interconnection wire of specified thickness, type, and protective devices required.
- Never connect 220–240 V power to the terminal blocks (A), (B), etc.) for control wiring. (Otherwise, the system will fail.)
- Perform the electric wiring so that it does not come to contact with the high-temperature part of the pipe.
The coating may melt resulting in an accident.

REQUIREMENT

- For power supply wiring, strictly conform to the Local Regulation in each country.
- Power supply for indoor unit must be exclusive and separated from the one for outdoor unit.
- For wiring of power supply of the outdoor units, follow the Installation Manual of each outdoor unit.
- After connecting wires to the terminal blocks, provide a trap and fix wires with the cord clamp.
- Run the refrigerant piping line and control wiring line in the same line.
- Do not turn on the power of the indoor unit until vacuuming of the refrigerant pipes completes.

■ Wiring

1. Figure below shows the wiring connections indoor power line and between the indoor and outdoor units and between the indoor units and remote controller.
The wires indicated by the dash lines are provided at the installation place.
2. Insulate the unsheathed redundant cords (conductors) with electrical insulation tape. Process them so that they do not touch any electrical or metal parts.

Wiring diagram

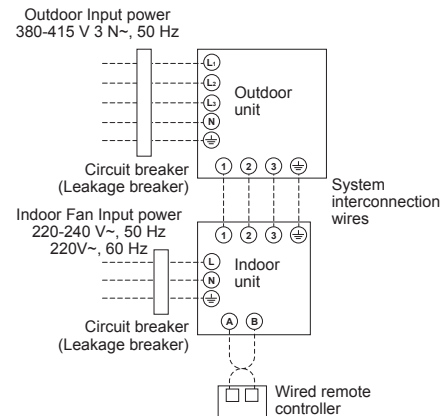

■ Power and wiring specification

Indoor fan power supply	220-240 V~, 50 Hz 220V~, 60 Hz
Maximum running current	6 A
Fuse rating	15 A
Indoor fan power supply wire*	3 x 2.5 mm ² or more (H07RN-F or 60245 IEC 57)
System interconnection wires*	4 x 1.5 mm ² or more (H07RN-F or 60245 IEC 57)

*Number of wire x wire size

Remote controller wiring

Remote controller wiring, remote controller inter-unit wiring	Wire size: 2 x 0.5 to 2.0 mm ²	
Total wire length of remote controller wiring and remote controller inter-unit wiring = L + L1 + L2 + ... Ln	In case of wired type only	Up to 500 m
	In case of wireless type included	Up to 400 m
Total wire length of remote controller inter-unit wiring = L1 + L2 + ... Ln		Up to 200 m

⚠ CAUTION

The remote controller wire and system interconnection wires cannot be parallel to contact each other and cannot be stored in the same conduits. If doing so, a trouble may be caused on the control system due to noise or other factor.

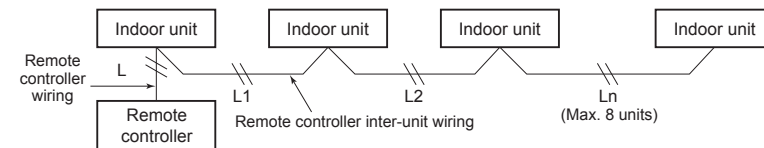

■ Wire connection

REQUIREMENT

- Be sure to connect the wires matching the terminal numbers. Incorrect connection causes a trouble.
- Be sure to pass the wires through the bushing of wire connection holes of the indoor unit.
- Keep a margin (Approx. 100 mm) on a wire to hang down the electrical control box at servicing, etc.
- The low-voltage circuit is provided for the remote controller. (Do not connect the high-voltage circuit)

- Before performing wiring work in the electrical control box, remove the cover of the box (fixed with 6 screws).
- Remove screw A, and loosen screw B.
- Pull up the electrical control box cover and then open it forward.
- Tighten the screws of the terminal block firmly, and fix the wires with the cord clamps attached to the electrical control box. (Do not apply tension to the connecting section of the terminal block.)
- Mount the cover of the electrical control box without pinching wires (fixed with 6 screws).
- Using the attached seal material, seal the wire connecting port.

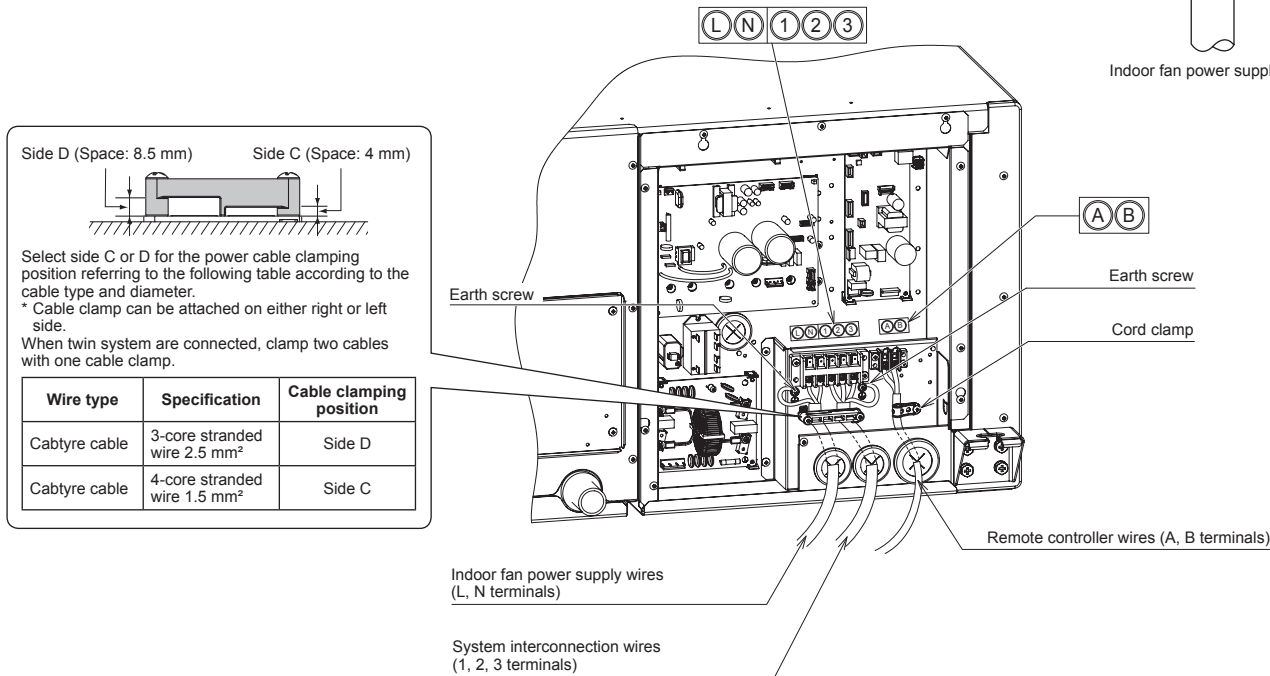
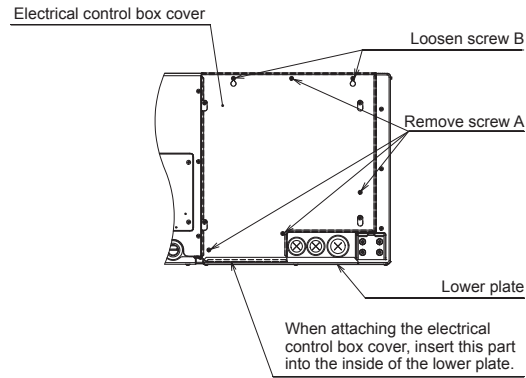

■ Remote controller wiring

- Strip off approx. 9 mm the wire to be connected.
- Non polarity, 2 core wire is used for wiring of the remote controller. (0.5 mm² to 2.0 mm² wires)

Wiring diagram

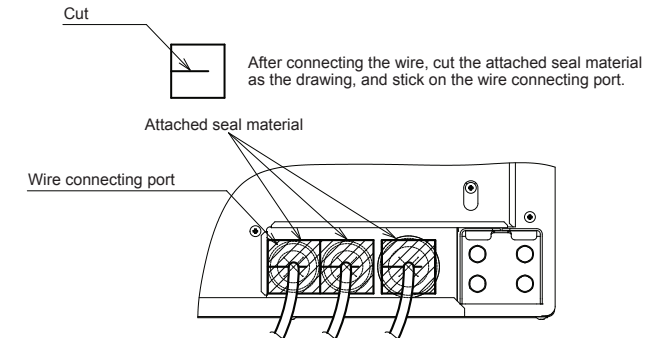
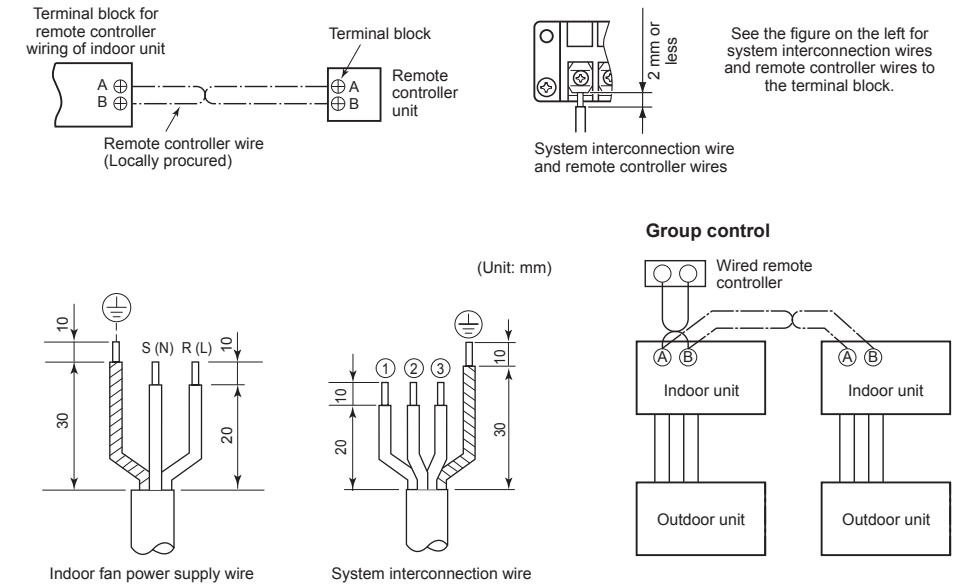

9 Applicable controls

REQUIREMENT

- When you use this air conditioner for the first time, it takes approx. 5 minutes until the remote controller becomes available after power-on. This is normal.

<When power is turned on for the first time after installation>

It takes **approx. 5 minutes** until the remote controller becomes available.

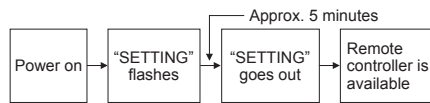

<When power is turned on for the second (or later) time>

It takes **approx. 1 minute** until the remote controller becomes available.

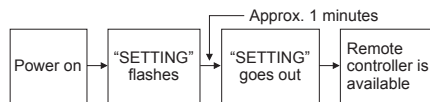

- Normal settings were made when the indoor unit was shipped from factory. Change the indoor unit settings as required.
- Use the wired remote controller to change the settings.
 - * The settings cannot be changed using the wireless remote controller, sub remote controller, or remote-controller-less system (for central remote controller only). Therefore, install the wired remote controller to change the settings.

Basic procedure for changing settings

Change the settings while the air conditioner is not working. **(Stop the air conditioner before making settings.)**

CAUTION

Set only the CODE No. shown in the following table: Do NOT set any other CODE No. If a CODE No. not listed is set, it may not be possible to operate the air conditioner or other trouble with the product may result.

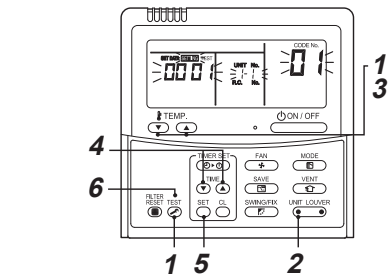

1 Push and hold **TEST** button and “TEMP.” button simultaneously for 4 seconds or more. After a while, the display flashes as shown in the figure. Confirm that the CODE No. is [01].

- If the CODE No. is not [01], push **TEST** button to clear the display content, and repeat the procedure from the beginning. (No operation of the **TEST** remote controller is accepted for a while after button is pushed.)
(While air conditioners are operated under the group control, “ALL” is displayed first. When **UNIT LOUVER** is pushed, the indoor unit number displayed following “ALL” is the header unit.)

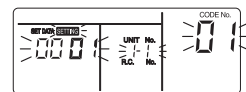

(* Display content varies with the indoor unit model.)

2 Each time **UNIT LOUVER** button is pushed, indoor unit numbers in the control group change cyclically. Select the indoor unit to change settings for.

The fan of the selected unit runs and the louvers start swinging. The indoor unit for change settings can be confirmed.

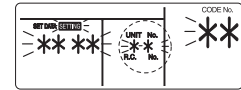

3 Specify CODE No. [**] with “TEMP.” button.

4 Select SET DATA [****] with “TIME” button.

5 Push **SET** button. When the display changes from flashing to lit, the setup is completed.

- To change settings of another indoor unit, repeat from Procedure 2.

- To change other settings of the selected indoor unit, repeat from Procedure 3.

Use **CL** button to clear the settings. To make settings after **CL** button was pushed, repeat from Procedure 2.

6 When settings have been completed, push **TEST** button to determine the settings.

When **TEST** button is pushed, **SETTING** flashes and then the display content disappears and the air conditioner enters the normal stop mode.

(While **SETTING** is flashing, no operation of the remote controller is accepted.)

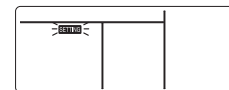

External static pressure settings

Set up a tap change based upon the external static pressure of the duct to be connected.

To set up a tap change, follow to the basic operation procedure (1 → 2 → 3 → 4 → 5 → 6).

- Specify [5d] to the CODE No. in procedure 3.
- For the SET DATA of procedure 4, select a SET DATA of the external static pressure to be set up from the following table.

<Change on wired remote controller>

SET DATA	External static pressure	
0000	150 Pa	Factory default
0001	50 Pa	—
0002	83 Pa	—
0003	217 Pa	—
0004	117 Pa	—
0005	183 Pa	—
0006	250 Pa	—

The list above is when SW501-1 and SW501-2 is OFF.

◆ Remote controller-less setting

To set up the external static pressure, use the DIP switch on the circuit board of the wireless reception part. For details, refer to the instruction manual of the wireless remote controller kit. Alternatively, use the switch on the indoor micro computer circuit board as shown in the following figure and table.

* Once switched, the settings "0001", "0003", and "0006" can be changed, but to reset to "0000", you need to set the switch to the normal (default) position and use a separately-sold wired remote controller to overwrite the data with "0000".

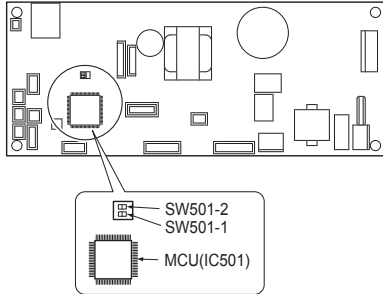

SW501-1	OFF	ON	OFF	ON
SW501-2	OFF	OFF	ON	ON
SET DATA	0000 (Factory default)	0001	0003	0006

To restore the factory defaults

To return the DIP switch settings to the factory defaults, set SW501-1 and SW501-2 to OFF, connect a separately sold wired remote controller, and then set the data of CODE No. [5d] to "0000".

■ Filter sign setting

According to the installation condition, the filter sign term (Notification of filter cleaning) can be changed.

Follow to the basic operation procedure (1 → 2 → 3 → 4 → 5 → 6).

- For the CODE No. in Procedure 3, specify [01].
- For the [SET DATA] in Procedure 4, select the SET DATA of filter sign term from the following table.

SET DATA	Filter sign term
0000	None
0001	150 H
0002	2500 H (Factory default)
0003	5000 H
0004	10000 H

■ To secure better effect of heating

When it is difficult to obtain satisfactory heating due to installation place of the indoor unit or structure of the room, the detection temperature of heating can be raised. Also use a circulator or other device to circulate heat air near the ceiling.

Follow to the basic operation procedure (1 → 2 → 3 → 4 → 5 → 6).

- For the CODE No. in Procedure 3, specify [06].
- For the SET DATA in Procedure 4, select the SET DATA of shift value of detection temperature to be set up from the following table.

SET DATA	Detection temperature shift value
0000	No shift
0001	+1 °C
0002	+2 °C (Factory default)
0003	+3 °C
0004	+4 °C
0005	+5 °C
0006	+6 °C

■ Power saving mode

Performing settings of the power saving mode

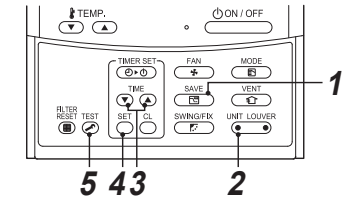

- 1 Push **SAVE** button for at least 4 seconds or more when the air conditioner is not working.

SETTING, symbol flashes.

- 2 Push **UNIT LOUVER** (left side of the button) to select an indoor unit to be set.

- Each time the button is pushed, UNIT No. change as follows:

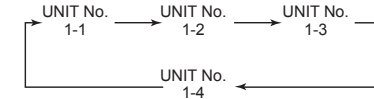

The fan of the selected unit runs.

- 3 Push **TIME** buttons, to adjust the setting of power level.

- Each push of the button changes the power level by 1% within the range from 100% to 50%.
- The factory default is 75%

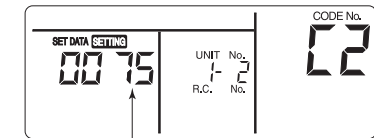

Setting of power level in power saving mode

- 4 Push **SET** button.

- 5 Push **TEST** button to complete the setting.

Remote controller switch monitoring function

This function is available to call the service monitor mode from the remote controller even during a test run to acquire temperatures of sensors of the remote controller, indoor unit, and outdoor unit.

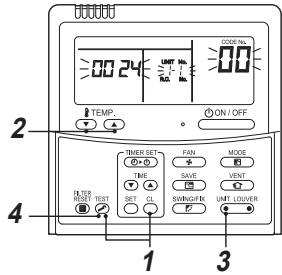

- 1 Push **CL.** and **TEST** buttons simultaneously for at least 4 seconds to call the service monitor mode. The service monitor indicator lights up and the header indoor unit number is displayed first. **CODE No.** **00** is also displayed.
- 2 Pushing **TEMP.** **▲** **▼** buttons, select the number of sensor, etc. (**CODE No.**) to be monitored. (See the following table.)
- 3 Pushing **UNIT LOUVER** (left side of the button), select an indoor unit to be monitored. The sensor temperatures of indoor units and their outdoor unit in the control group are displayed.

- 4 Push **TEST** button to return to the normal display.

Indoor unit data	
CODE No.	Data name
01	Room temperature (remote controller)
02	Indoor unit intake air temperature (TA)
03	Indoor unit heat exchanger (coil) temperature (TCJ)
04	Indoor unit heat exchanger (coil) temperature (TC)
F3	Filter sign time

Outdoor unit data	
CODE No.	Data name
60	Outdoor unit heat exchanger (coil) temperature (TE)
61	Outside air temperature (TO)
62	Compressor discharge temperature (TD)
63	Compressor suction temperature (TS)
64	—
65	Heatsink temperature (THS)
6A	Operating current (x1/10)
F1	Compressor cumulative operating hours (x100 h)

Group control

Group control for system of multiple units

One remote controller can control maximum 8 indoor units as a group.

Group control in single system

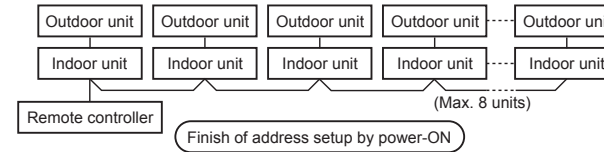

- For wiring procedure and wiring method of the individual line (Identical refrigerant line) system, follow to "Electrical connection".
- Wiring between lines is performed in the following procedure. Connect the terminal block (A/B) of the indoor unit connected with a remote controller to the terminal blocks (A/B) of the indoor units of other indoor units by wiring the inter-unit wire of the remote controller.
- When the power supply has been turned on, the automatic address setup starts and which indicates that address is being set up flashes on the display part in about 3 minutes. During setup of automatic address, the remote controller operation is not accepted.

Required time up to the finish of automatic addressing is approx. 5 minutes.

NOTE

In some cases, it is necessary to change the address manually after setup of the automatic address according to the system configuration of the group control.

Procedure example

Manual address setup procedure

While the operation stops, change the setup.
(Stop the operation of the unit.)

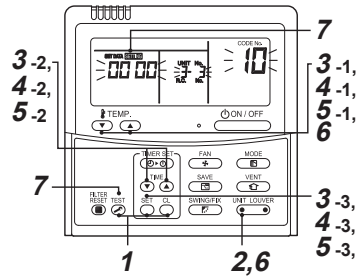

- 1** Push **SET** + **CL** + **TEST** buttons simultaneously for 4 seconds or more. After a while, the display part flashes as shown below. Check the displayed CODE No. is [10].

When the CODE No. is other than [10], push **TEST** button to clear the display and repeat procedure from the first step.

(After pushing **TEST** button, operation of the remote controller is not accepted for approx. 1 minute.)
(For a group control, No. of the firstly displayed indoor unit becomes the header unit.)

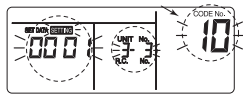

(* Display changes according to the model No. of indoor unit.)

- 2** Every time **UNIT LOUVER** button is pushed, the indoor UNIT No. in the group control is displayed in order. Select the indoor unit of which setup is changed.

In this time, the position of the indoor unit of which setup is changed can be confirmed because fan of the selected indoor unit operate.

3

- Specify CODE No. [12] with TEMP. ∇ / \blacktriangle buttons.
(CODE No. [12]: Line address)
- Change the line address from [3] to [2] with TIME ∇ / \blacktriangle buttons.
- Push **SET** button.
In this time, the setup finishes when the display changes from flashing to lighting.

Indoor UNIT No. before setup change is displayed.

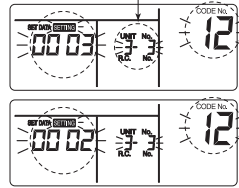

4

- Specify CODE No. [13] with TEMP. ∇ / \blacktriangle buttons.
(CODE No. [13]: Indoor address)
- Change the indoor address from [3] to [2] TIME ∇ / \blacktriangle buttons.
- Push **SET** button.
In this time, the setup finishes when the display changes from flashing to lighting.

Indoor UNIT No. before setup change is displayed.

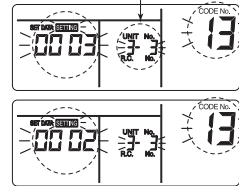

5

- Specify CODE No. [14] TEMP. ∇ / \blacktriangle buttons.
(CODE No. [14]: Group address)
- Change the SET DATA from [0001] to [0002] TIME ∇ / \blacktriangle buttons.
(SET DATA [Header unit: 0001] [Follower unit: 0002])
- Push **SET** button.
In this time, the setup finishes when the display changes from flashing to lighting.

Indoor UNIT No. before setup change is displayed.

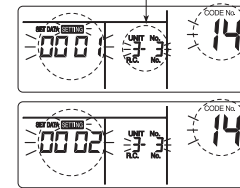

- 6** If there is other indoor unit to be changed, repeat procedure 2 to 5 to change the setup.

When the above setup has finished, push **UNIT LOUVER** button to select the indoor UNIT No. before change of setup, specify CODE No. [12], [13], [14] in order with TEMP. ∇ / \blacktriangle buttons, and then check the changed contents.

Address change check

Before change: [3-3-1] → After change: [2-2-2]

Pushing **CL** button clears the contents of which setup was changed.

(In this case, procedure from 2 is repeated.)

Indoor UNIT No. before setup change is displayed.

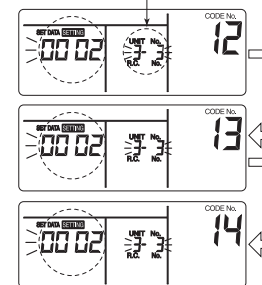

7

After check of the changed contents, push **TEST** button. (Setup is determined.) When **TEST** button is pushed, the display disappears and the status becomes the normal stopped state. (When **TEST** button is pushed the operation from the remote controller is not accepted for approx. 1 minute.)

- If the operation from the remote controller is not accepted even 1 minute or more passed after pushing **TEST** button, it is considered that the address setup is incorrect.

In this case, the automatic address must be again set up.
Therefore repeat procedure of the setup change from the Procedure 1.

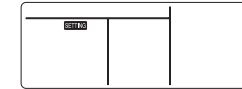

To recognize the position of the corresponding indoor unit through the indoor UNIT No. is known

Check the position during operation stop.
(Stop operation of the unit.)

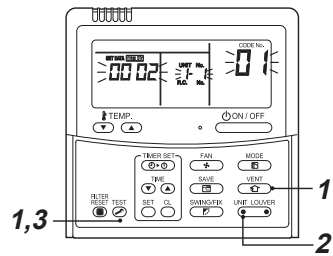

1 Push **TEST** + **VENT** buttons simultaneously for 4 seconds or more.

After a while, the display part flashes and the display appears as shown below. In this time, the position can be checked because fan of the indoor unit operate.

- For the group control, the indoor UNIT No. is displayed as [ALL] and fans of all the indoor units in the group control operate. Check the displayed CODE No. is [01].
- When the CODE No. is other than [01], push **TEST** button to clear the display and repeat procedure from the first step.
(After pushing **TEST** button, operation of the remote controller is not accepted for approx. 1 minute.)

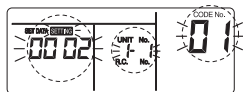

(* Display changes according to the model No. of indoor unit.)

2 In the group control, every time **UNIT LOUVER** button is pushed, the indoor UNIT No. in the group control is displayed in order.

In this time, the position of the indoor unit can be confirmed because only fan of the selected indoor unit operate.

(For a group control, No. of the firstly displayed indoor unit becomes the header unit.)

3 After confirmation, push **TEST** button to return to the normal mode.

When **TEST** button is pushed, the display disappears and the status becomes the normal stopped state.

(When **TEST** button is pushed the operation from the remote controller is not accepted for approx. 1 minute.)

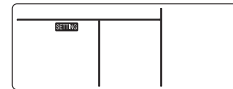

■ 8 °C Operation

Pre-heating operation can be set for cold regions where room temperature drops to below zero.

1 Push **SET** + **CL** + **TEST** buttons simultaneously for 4 seconds or more when the air conditioner is not working.

After a while, the display part flashes as shown below. Check the Displayed CODE No. is [10].

- When the CODE No. is other than [10], push **TEST** button to erase the display and repeat procedure from the first step.
(After pushing **TEST** button, operation of the remote controller is not accepted for approx. 1 minute.)

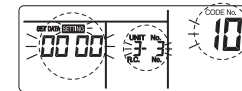

(* Display changes according to the model No. of indoor unit.)

2 Every time **UNIT LOUVER** button is pushed, the indoor unit No. in the group control is displayed in order. Select the indoor unit of which setup is changed. In this time, the position of the indoor unit of which setup is changed can be confirmed because fan of the selected indoor unit operate.

3 Specify CODE No. [d1] **TEMP.** buttons.

4 Select **SET DATA** [0001] **TIME** buttons.

SET DATA	8 °C Operation setting
0000	None (Factory default)
0001	8 °C Operation setting

5 Push **SET** button.
In this time, the setup finishes when the display changes from flashing to lighting.

6 Push **TEST** button.(Setup is determined.)
When **TEST** button is pushed, the display disappears and the status becomes the usual stop status. (When **TEST** button is pushed the operation from the remote controller is not accepted for approx. 1 minute.)

10 Test run

■ Before test run

- Before turning on the power supply, carry out the following procedure.
 - 1) By using 500 V-megger, check that resistance of 1 MΩ or more exists between the terminal block 1 to 3 and the earth (grounding).
If resistance of less than 1 MΩ is detected, do not run the unit.
 - 2) Check the valve of the outdoor unit being opened fully.
- To protect the compressor at activation time, leave power-ON for 12 hours or more before operating.

■ Execute a test run

Operate the unit with the wired remote controller as usual.

For the procedure of the operation, refer to the attached Owner's Manual.

A forced test run can be executed in the following procedure even if the operation stops by thermostat-OFF.

In order to prevent a serial operation, the forced test run is released after 60 minutes have passed and returns to the usual operation.

⚠ CAUTION

Do not use the forced test run for cases other than the test run because it applies an excessive load to the devices.

Wired remote controller

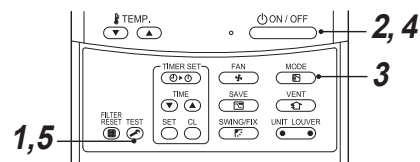

- 1 Push **TEST** button for 4 seconds or more. [TEST] is displayed on the display part and the selection of mode in the test mode is permitted.

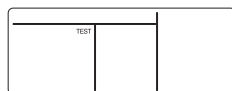

- 2 Push **ON/OFF** button.

- 3 Select the operation mode with **MODE** button.
 - Do not run the air conditioner in a mode other than [Cool] or [Heat].
 - The temperature controlling function does not work during test run.
 - The detection of check code is performed as usual.

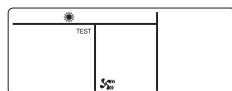

- 4 After the test run, push **ON/OFF** button to stop a test run. (Display part is same as procedure 1.)

- 5 Push **TEST** button to cancel (release from) the test run mode. ([TEST] disappears on the display and the status returns to a normal.)

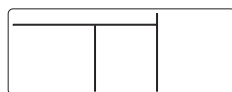

11 Maintenance

⚠ CAUTION

When connecting a return air duct to the unit, the cleaning method of the air filter differs according to the construction of duct end. Ask a qualified installer or qualified service person.

<Daily maintenance> (Once every 3 months)

Cleaning of the air filter (sold separately : TCB-LK2801DP-E)
If **■** is displayed on the remote controller, maintain the air filter.

- 1 Push the **ON/OFF** button to stop the operation, then turn off the circuit breaker.

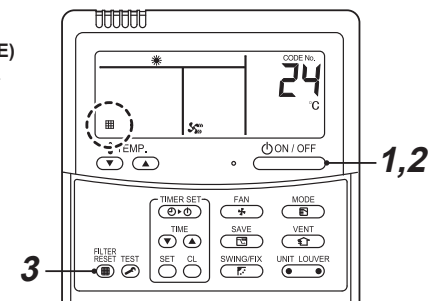

1. Take out the air filter (sold separately).
2. Cleaning with water or vacuum cleaner.
 - If dirt is heavy, clean the air filter by tepid water with neutral detergent or water.
 - After cleaning with water, dry the air filter sufficiently in a shade place.
3. Mount the air filter (sold separately).

- 2 Turn on the circuit breaker, then push the **ON/OFF** button on the remote controller to start the operation.

- 3 After cleaning, push **RESET** button. **■** display disappears.

⚠ CAUTION

- Do not start the air conditioner while leaving air filter (sold separately) removed.
- Push the filter reset button. (■ indication will be turn off.)

▼ **Periodic Maintenance**

For environmental conservation, it is strongly recommended that the indoor and outdoor units of the air conditioner in use be cleaned and maintained regularly to ensure efficient operation of the air conditioner.

When the air conditioner is operated for a long time, periodic maintenance (once a year) is recommended. Furthermore, regularly check the outdoor unit for rust and scratches, and remove them or apply rustproof treatment, if necessary.

As a general rule, when an indoor unit is operated for 8 hours or more daily, clean the indoor unit and outdoor unit at least once every 3 months. Ask a professional for this cleaning / maintenance work.

Such maintenance can extend the life of the product though it involves the owner's expense.

Failure to clean the indoor and outdoor units regularly will result in poor performance, freezing, water leakage, and even compressor failure.

Inspection before maintenance (Once a year)

Following inspection must be carried out by a qualified installer or qualified service person.

Parts	Inspection method
Fan motor	Access from the access panel and check if any abnormal noise can be heard.
Fan	Access from the access panel and remove the access panel. Examine the fan if there are any waggles, damages or adhesive dust.
Filter (sold separately)	Access from check port and check if there are any stains or breaks on the filter.
Drain pan	Access from the access panel and remove the access panel. Check if there is any clogging or drain water is polluted.

- The unit can be accessed from the access panel shown in the figure.

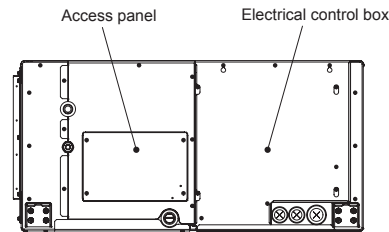

▼ **Maintenance List**

Part	Unit	Check (visual / auditory)	Maintenance
Heat exchanger	Indoor / outdoor	Dust / dirt clogging, scratches	Wash the heat exchanger when it is clogged.
Fan motor	Indoor / outdoor	Sound	Take appropriate measures when abnormal sound is generated.
Filter	Indoor	Dust / dirt, breakage	<ul style="list-style-type: none"> • Wash the filter with water when it is contaminated. • Replace it when it is damaged.
Fan	Indoor	<ul style="list-style-type: none"> • Vibration, balance • Dust / dirt, appearance 	<ul style="list-style-type: none"> • Replace the fan when vibration or balance is terrible. • Brush or wash the fan when it is contaminated.
Air intake / discharge grilles	Indoor / outdoor	Dust / dirt, scratches	Fix or replace them when they are deformed or damaged.
Drain pan	Indoor	Dust / dirt clogging, drain contamination	Clean the drain pan and check the downward slope for smooth drainage.
Ornamental panel, louvers	Indoor	Dust / dirt, scratches	Wash them when they are contaminated or apply repair coating.
Exterior	Outdoor	<ul style="list-style-type: none"> • Rust, peeling of insulator • Peeling / lift of coat 	Apply repair coating.

12 Troubleshooting

■ Confirmation and check

When a problem occurred in the air conditioner, check code and indoor UNIT No. appear on the display part of the remote controller.

The check code is only displayed during the operation. If the display disappears, operate the air conditioner according to the following "Confirmation of check code log" for confirmation.

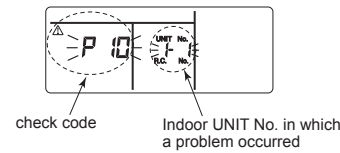

■ Confirmation of check code log

When a problem occurred on the air conditioner, the check code log can be confirmed with the following procedure.

(The check code log is stored in memory up to 4 check code.)

The log can be confirmed from both operating status and stop status.

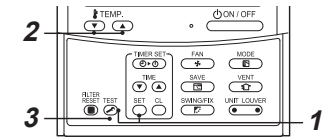

- 1 When **SET** and **TEST** buttons are pushed simultaneously for 4 seconds or more, the following display appears.

If **✓** is displayed, the mode enters in the check code log mode.

- [01: Order of check code log] is displayed in CODE No.
- [Check code] is displayed in CHECK.
- [Indoor unit address in which a problem occurred] is displayed in Unit No..

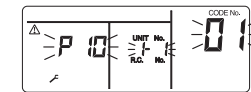

- 2 Every pushing of **TEMP.** button used to set temperature, the check code log stored in memory is displayed in order.

The numbers in CODE No. indicate CODE No. [01] (latest) → [04] (oldest).

REQUIREMENT

Do not push **CL** button because all the check code log of the indoor unit will be deleted.

- 3 After confirmation, push **TEST** button to return to the usual display.

■ Check codes and parts to be checked

Wired remote controller display	Wireless remote controller Sensor block display of receiving unit		Main problem parts	Judging device	Parts to be checked / Check code description	Air conditioner status
	Operation Timer Ready GR GR OR	Flashing				
Indication	Operation Timer Ready GR GR OR	Flashing				
E01	⊙ ● ●		No header remote controller Remote controller regular communication problem	Remote controller	Incorrect remote controller setting --- The header remote controller has not been set (including two remote controllers). No signal can be received from the indoor unit.	*
E02	⊙ ● ●		Remote controller transmission problem	Remote controller	System interconnection wires, indoor p.c. board, remote controller --- No signal can be sent to the indoor unit.	*
E03	⊙ ● ●		Indoor unit-remote controller regular communication problem	Indoor	Remote controller, network adapter, indoor p.c. board --- No data is received from the remote controller or network adapter.	Auto-reset
E04	● ● ⊙		Indoor unit-outdoor unit serial communication problem	Indoor	System interconnection wires, indoor p.c. board, outdoor P.C. board --- Serial communication problem between indoor unit and outdoor unit	Auto-reset
E08	⊙ ● ●		Duplicated indoor addresses ★	Indoor	Indoor address setting problem --- The same address as the self-address was detected.	Auto-reset
E09	⊙ ● ●		Duplicated header remote controllers	Remote controller	Remote controller address setting problem --- Two remote controllers are set as header in the double-remote controller control. (* The header indoor unit stops raising alarm and follower indoor units continue to operate.)	*
E10	⊙ ● ●		Indoor inter-MCU communication problem	Indoor	MCU communication between main controller and motor micro controller have a problem. Communication problem between CDB(MCC-1643) and FAN-IPDU(MCC-1610).	Auto-reset
E18	⊙ ● ●		Header unit follower unit regular communication problem	Indoor	Indoor P.C. board --- Regular communication is not possible between header and follower indoor units or between twin header (main) and follower (sub) units.	Auto-reset
E31	● ● ⊙		IPDU communication problem	Outdoor	Communication problem between IPDU and CDB	Entire stop
F01	⊙ ⊙ ●	ALT	Indoor unit heat exchanger sensor (TCJ) problem	Indoor	Heat exchanger sensor (TCJ), indoor p.c. board --- Open-circuit or short-circuit of the heat exchanger sensor (TCJ) was detected.	Auto-reset
F02	⊙ ⊙ ●	ALT	Indoor unit heat exchanger sensor (TC) problem	Indoor	Heat exchanger sensor (TC), indoor p.c. board --- Open-circuit or short-circuit of the heat exchanger sensor (TC) was detected.	Auto-reset
F04	⊙ ⊙ ○	ALT	Outdoor unit discharge temp, sensor (TD) problem	Outdoor	Outdoor temp, sensor (TD), outdoor p.c. board --- Open-circuit or short-circuit of the discharge temp, sensor was detected.	Entire stop
F06	⊙ ⊙ ○	ALT	Outdoor unit temp, sensor (TE /TS) problem	Outdoor	Outdoor temp, sensors (TE /TS), outdoor p.c. board --- Open-circuit or short-circuit of the heat exchanger temp, sensor was detected.	Entire stop
F07	⊙ ⊙ ○	ALT	TL sensor problem	Outdoor	TL sensor may be displaced, disconnected or short-circuited.	Entire stop
F08	⊙ ⊙ ○	ALT	Outdoor unit outside air temp, sensor problem	Outdoor	Outdoor temp, sensor (TO), outdoor p.c. board --- Open-circuit or short-circuit of the outdoor air temp, sensor was detected.	Operation continued

Wired remote controller display	Wireless remote controller Sensor block display of receiving unit		Main problem parts	Judging device	Parts to be checked / Check code description	Air conditioner status
	Operation Timer Ready GR GR OR	Flashing				
Indication	Operation Timer Ready GR GR OR	Flashing				
F10	⊙ ⊙ ●	ALT	Indoor unit room temp, sensor (TA) problem	Indoor	Room temp, sensor (TA), indoor p.c. board --- Open-circuit or short-circuit of the room temp, sensor (TA) was detected.	Auto-reset
F12	⊙ ⊙ ○	ALT	TS sensor problem	Outdoor	TS sensor may be displaced, disconnected or short-circuited.	Entire-stop
F13	⊙ ⊙ ○	ALT	Heat sink sensor problem	Outdoor	Abnormal temperature was detected by the temp, sensor of the IGBT heat sink.	Entire stop
F15	⊙ ⊙ ○	ALT	Temp, sensor connection problem	Outdoor	Temp, sensor (TE/TS) may be connected incorrectly.	Entire stop
F29	⊙ ⊙ ●	SIM	Indoor unit, other p.c. board problem	Indoor	Indoor P.C. board --- EEPROM problem	Auto-reset
F31	⊙ ⊙ ○	SIM	Outdoor unit p.c. board	Outdoor	Outdoor P.C. board --- In the case of EEPROM problem.	Entire stop
H01	● ⊙ ●		Outdoor unit compressor breakdown	Outdoor	Current detect circuit, power voltage --- Minimum frequency was reached in the current releasing control or short-circuit current (I _{dc}) after direct excitation was detected	Entire stop
H02	● ⊙ ●		Outdoor unit compressor lock	Outdoor	Compressor circuit --- Compressor lock was detected.	Entire stop
H03	● ⊙ ●		Outdoor unit current detect circuit problem	Outdoor	Current detect circuit, outdoor unit p.c. board --- Abnormal current was detected in AC-CT or a phase loss was detected.	Entire stop
H04	● ⊙ ●		Case thermostat operation	Outdoor	Malfunction of the case thermostat	Entire stop
H06	● ⊙ ●		Outdoor unit low-pressure system problem	Outdoor	Current, high-pressure switch circuit, outdoor p.c. board --- Pressure sensor problem was detected or low-pressure protective operation was activated.	Entire stop
L03	⊙ ● ⊙	SIM	Duplicated header indoor units ★	Indoor	Indoor address setting problem --- There are two or more header units in the group.	Entire stop
L07	⊙ ● ⊙	SIM	Group line in individual indoor unit ★	Indoor	Indoor address setting problem --- There is at least one group-connected indoor unit among individual indoor units.	Entire stop
L08	⊙ ● ⊙	SIM	Indoor group address not set ★	Indoor	Indoor address setting problem --- Indoor address group has not been set.	Entire stop
L09	⊙ ● ⊙	SIM	Indoor unit capacity not set	Indoor	Indoor unit capacity has not been set.	Entire stop
L10	⊙ ○ ⊙	SIM	Outdoor unit P.C. board	Outdoor	In the case of outdoor p.c. board jumper wire (for service) setting problem	Entire stop
L20	⊙ ○ ⊙	SIM	LAN communication problem	Network adapter central control	Address setting, central control remote controller, network adapter --- Duplication of address in central control communication	Auto-reset
L29	⊙ ○ ⊙	SIM	Other outdoor unit problem	Outdoor	Other outdoor unit problem 1) Communication problem between IPDU MCU and CDB MCU 2) Abnormal temperature was detected by the heat sink temp, sensor in IGBT.	Entire stop
L30	⊙ ○ ⊙	SIM	Abnormal external input into indoor unit (interlock)	Indoor	External devices, outdoor unit p.c. board --- Abnormal stop due to incorrect external input into CN80	Entire stop

Wired remote controller display	Wireless remote controller Sensor block display of receiving unit		Main problem parts	Judging device	Parts to be checked / Check code description	Air conditioner status
	Operation Timer Ready GR GR OR	Flashing				
L31	⊙ ○ ⊙	SIM	Phase sequence problem, etc.	Outdoor	Power supply phase sequence, outdoor unit p.c. board --- Abnormal phase sequence of the 3-phase power supply	Operation continued (thermost at OFF)
P01	● ⊙ ⊙	ALT	Indoor unit fan problem	Indoor	Indoor fan motor, indoor p.c. board --- Indoor AC fan problem (fan motor thermal relay activated) was detected.	Entire stop
P03	⊙ ● ⊙	ALT	Outdoor unit discharge temp. problem	Outdoor	An problem was detected in the discharge temp. releasing control.	Entire stop
P04	⊙ ● ⊙	ALT	Outdoor unit high-pressure system problem	Outdoor	High-pressure switch --- The IOL was activated or an problem was detected in the high-pressure releasing control using the TE.	Entire stop
P05	⊙ ● ⊙	ALT	Open phase detected	Outdoor	The power wire may be connected incorrectly. Check open phase and voltages of the power supply.	Entire stop
P07	⊙ ● ⊙	ALT	Heat sink overheat	Outdoor	Abnormal temperature was detected by the temp. sensor of the IGBT heat sink.	Entire stop
P10	● ⊙ ⊙	ALT	Indoor unit water overflow detected	Indoor	Drain pipe, clogging of drainage, float switch circuit, indoor P.C. board --- Drainage is out of order or the float switch was activated.	Entire stop
P12	● ⊙ ⊙	ALT	Indoor DC fan problem	Indoor	Indoor DC fan problem (e.g. overcurrent or lock-up) is detected.	Entire stop
P15	⊙ ● ⊙	ALT	Gas leakage detected	Outdoor	There may be gas leakage from the pipe or connecting part. Check for gas leakage.	Entire stop
P19	⊙ ● ⊙	ALT	4-way valve problem	Outdoor (Indoor)	4-way valve, indoor temp. sensors (TC / TCJ) --- An problem was detected due to temperature drop of the indoor unit heat exchanger sensor when heating.	Auto-reset
P20	⊙ ● ⊙	ALT	High-pressure protective operation	Outdoor	High-pressure protection	Entire stop
P22	⊙ ● ⊙	ALT	Outdoor unit fan problem	Outdoor	Outdoor unit fan motor, outdoor unit p.c. board --- An problem (overcurrent, locking, etc.) was detected in the outdoor unit fan drive circuit.	Entire stop
P26	⊙ ● ⊙	ALT	Outdoor unit inverter Idc activated	Outdoor	IGBT, outdoor unit p.c. board, inverter wiring, compressor --- Short-circuit protection for compressor drive circuit devices (G-Tr / IGBT) was activated.	Entire stop
P29	⊙ ● ⊙	ALT	Outdoor unit position problem	Outdoor	Outdoor unit P.C. board, high-pressure switch --- Compressor motor position problem was detected.	Entire stop
P31	⊙ ● ⊙	ALT	Other indoor unit problem	Indoor	Another indoor unit in the group is raising an alarm.	Entire stop
					E03 / L07 / L03 / L08 alarm check locations and problem description	Auto-reset

○ : Lighting ⊙ : Flashing ● : OFF ★ : The air conditioner automatically enters the auto-address setting mode.
 ALT : When two LEDs are flashing, they flash alternately. SIM: When two LEDs are flashing, they flash in synchronization.
 Receiving unit display OR : Orange GR : Green

13 Appendix

Work instructions

The existing R22 and R410A piping can be reused for inverter R32 product installations.

⚠ WARNING

Confirming the existence of scratches or dents on the existing pipes and confirming the reliability of the pipe strength are conventionally referred to the local site.

If the specified conditions can be cleared, it is possible to update existing R22 and R410A pipes to those for R32 models.

Basic conditions needed to reuse existing pipes

Check and observe the presence of three conditions in the refrigerant piping works.

1. **Dry** (There is no moisture inside of the pipes.)
2. **Clean** (There is no dust inside of the pipes.)
3. **Tight** (There are no refrigerant leaks.)

Restrictions for use of existing pipes

In the following cases, the existing pipes should not be reused as they are. Clean the existing pipes or exchange them with new pipes.

1. When a scratch or dent is heavy, be sure to use new pipes for the refrigerant piping works.
2. When the existing pipe thickness is thinner than the specified "Pipe diameter and thickness," be sure to use new pipes for the refrigerant piping works.
 - The operating pressure of refrigerant is high.

If there is a scratch or dent on the pipe or a thinner pipe is used, the pressure strength may be inadequate, which may cause the pipe to break in the worst case.

* Pipe diameter and thickness (mm)

Pipe outer diameter		Ø6.4	Ø9.5	Ø12.7	Ø15.9
Thickness	R32, R410A	0.8	0.8	0.8	1.0
	R22				

3. When the outdoor unit was left with the pipes disconnected, or the gas leaked from the pipes and the pipes were not repaired and refilled.
 - There is the possibility of rain water or air, including moisture, entering the pipe.
4. When refrigerant cannot be recovered using a refrigerant recovery unit.
 - There is the possibility that a large quantity of dirty oil or moisture remains inside the pipes.

5. When a commercially available dryer is attached to the existing pipes.
 - There is the possibility that copper green rust has been generated.
6. When the existing air conditioner is removed after refrigerant has been recovered. Check if the oil is judged to be clearly different from normal oil.
 - The refrigerator oil is copper rust green in color: There is the possibility that moisture has mixed with the oil and rust has been generated inside the pipe.
 - There is discolored oil, a large quantity of residue, or a bad smell.
 - A large quantity of shiny metal dust or other wear residue can be seen in the refrigerant oil.
7. When the air conditioner has a history of the compressor failing and being replaced.
 - When discolored oil, a large quantity of residue, shiny metal dust, or other wear residue or mixture of foreign matter is observed, trouble will occur.
8. When temporary installation and removal of the air conditioner are repeated such as when leased etc.
9. If the type of refrigerator oil of the existing air conditioner is other than the following oil (Mineral oil), Suniso, Freol-S, MS (Synthetic oil), alkyl benzene (HAB, Barrel-freeze), ester series, PVE only of ether series.
 - The winding-insulation of the compressor may deteriorate.

NOTE

The above descriptions are results have been confirmed by our company and represent our views on our air conditioners, but do not guarantee the use of the existing pipes of air conditioners that have adopted R32, R410A in other companies.

Curing of pipes

When removing and opening the indoor or outdoor unit for a long time, cure the pipes as follows:

- Otherwise rust may be generated when moisture or foreign matter due to condensation enters the pipes.
- The rust cannot be removed by cleaning, and new pipes are necessary.

Placement location	Term	Curing manner
Outdoors	1 month or more	Pinching
	Less than 1 month	
Indoors	Every time	Pinching or taping

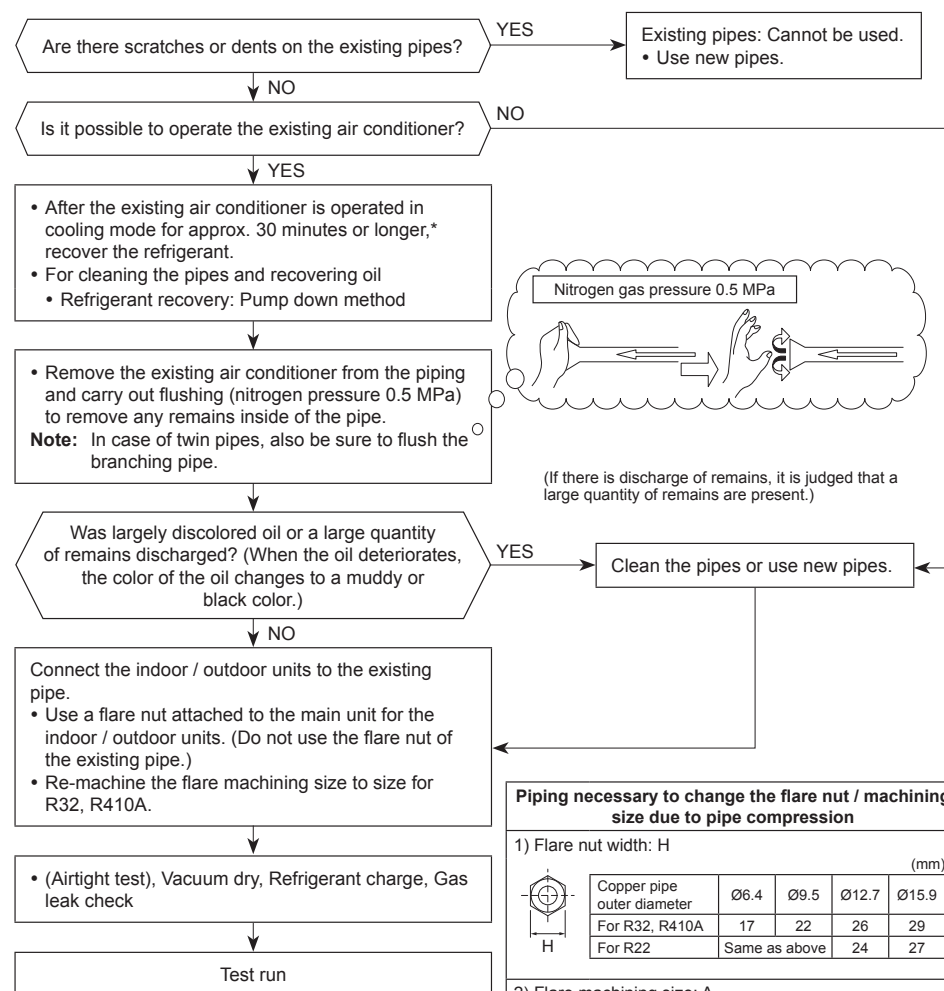

Piping necessary to change the flare nut / machining size due to pipe compression

1) Flare nut width: H (mm)

Copper pipe outer diameter	Ø6.4	Ø9.5	Ø12.7	Ø15.9
For R32, R410A	17	22	26	29
For R22	Same as above	24	27	

2) Flare machining size: A (mm)

Copper pipe outer diameter	Ø6.4	Ø9.5	Ø12.7	Ø15.9
For R32, R410A	9.1	13.2	16.6	19.7
For R22	9.0	13.0	16.2	19.4

Becomes a little larger for R32, R410A

Do not apply refrigerator oil to the flare surface.

TOSHIBA CARRIER (THAILAND) CO.,LTD.

144 / 9 Moo 5, Bangkadi Industrial Park, Tivanon Road, Tambol Bangkadi, Amphur Muang, Pathumthani 12000, Thailand

1116950192