

TOSHIBA

Leading Innovation >>>

AIR CONDITIONER (MULTI TYPE)

Installation Manual



Indoor Unit

Model name: _____

For commercial use

Concealed Duct Type Fresh Air Intake Unit

MMD-AP0481HFE

MMD-AP0721HFE

MMD-AP0961HFE

Original instruction

- Please read this Installation Manual carefully before installing the Air Conditioner.
- This Manual describes the installation method of the indoor unit.
 - For installation of the outdoor unit, follow the Installation Manual attached to the outdoor unit.

ADOPTION OF NEW REFRIGERANT

This Air Conditioner uses R410A an environmentally friendly refrigerant.

Contents

1	Precautions for safety	3
2	Accessory parts	5
3	System control of fresh air intake unit.	5
4	Selection of installation place.	6
5	Installation	7
6	Duct work	8
7	Fan characteristics.	10
8	Drain piping	12
9	Refrigerant piping	13
10	Electrical connection	14
11	Applicable controls	16
12	Test run	17
13	Maintenance	18
14	Troubleshooting	19

Thank you for purchasing this Toshiba air conditioner. Please read carefully through these instructions that contain important information which complies with the "Machinery" Directive (Directive 2006/42/EC), and ensure that you understand them. After completing the installation work, hand over this Installation Manual as well as the Owner's Manual attached to the outdoor unit provided with the outdoor unit to the user, and ask the user to keep them in a safe place for future reference.

Generic Denomination: Air Conditioner

Definition of Qualified Installer or Qualified Service Person

The air conditioner must be installed, maintained, repaired and removed by a qualified installer or qualified service person. When any of these jobs is to be done, ask a qualified installer or qualified service person to do them for you. A qualified installer or qualified service person is an agent who has the qualifications and knowledge described in the table below.

Agent	Qualifications and knowledge which the agent must have
Qualified installer	<ul style="list-style-type: none"> • The qualified installer is a person who installs, maintains, relocates and removes the air conditioners made by Toshiba Carrier Corporation. He or she has been trained to install, maintain, relocate and remove the air conditioners made by Toshiba Carrier Corporation or, alternatively, he or she has been instructed in such operations by an individual or individuals who have been trained and is thus thoroughly acquainted with the knowledge related to these operations. • The qualified installer who is allowed to do the electrical work involved in installation, relocation and removal has the qualifications pertaining to this electrical work as stipulated by the local laws and regulations, and he or she is a person who has been trained in matters relating to electrical work on the air conditioners made by Toshiba Carrier Corporation or, alternatively, he or she has been instructed in such matters by an individual or individuals who have been trained and is thus thoroughly acquainted with the knowledge related to this work. • The qualified installer who is allowed to do the refrigerant handling and piping work involved in installation, relocation and removal has the qualifications pertaining to this refrigerant handling and piping work as stipulated by the local laws and regulations, and he or she is a person who has been trained in matters relating to refrigerant handling and piping work on the air conditioners made by Toshiba Carrier Corporation or, alternatively, he or she has been instructed in such matters by an individual or individuals who have been trained and is thus thoroughly acquainted with the knowledge related to this work. • The qualified installer who is allowed to work at heights has been trained in matters relating to working at heights with the air conditioners made by Toshiba Carrier Corporation or, alternatively, he or she has been instructed in such matters by an individual or individuals who have been trained and is thus thoroughly acquainted with the knowledge related to this work.
Qualified service person	<ul style="list-style-type: none"> • The qualified service person is a person who installs, repairs, maintains, relocates and removes the air conditioners made by Toshiba Carrier Corporation. He or she has been trained to install, repair, maintain, relocate and remove the air conditioners made by Toshiba Carrier Corporation or, alternatively, he or she has been instructed in such operations by an individual or individuals who have been trained and is thus thoroughly acquainted with the knowledge related to these operations. • The qualified service person who is allowed to do the electrical work involved in installation, repair, relocation and removal has the qualifications pertaining to this electrical work as stipulated by the local laws and regulations, and he or she is a person who has been trained in matters relating to electrical work on the air conditioners made by Toshiba Carrier Corporation or, alternatively, he or she has been instructed in such matters by an individual or individuals who have been trained and is thus thoroughly acquainted with the knowledge related to this work. • The qualified service person who is allowed to do the refrigerant handling and piping work involved in installation, repair, relocation and removal has the qualifications pertaining to this refrigerant handling and piping work as stipulated by the local laws and regulations, and he or she is a person who has been trained in matters relating to refrigerant handling and piping work on the air conditioners made by Toshiba Carrier Corporation or, alternatively, he or she has been instructed in such matters by an individual or individuals who have been trained and is thus thoroughly acquainted with the knowledge related to this work. • The qualified service person who is allowed to work at heights has been trained in matters relating to working at heights with the air conditioners made by Toshiba Carrier Corporation or, alternatively, he or she has been instructed in such matters by an individual or individuals who have been trained and is thus thoroughly acquainted with the knowledge related to this work.

Definition of Protective Gear





When the air conditioner is to be transported, installed, maintained, repaired or removed, wear protective gloves and 'safety' work clothing.

In addition to such normal protective gear, wear the protective gear described below when undertaking the special work detailed in the table below.

Failure to wear the proper protective gear is dangerous because you will be more susceptible to injury, burns, electric shocks and other injuries.

Work undertaken	Protective gear worn
All types of work	Protective gloves 'Safety' working clothing
Electrical-related work	Gloves to provide protection for electricians and from heat Insulating shoes Clothing to provide protection from electric shock
Work done at heights (50 cm or more)	Helmets for use in industry
Transportation of heavy objects	Shoes with additional protective toe cap
Repair of outdoor unit	Gloves to provide protection for electricians and from heat

■ Warning indications on the air conditioner unit

Warning indication	Description		
 <table border="1"> <tr> <td>WARNING</td> </tr> <tr> <td>ELECTRICAL SHOCK HAZARD Disconnect all remote electric power supplies before servicing.</td> </tr> </table>	WARNING	ELECTRICAL SHOCK HAZARD Disconnect all remote electric power supplies before servicing.	<p>WARNING</p> <p>ELECTRICAL SHOCK HAZARD Disconnect all remote electric power supplies before servicing.</p>
WARNING			
ELECTRICAL SHOCK HAZARD Disconnect all remote electric power supplies before servicing.			
 <table border="1"> <tr> <td>WARNING</td> </tr> <tr> <td>Moving parts. Do not operate unit with grille removed. Stop the unit before the servicing.</td> </tr> </table>	WARNING	Moving parts. Do not operate unit with grille removed. Stop the unit before the servicing.	<p>WARNING</p> <p>Moving parts. Do not operate unit with grille removed. Stop the unit before the servicing.</p>
WARNING			
Moving parts. Do not operate unit with grille removed. Stop the unit before the servicing.			
 <table border="1"> <tr> <td>CAUTION</td> </tr> <tr> <td>High temperature parts. You might get burned when removing this panel.</td> </tr> </table>	CAUTION	High temperature parts. You might get burned when removing this panel.	<p>CAUTION</p> <p>High temperature parts. You might get burned when removing this panel.</p>
CAUTION			
High temperature parts. You might get burned when removing this panel.			
 <table border="1"> <tr> <td>CAUTION</td> </tr> <tr> <td>Do not touch the aluminum fins of the unit. Doing so may result in injury.</td> </tr> </table>	CAUTION	Do not touch the aluminum fins of the unit. Doing so may result in injury.	<p>CAUTION</p> <p>Do not touch the aluminium fins of the unit. Doing so may result in injury.</p>
CAUTION			
Do not touch the aluminum fins of the unit. Doing so may result in injury.			
 <table border="1"> <tr> <td>CAUTION</td> </tr> <tr> <td>BURST HAZARD Open the service valves before the operation, otherwise there might be the burst.</td> </tr> </table>	CAUTION	BURST HAZARD Open the service valves before the operation, otherwise there might be the burst.	<p>CAUTION</p> <p>BURST HAZARD Open the service valves before the operation, otherwise there might be the burst.</p>
CAUTION			
BURST HAZARD Open the service valves before the operation, otherwise there might be the burst.			

1 Precautions for safety

The manufacturer shall not assume any liability for the damage caused by not observing the description of this manual.

WARNING

General

- Before starting to install the air conditioner, read through the Installation Manual carefully, and follow its instructions to install the air conditioner.
- Only a qualified installer or service person is allowed to do installation work. Inappropriate installation may result in water leakage, electric shock or fire.
- Do not use any refrigerant different from the one specified for complement or replacement. Otherwise, abnormally high pressure may be generated in the refrigeration cycle, which may result in a failure or explosion of the product or an injury to your body.
- Before opening the intake grille of the indoor unit or service panel of the outdoor unit, set the circuit breaker to the OFF position. Failure to set the circuit breaker to the OFF position may result in electric shocks through contact with the interior parts. Only a qualified installer(*1) or qualified service person(*1) is allowed to remove the intake grille of the indoor unit or service panel of the outdoor unit and do the work required.
- Before carrying out the installation, maintenance, repair or removal work, set the circuit breaker to the OFF position. Otherwise, electric shocks may result.
- Place a "Work in progress" sign near the circuit breaker while the installation, maintenance, repair or removal work is being carried out. There is a danger of electric shocks if the circuit breaker is set to ON by mistake.
- Only a qualified installer(*1) or qualified service person(*1) is allowed to undertake work at heights using a stand of 50 cm or more or to remove the intake grille of the indoor unit to undertake work.
- Wear protective gloves and safety work clothing during installation, servicing and removal.
- Do not touch the aluminium fin of the unit. You may injure yourself if you do so. If the fin must be touched for some reason, first put on protective gloves and safety work clothing, and then proceed.
- Do not climb onto or place objects on top of the outdoor unit. You may fall or the objects may fall off of the outdoor unit and result in injury.
- When work is performed at heights, use a ladder which complies with the ISO 14122 standard, and follow the procedure in the ladder's instructions. Also wear a helmet for use in industry as protective gear to undertake the work.
- Before cleaning the filter or other parts of the outdoor unit, set the circuit breaker to OFF without fail, and place a "Work in progress" sign near the circuit breaker before proceeding with the work.
- Before working at heights, put a sign in place so that no-one will approach the work location, before proceeding with the work. Parts and other objects may fall from above, possibly injuring a person below. While carrying out the work, wear a helmet for protection from falling objects.
- The refrigerant used by this air conditioner is the R410A.
- The air conditioner must be transported in stable condition. If any part of the product is broken, contact the dealer.
- When the air conditioner must be transported by hand, carry it by two or more people.
- Do not move or repair any unit by yourself. There is high voltage inside the unit. You may get electric shock when removing the cover and main unit.

Selection of installation location

- When the air conditioner is installed in a small room, provide appropriate measures to ensure that the concentration of refrigerant leakage occur in the room does not exceed the critical level.
- Do not install in a location where flammable gas leaks are possible. If the gas leak and accumulate around the unit, it may ignite and cause a fire.
- To transport the air conditioner, wear shoes with additional protective toe caps.
- To transport the air conditioner, do not take hold of the bands around the packing carton. You may injure yourself if the bands should break.
- Install the indoor unit at least 2.5 m above the floor level since otherwise the users may injure themselves or receive electric shocks if they poke their fingers or other objects into the indoor unit while the air conditioner is running.
- Do not place any combustion appliance in a place where it is directly exposed to the wind of air conditioner, otherwise it may cause imperfect combustion.

Installation

- Suction duct length must be longer than 850 mm.
- When the indoor unit is to be suspended, the designated hanging bolts (M10 or W3/8) and nuts (M10 or W3/8) must be used.
- Install the air conditioner securely in a location where the base can sustain the weight adequately. If the strength is not enough, the unit may fall down resulting in injury.
- Follow the instructions in the Installation Manual to install the air conditioner. Failure to follow these instructions may cause the product to fall down or topple over or give rise to noise, vibration, water leakage or other trouble.
- Carry out the specified installation work to guard against the possibility of high winds and earthquake. If the air conditioner is not installed appropriately, a unit may topple over or fall down, causing an accident.
- If refrigerant gas has leaked during the installation work, ventilate the room immediately. If the leaked refrigerant gas comes in contact with fire, noxious gas may generate.
- Use forklift to carry in the air conditioner units and use winch or hoist at installation of them.
- Helmet must be worn to protect your head from falling objects. Especially, when you work under an inspection opening, helmet must be worn to protect your head from falling objects from the opening.
- The unit can be accessed from the service panel.

Refrigerant piping

- Install the refrigerant pipe securely during the installation work before operating the air conditioner. If the compressor is operated with the valve open and without refrigerant pipe, the compressor sucks air and the refrigeration cycles is over pressurized, which may cause a injury.
- Tighten the flare nut with a torque wrench in the specified manner. Excessive tighten of the flare nut may cause a crack in the flare nut after a long period, which may result in refrigerant leakage.
- After the installation work, confirm that refrigerant gas does not leak. If refrigerant gas leaks into the room and flows near a fire source, such as a cooking range, noxious gas may be generated.
- When the air conditioner has been installed or relocated, follow the instructions in the Installation Manual and purge the air completely so that no gases other than the refrigerant will be mixed in the refrigerating cycle. Failure to purge the air completely may cause the air conditioner to malfunction.
- Nitrogen gas must be used for the airtight test.
- The charge hose must be connected in such a way that it is not slack.

Electrical wiring

- Only a qualified installer(*1) or qualified service person(*1) is allowed to carry out the electrical work of the air conditioner. Under no circumstances must this work be done by an unqualified individual since failure to carry out the work properly may result in electric shocks and / or electrical leaks.
- To connect the electrical wires, repair the electrical parts or undertake other electrical jobs, wear gloves to provide protection for electricians and from heat, insulating shoes and clothing to provide protection from electric shocks. Failure to wear this protective gear may result in electric shocks.
- Use wiring that meets the specifications in the Installation Manual and the stipulations in the local regulations and laws. Use of wiring which does not meet the specifications may give rise to electric shocks, electrical leakage, smoking and / or a fire.
- Connect earth wire. (Grounding work)
Incomplete grounding causes an electric shock.
- Do not connect earth wires to gas pipes, water pipes, and lightning conductor or telephone earth wires.
- After completing the repair or relocation work, check that the earth wires are connected properly.
- Install a circuit breaker that meets the specifications in the installation manual and the stipulations in the local regulations and laws.
- Install the circuit breaker where it can be easily accessed by the agent.
- When installing the circuit breaker outdoors, install one which is designed to be used outdoors.
- Under no circumstances the power wire must not be extended. Connection trouble in the places where the wire is extended may give rise to smoking and / or a fire.
- Electrical wiring work shall be conducted according to law and regulation in the community and installation manual. Failure to do so may result in electrocution or short circuit.

Test run

- Before operating the air conditioner after having completed the work, check that the electrical parts box cover of the indoor unit and service panel of the outdoor unit are closed, and set the circuit breaker to the ON position. You may receive an electric shock if the power is turned on without first conducting these checks.
- If there is any kind of trouble (such as an error display has appeared, smell of burning, abnormal sounds, the air conditioner fails to cool or heat or water is leaking) has occurred in the air conditioner, do not touch the air conditioner yourself but set the circuit breaker to the OFF position, and contact a qualified service person. Take steps to ensure that the power will not be turned on (by marking "out of service" near the circuit breaker, for instance) until qualified service person arrives. Continuing to use the air conditioner in the trouble status may cause mechanical problems to escalate or result in electric shocks or other trouble.
- After the work has finished, use an insulation tester set (500 V Megger) to check the resistance is 1 MΩ or more between the charge section and the non-charge metal section (Earth section). If the resistance value is low, a disaster such as a leak or electric shock is caused at user's side.
- Upon completion of the installation work, check for refrigerant leaks and check the insulation resistance and water drainage. Then conduct a test run to check that the air conditioner is operating properly.

Explanations given to user

- Upon completion of the installation work, tell the user where the circuit breaker is located. If the user does not know where the circuit breaker is, he or she will not be able to turn it off in the event that trouble has occurred in the air conditioner.
- If the fan grille is damaged, do not approach the outdoor unit but set the circuit breaker to the OFF position, and contact a qualified service person(*1) to have the repairs done. Do not set the circuit breaker to the ON position until the repairs are completed.

Relocation

- Only a qualified installer(*1) or qualified service person(*1) is allowed to relocate the air conditioner. It is dangerous for the air conditioner to be relocated by an unqualified individual since a fire, electric shocks, injury, water leakage, noise and / or vibration may result.
 - When carrying out the pump-down work shut down the compressor before disconnecting the refrigerant pipe. Disconnecting the refrigerant pipe with the service valve left open and the compressor still operating will cause air or other gas to be sucked in, raising the pressure inside the refrigeration cycle to an abnormally high level, and possibly resulting in rupture, injury or other trouble.
-

CAUTION

New Refrigerant Air Conditioner Installation

- **THIS AIR CONDITIONER ADOPTS THE NEW HFC REFRIGERANT (R410A) WHICH DOES NOT DESTROY OZONE LAYER.**
 - The characteristics of R410A refrigerant are; easy to absorb water, oxidizing membrane or oil, and its pressure is approx. 1.6 times higher than that of refrigerant R22. Accompanied with the new refrigerant, refrigerating oil has also been changed. Therefore, do not let water, dust, former refrigerant, or refrigerating oil enter the refrigerating cycle during installation work.
 - To prevent charging an incorrect refrigerant and refrigerating oil, the sizes of connecting sections of charging port of the main unit and installation tools are changed from those for the conventional refrigerant.
 - Accordingly the exclusive tools are required for the new refrigerant (R410A).
 - For connecting pipes, use new and clean piping designed for R410A, and please care so that water or dust does not enter.



To Disconnect the Appliance from Main Power Supply.

- This appliance must be connected to the main power supply by means of a switch with a contact separation of at least 3 mm.

The installation fuse (all types can be used) must be used for the power supply line of this conditioner.

(*1) Refer to the "Definition of Qualified Installer or Qualified Service Person."

2 Accessory parts

Part name	Q'ty	Shape	Usage
Owner's Manual	1	—	(Be sure to hand over to customers)
Installation Manual	1	This manual	(Be sure to hand over to customers)
CD-ROM	1	—	Installation Manual
Heat insulator	1		For heat insulation of Gas pipe connecting section
	1		For heat insulation of Liquid pipe connecting section
	4		For heat insulation of hanging bracket

NOTE

The wired remote controller must be connected. Settings cannot be made for systems without remote controls.

3 System control of fresh air intake unit

■ System able to be combined

The fresh air intake unit is connectable to SMMS (Super Modular Multi system). However this is not connectable to SHRM (Super Heat Recovery Multi system).

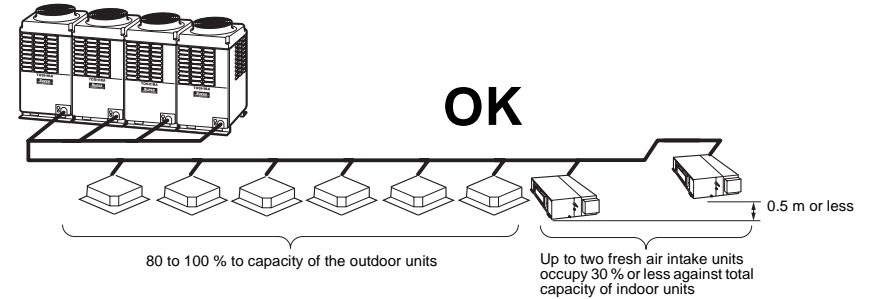

Keep the height difference between the fresh air intake units to 0.5 m or less.

- The fresh air intake unit is usually used together with the indoor units on one line of the multi system. The fresh air intake unit only cannot be connected.

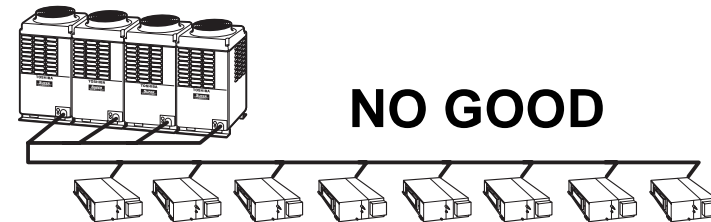

- The total capacity of the indoor units and the fresh air intake units is restricted to 80 % to 100 % against the capacity of the outdoor units. (This restriction should be strictly kept for correct control of the refrigerant.)
- Up to two fresh air intake units can be connected on one line of the multi system. The allowable total capacity of the two fresh air intake units shall be 30 % or less against the total capacity of the indoor units (including the fresh air intake units).

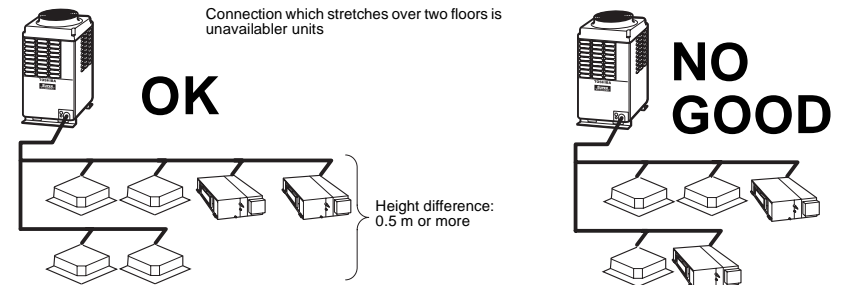

4 Selection of installation place

Avoid installing in the following places.

Select a location for the indoor unit where the cool or warm air will circulate evenly.

Avoid installation in the following kinds of locations.

- Locations where inside the ceiling is used as route for fresh air.
- Saline area (coastal area)
- Locations with acidic or alkaline atmospheres (such as areas with hot springs, factories where chemicals or pharmaceuticals are made and places where the exhaust air from combustion appliances will be sucked into the unit).
Doing so may cause the heat exchanger (its aluminum fins and copper pipes) and other parts to become corroded.
- Locations with atmospheres with mist of cutting oil or other types of machine oil.
Doing so may cause the heat exchanger to become corroded, mists caused by the blockage of the heat exchanger to be generated, the plastic parts to be damaged, the heat insulators to peel off, and other such problems to result.
- Places where iron or other metal dust is present. If iron or other metal dust adheres to or collects on the interior of the air conditioner, it may spontaneously combust and start a fire.
- Locations where vapors from food oils are formed (such as kitchens where food oils are used).
Blocked filters may cause the air conditioner's performance to deteriorate, condensation to form, the plastic parts to be damaged, and other such problems to result.
- Locations near obstructions such as ventilation openings or lighting fixtures where the flow of the blown air will be disrupted (a disruption of the air flow may cause the air conditioner's performance to deteriorate or the unit to shut down).
- Locations where an in-house power generator is used for the power supply.
The power line frequency and voltage may fluctuate, and the air conditioner may not work properly as a result.
- On truck cranes, ships or other moving conveyances.
- The air conditioner must not be used for special applications (such as for storing food, plants, precision instruments or art works).
(The quality of the items stored may be degraded.)
- Locations where high frequencies are generated (by inverter equipment, in-house power generators, medical equipment or communication equipment).
(Malfunctioning or control trouble in the air conditioner or noise may adversely affect the equipment's operation.)
- Locations where there is anything under the unit installed that would be compromised by wetness.
(If the drain has become blocked or when the humidity is over 80 %, condensation from the indoor unit will drip, possibly causing damage to anything underneath.)
- Locations where organic solvents are being used.
- The air conditioner cannot be used for liquefied carbonic acid cooling or in chemical plants.
- Location near doors or windows where the air conditioner may come into contact with high-temperature, high-humidity outdoor air.
(Condensation may occur as a result.)
- Locations where special sprays are used frequently.

Installation space

Keep the space necessary for installation and service.

REQUIREMENT

1. Before installation of the unit, mount the accessories sold separately (Drain-up kit, etc.) to the unit.
In addition to the air intake panel, set also the check port at the side face.
2. The check port should be 600 × 600 mm.

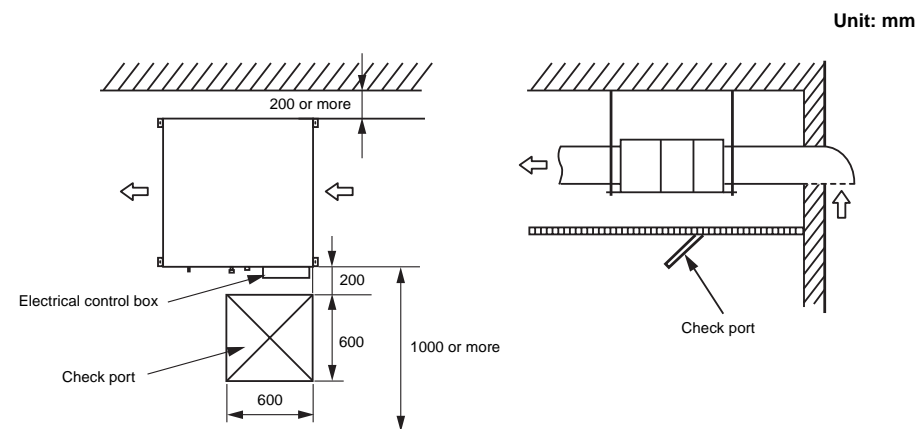

Installation under atmosphere of the high humidity

Although it has been confirmed that no trouble occurs on the unit, there is a fear of drip of the water if operation under high humidity condition continues.

In some cases including the rainy season, especially inside of the ceiling may become high-humidity atmosphere (dew-point temperature: 30 °C (humidity: 80 %) or higher).

1 Installation to inside of the ceiling with tiles on the roof.

2 Installation to inside of the ceiling with slated roof.

3 Installation to inside of the ceiling with kitchen.

- In the above cases, additionally attach the heat insulator (Glass wool, etc.) to all positions of the air conditioner, which come to contact with the high-humidity atmosphere.
In this case, arrange the side plate (Service panel) so that it is easily removed.
- Apply also heat insulating a sufficient thickness 10 mm or more to the duct and connecting part of the duct.

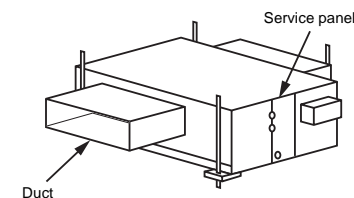

5 Installation

WARNING

Install the air conditioner certainly to sufficiently withstand the weight.
If the strength is insufficient, the unit may fall down resulting in human injury.
Perform a specified installation work to guard against strong wind or earthquake.
An incomplete installation can cause accidents by the units falling and dropping.

REQUIREMENT

- Strictly comply with the following rules to prevent damage of the indoor units and human injury.
- Do not put a heavy article on the indoor unit. (Even units are packaged)
 - Carry in the indoor unit as it is packaged if possible.
If carrying in the indoor unit unpacked by necessity, be sure to use buffering cloth, etc. to not damage the unit.
 - To move the indoor unit, hold the hooking metals (4 positions) only.
Do not apply force to the other parts (refrigerant pipe, drain pan, foamed parts, or resin parts, etc.).
 - Carry the package by two or more persons, and do not bundle it with PP band at positions other than specified.
 - Use a forklift to transport materials. Do not drag or push the package because it is made of cardboard.
 - If the vibration insulator is applied to the hanging bolt, make sure it does not cause larger vibration in the main unit before using it.

External view

Installing the four 10 mm-diameter hanging bolts

- Space the hanging bolts according to the dimensions shown in the diagrams below.
- Use 10 mm-diameter hanging bolts (Required at the site).

Unit: mm

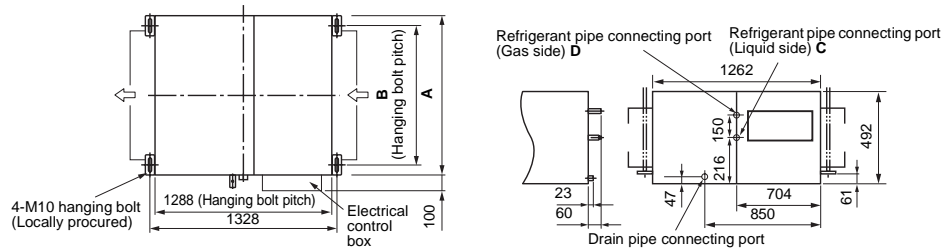

Model MMD-	A	B	C	D
AP048*	892	810	Ø9.5 flare	Ø15.9 flare
AP072* AP096*	1392	1260	Ø12.7 flare	Ø22.2 brazing

Considering piping and wire connecting works in the ceiling after hanging down the indoor unit, select an installation place and then determine the drawing-out direction of the pipes.

- If the ceiling has been already set, draw the refrigerant pipe, drain pipe, inter-unit wire between indoor and outdoor units, central control system wire and remote controller cord up to the positions where pipes and wires are connected before hanging down the indoor unit.

Treatment of ceiling

The ceiling differs according to structure of building.
For details, consult your constructor or interior finish contractor.

In the process after the ceiling board has been removed, it is important to reinforce ceiling foundation (frame) and to keep horizontal level of installed ceiling correctly in order to prevent vibration of ceiling board.

Installation of hanging bolt

Use M10 hanging bolts (4 pcs, locally procured).

Matching to the existing structure, set pitch according to size in the unit external view as shown below.

New concrete slab	Steel frame structure	Existing concrete slab
Install the bolts with insert brackets or anchor bolts. (Blade type bracket) (Slide type bracket) (Pipe hanging anchor bolt)	Use existing angles or install new support angles. Hanging bolt, Hanging bolt, Support angle	Use a hole-in anchors, hole-in plugs, or a hole-in bolts.

Hanging up of unit

- Adjust the nut position (lower side).
- Hang up the main unit by hanging nut of hanging bolt to T groove of hanging bracket of the indoor unit.
- Using the level vial, etc., check that four sides are horizontal. (Horizontal degree: within 5 mm)
- Attach canvas ducts (locally procured) to the air intake and the air discharge so that vibration of the main unit does not travel to the duct or ceiling. Attach also acoustic-absorption material to the inner liner of the duct and the vibration-proof rubber to the hanging bolt.

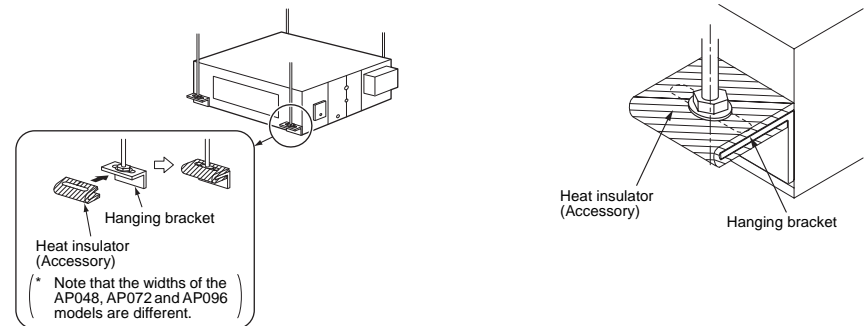

REQUIREMENT

- Using a level vial, etc., confirm the horizontal level of the indoor unit.
- Tighten the nut sufficiently, and fix it securely.

■ Installation of indoor unit

1 Install temporarily the indoor unit.

Attach the hanging bracket to the hanging bolt.

Be sure to fix the hanging bracket from both up and down sides of the hanging bracket by using the nuts (M10 locally procured) and the washer.

2 Using nut, adjust height of the main unit.

3 Check the main unit is horizontally installed.

Attach canvas ducts (locally procured) to the air intake and the air discharge so that vibration of the main unit does not travel to the duct or ceiling.

Attach also acoustic-absorption material to the inner liner of the duct and the vibration-proof rubber to the hanging bolt.

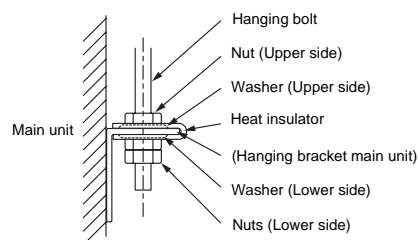

REQUIREMENT

Make sure that the unit is hanging level.

If it is hung horizontally, the drain pan may overflow. Install the unit within the dimensions indicated below.

Front view

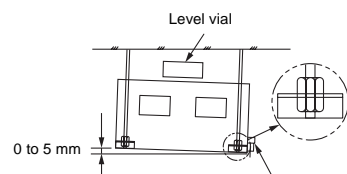

Install the main unit within 5 mm while lowering the drain pipe connecting port side slightly.

Side view

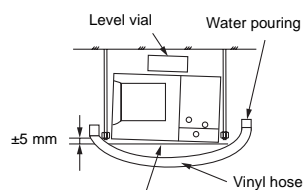

Install both air intake and air supply port sides within ± 5 mm.

Using a level vial or vinyl hose, check whether the indoor unit is hung horizontally or not.

6 Duct work

⚠ CAUTION

Be sure to apply heat insulation to the duct to prevent dewy condition.

If there is an incomplete duct work, the water leakage into the room may happen.

REQUIREMENT

- In order to prevent short circuits, design the duct work so that the intake and discharge openings are not adjacent to each other.
- Install the filter chamber on the intake side of the indoor unit. Attach the long life prefilter and high-efficiency filter to the filter chamber to remove dust. Send fresh air to the inside of the indoor unit and the area being air conditioned.
- If no air filter is installed, dust will collect in the heat exchanger, which may cause the air conditioner to fail or to leak.
- Be sure to set the duct at air intake side with descending inclination because the suction duct of the this unit is exposed to outdoors and therefore rainwater, leaves and birds are easy to enter in if it is set horizontally. Attaching wire netting and others to end of the suction duct is also recommended.
- Connect the duct so that the air intake sucks fresh air only. Be sure to apply heat insulation for the duct to prevent dewing. (Recommended material: Glass wool or foam polyethylene, Thickness: 25 mm)
- When welding the duct at the site, sparks may enter in the air filter or heat insulator. To avoid spread of the fire, cover the duct with iron plate, etc.
- When penetrating metal lath, wire lath or metal plank with the metal duct, isolate the duct from the wall electrically.
- Set the canvas ducts at air intake port and air supply port. It is to avoid conveyance of vibration, abnormal resonance sound and also to make easy the disassembly of the main unit in service time.
- Connect the ducts so that the ducts do not weight on the main unit. If connecting the ducts directly to the main unit, the duct vibration abnormal sound from the main unit may happen, and also the filter and service panel cannot be detached.
- Be sure to fix the ducts by using the hanging bolts.

■ Duct work

After installing the product, perform the duct work according to the working diagram.

■ Connecting flange

Refer to size in the figure attached to the main unit.

<MMD-AP048 type>

<Air supply port connecting flange>

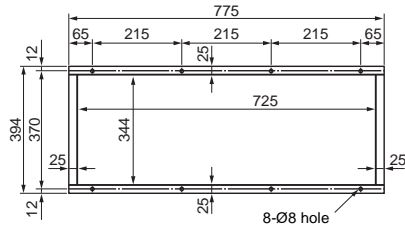

<Air intake port connecting flange>

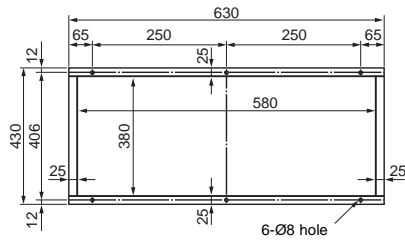

<MMD-AP072 type, AP096 type>

<Air supply port connecting flange>

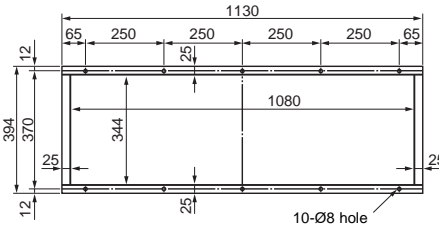

<Air intake port connecting flange>

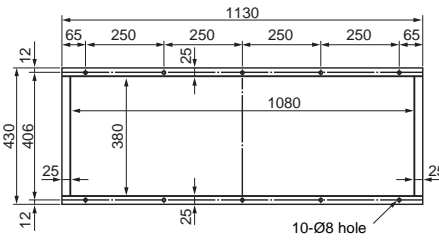

REQUIREMENT

If the air conditioner unit and the canvas joint are connected with the rivets, the fan and the refrigerating cycle cannot be checked.

Be sure to use the flange as shown in the above and tighten it by the bolts.
(Fixing bolts M6 x 12 mm, locally procured)

<Example of construction>

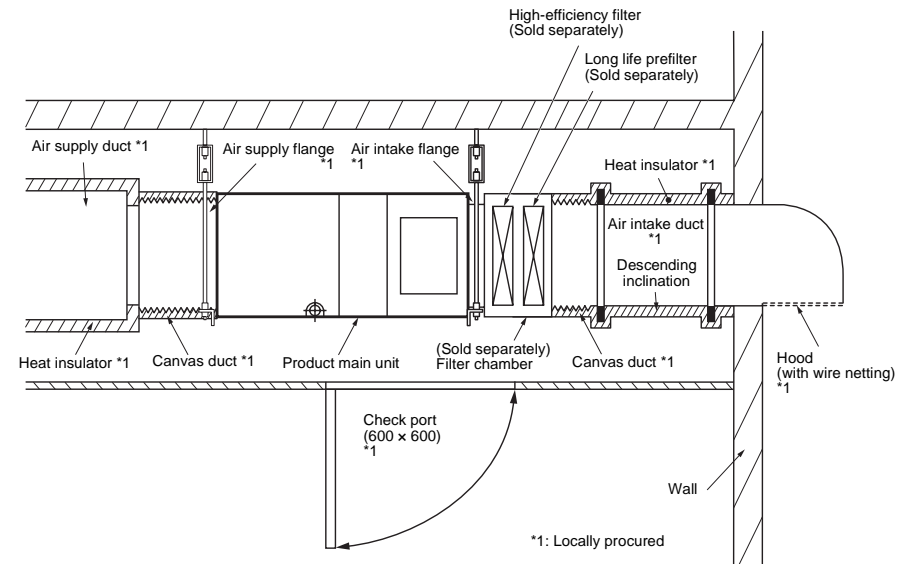

1 Air intake duct

- Connect the air intake duct (Locally procured) to the inlet flange.
Wrap aluminum tape around connecting part between the air intake port flange and duct, or provide sealer so that air does not leak.
- For the fresh air intake port, attach a hood so that fresh air is sucked from lower side.
And attach wire netting, etc. to the air intake of the hood.
- Set the air intake duct at descending inclination so that water can be drained even if rainwater enters in.
- Wrap the outside of the intake duct with heat insulator because it intakes cold air while heating.

2 Air supply duct

Connect the air supply duct (Locally procured) to the Air supply flange.
Wrap aluminum tape around connecting part of the air supply port flange and duct or apply packing so that air does not leak.

7 Fan characteristics

Fan characteristics

<MMD-AP048 type>

(Standard air volume: 1080 m³/h, Lower limit air volume: 756 m³/h, Upper limit air volume: 1188 m³/h)

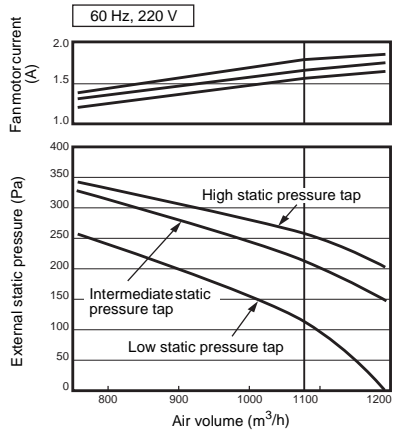
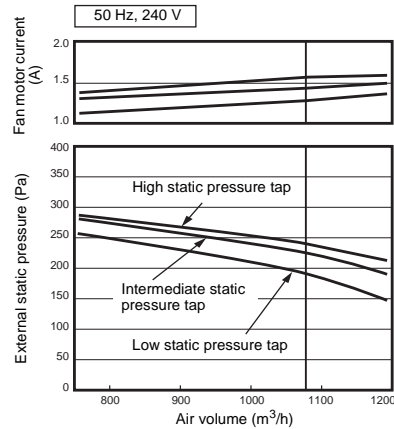
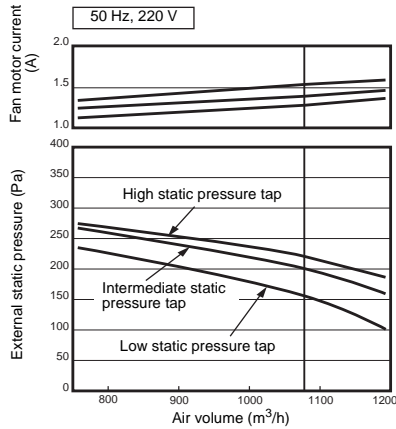

REQUIREMENT

Set a volume damper to the air supply duct, and then adjust the air volume so that it is kept in the range of 70 to 110 % against the standard air volume.

<MMD-AP072 type>

(Standard air volume: 1680 m³/h, Lower limit air volume: 1176 m³/h, Upper limit air volume: 1848 m³/h)

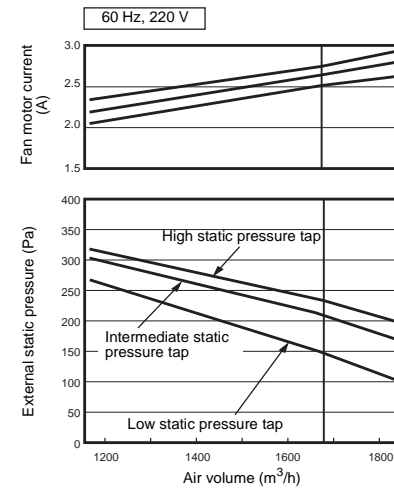
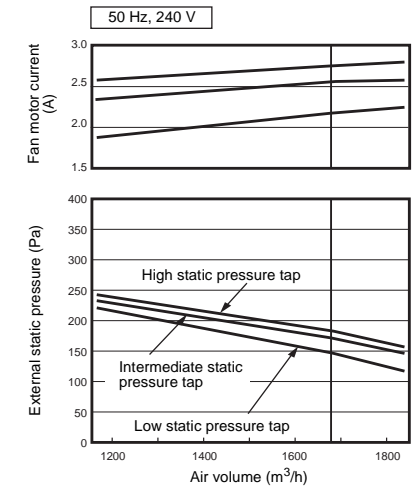
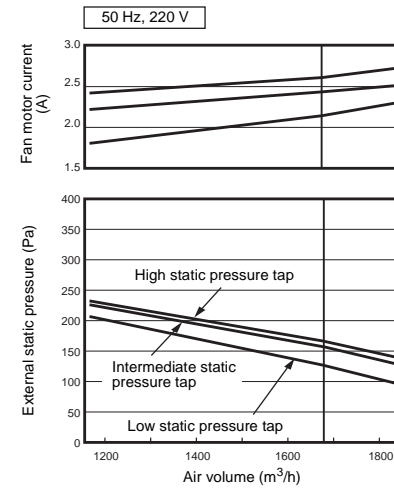

REQUIREMENT

Set a volume damper to the air supply duct, and then adjust the air volume so that it is kept in the range of 70 to 110 % against the standard air volume.

<MMD-AP096 type>

(Standard air volume: 2100 m³/h, Lower limit air volume: 1470 m³/h, Upper limit air volume: 2310 m³/h)

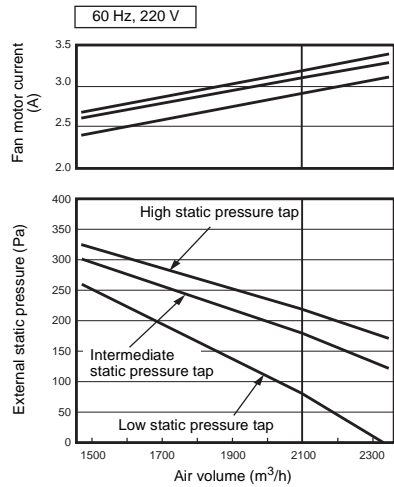
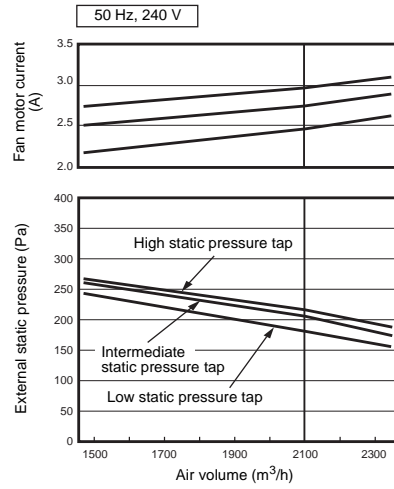
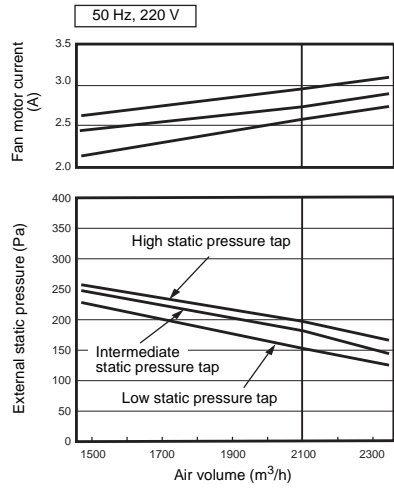

REQUIREMENT

Set a volume damper to the air supply duct, and then adjust the air volume so that it is kept in the range of 70 to 110 % against the standard air volume.

■ Wire connection change of fan motor

The motor wires for the fan have been connected to (F2) at shipment from the factory. Change the wire connection if change of the external static pressure is required due to the duct resistance.

<MMD-AP048 type>

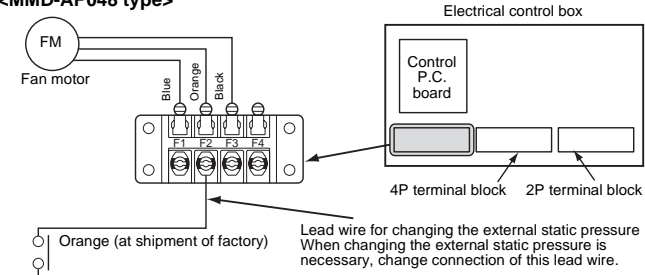

<MMD-AP072 type, AP096 type>

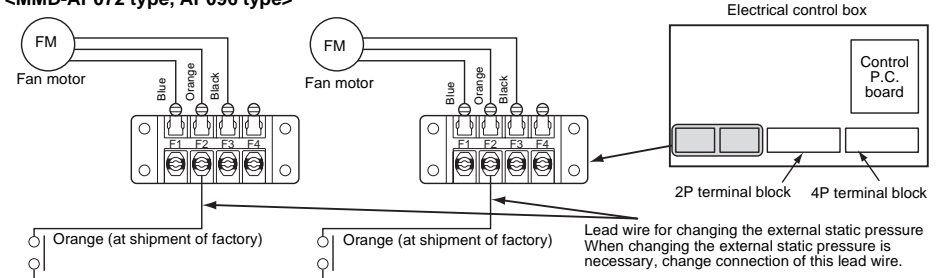

REQUIREMENT

When the external static pressure was changed, enter the changed static pressure value in the identification plate of the unit.

Terminal block No.	Fan motor wiring	Remarks
F1 (Low static pressure tap)	Blue (50 / 60 Hz)	—
F2 (Middle static pressure tap)	Orange (50 / 60 Hz)	At shipment from factory
F3 (High static pressure tap)	Black (50 / 60 Hz)	—

8 Drain piping

⚠ CAUTION

Following the Installation Manual, perform the drain piping work that water is properly drained, and apply a heat insulation not to cause a dew condensation. Inappropriate piping work may cause the water leakage in the room and wet of furniture.

REQUIREMENT

- The drain piping flows the natural drainage. Make sure to set the drain piping from the unit with descending slope of 1/50 to 1/100 and do not make up-down or trap in the midway.
- Set the horizontal pulling of the drain pipe to 20 m or less. When drain piping is too long, attach the support bracket at intervals of 1.5 m to 2 m to avoid the pipe becomes undulant as shown in figure below.

<Example for installation of the main piping (Incl. piping support)>

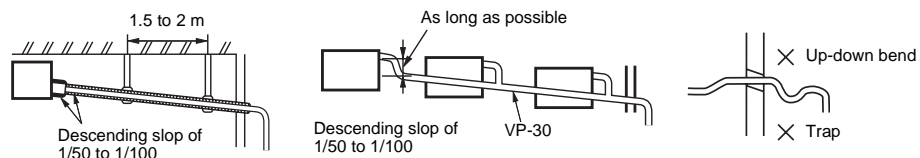

- Be sure to connect the drain pipe to the air conditioner with adhesive to avoid water leakage from the joint portion.
- Condensation may occur on the drain pipes including collective pipes. All drain pipes must be wrapped with heat insulator to prevent dew condensation. Especially a part where drain pipe is connected to the indoor unit must be firmly insulated with the provided heat insulator.

■ Pipe material, size and insulator

The following materials for piping work and insulating process are locally procured.

Pipe material	Hard vinyl chloride pipe socket for VP25
	Hard vinyl chloride pipe VP25 (Nominal outer diameter Ø32 mm)
Insulator	Foamed polyethylene foam, thickness: 10 mm or more

■ Connecting drain pipe

REQUIREMENT

- Using adhesive agent for vinyl chloride, connect the hard vinyl chloride pipes certainly so that water does not leak.
- It takes some time to dry and indurate the adhesive agent. (Refer to the manual of adhesive agent.) Do not apply any extra force on the connecting section until the adhesive agent dried.

■ Drain up

When install the drain up kit of optional accessory, read the Installation Manual supplied to a drain up kit.

■ Check the draining

Check the water drainage is surely performed at the test run. Check also no water leakage is found at the pipe connecting part.

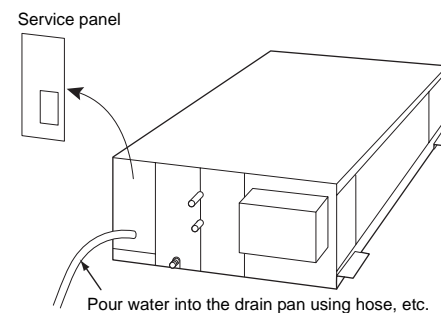

REQUIREMENT

- Be sure to check draining even if installing the unit in heating season.
- Using a kettle or hose, pour water gradually from the drain pan at the air supply port.

9 Refrigerant piping

CAUTION

When the refrigerant pipe is long, provide support brackets at intervals of 2.5 m to 3 m to clamp the refrigerant pipe. Otherwise, abnormal sound may be generated.
Use the flare nut attached with the indoor unit or R410A flare nut.
Use general copper pipes with a wall thickness of 0.8 mm for Ø12.7 mm, and with a wall thickness of 1.0 mm for Ø22.2 mm (half hard).
Do not use any copper pipes with a wall thickness less than these thicknesses.

Permissible piping length and height difference

They vary depending on the outdoor unit. For details, refer to the Installation Manual attached to the outdoor unit.

Pipe size

Model MMD-		AP048	AP072, AP096
Pipe size (mm)	Gas side	Ø15.9	Ø22.2
	Liquid side	Ø9.5	Ø12.7

- The pipe (Ø22.2 mm) at gas side is connected with brazing.

Liquid side refrigerant pipe connection

Flaring

- Cut the pipe with a pipe cutter.**
Remove burrs completely. (Remaining burrs may cause gas leakage.)
- Insert a flare nut into the pipe, and flare the pipe.**
Use the flare nut provided with the unit or the one used for the R410A refrigerant. The flaring dimensions for R410A are different from the ones used for the conventional R22 refrigerant. A new flare tool manufactured for use with the R410A refrigerant is recommended, but the conventional tool can still be used if the projection margin of the copper pipe is adjusted to be as shown in the following table.

Projection margin in flaring: B (Unit: mm)

Outer dia. of copper pipe	R410A tool used	Conventional tool used
9.5	0 to 0.5	1.0 to 1.5
12.7, 15.9		

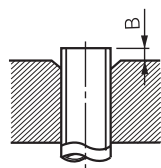

Flaring diameter size: A (Unit: mm)

Outer dia. of copper pipe	A ⁺⁰ / _{-0.4}
9.5	13.2
12.7	16.6
15.9	19.7



- In case of flaring for R410A with the conventional flare tool, pull it out approx. 0.5 mm more than that for R22 to adjust to the specified flare size. The copper pipe gauge is useful for adjusting projection margin size.
- The sealed gas was sealed at the atmospheric pressure so when the flare nut is removed, there will no "whooshing" sound: This is normal and is not indicative of trouble.
- Use two wrenches to connect the indoor unit pipe.

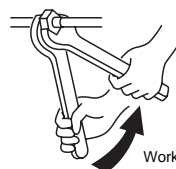

Work using double spanner

- Use the tightening torque levels as listed in the table below.

Outer dia. of connecting pipe (mm)	Tightening torque (N•m)
9.5	33 to 42 (3.3 to 4.2 kgf•m)
12.7	50 to 62 (5.0 to 6.2 kgf•m)
15.9	63 to 77 (6.3 to 7.7 kgf•m)

- Tightening torque of flare pipe connections. Pressure of R410A is higher than that of R22. (Approx. 1.6 times) Therefore, using a torque wrench, tighten the flare pipe connecting sections which connect the indoor and outdoor units of the specified tightening torque. Incorrect connections may cause not only a gas leak, but also a trouble of the refrigeration cycle.

CAUTION

Tightening with an excessive torque may crack the nut depending on installation conditions.

Gas side refrigerant pipe connection

- The brazing connections on the gas side are AP072 and AP096 models.
- Turn up the pipe heat insulator to the unit side.
- Wrap the pipe with wet cloth.

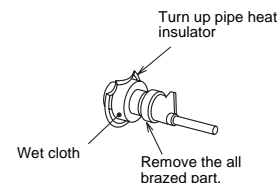

- Remove the cup on the gas side piping by using a brazing machine.

CAUTION

Do not burn the pipe heat insulator.

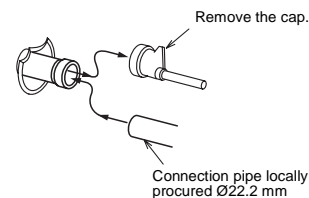

- Braze the connection piping to the joint part.

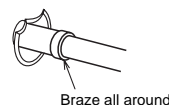

- Turn back the pipe heat insulator and tie up with a banding band.

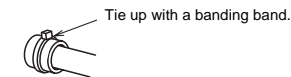

Airtight test / air purge, etc.

For air tightness test, adding refrigerant, refer to the Installation Manual attached to the outdoor unit.

CAUTION

Do not supply power to the indoor unit until the airtight test and vacuuming are completed. (If the indoor unit is powered on, the pulse motor valve is fully closed, which extends the time for vacuuming.)

Open the valve fully

Open the valve of the outdoor unit fully.

Heat insulation process

Apply heat insulation for the pipes separately at liquid side and gas side.

- For the heat insulation to the pipes at gas side, use the material with heat-resisting temperature 120 °C or higher.
- To use the attached heat insulation pipe, apply the heat insulation to the pipe connecting section of the indoor unit securely without gap.

REQUIREMENT

- Apply the heat insulation to the pipe connecting section of the indoor unit securely up to the root without exposure of the pipe. (The pipe exposed to the outside causes water leak.)
- Wrap heat insulator with its slits facing up (ceiling side).

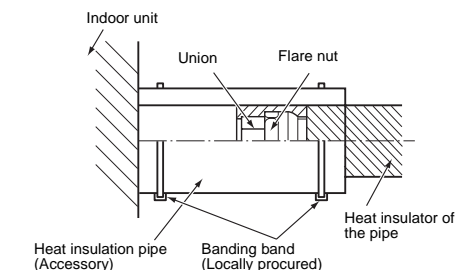

10 Electrical connection

⚠ WARNING

- Use the specified wires for wiring connect the terminals. Securely fix them to prevent external forces applied to the terminals from affecting the terminals.
Incomplete connection or fixation may cause a fire or other trouble.
- Connect earth wire. (grounding work)
Incomplete grounding cause an electric shock.
Do not connect earth wires to gas pipes, water pipes, lightning conductor or telephone earth wires.
- Appliance shall be installed in accordance with national wiring regulations.
Capacity shortage of power circuit or incomplete installation may cause an electric shock or a fire.

⚠ CAUTION

- If incorrect / incomplete wiring is carried out, it will cause an electrical fire or smoke.
- Install an earth leakage breaker that is not tripped by shock waves.
If an earth leakage breaker is not installed, an electric shock may be caused.
- Use the cord clamps attached to the product.
- Do not damage or scratch the conductive core and inner insulator of power and system inter connection wires when peeling them.
- Use the power cord and system inter connection wire of specified thickness, type, and protective devices required.
- Do not connect 220-240 V power to the terminal blocks (Ⓜ, Ⓝ, Ⓐ, Ⓑ) for control wiring. (Otherwise, the system will fail.)
- Do not damage or scratch the conductive core and inner insulator of power and system inter connection wires when peeling them.
- Perform the electric wiring so that it does not come to contact with the high-temperature part of the pipe.
The coating may melt resulting in an accident.

REQUIREMENT

- For power supply wiring, strictly conform to the Local Regulation in each country.
- For wiring of power supply of the outdoor units, follow the Installation Manual of each outdoor unit.
- After connecting wires to the terminal blocks, provide a trap and fix wires with the cord clamp.
- Run the refrigerant piping line and control wiring line in the same line.
- Do not turn on the power of the indoor unit until vacuuming of the refrigerant pipes completes.

■ Power supply wire and communication wires specifications

Power supply wire and communication wires are locally procured.

For the power supply specifications, follow to the table below. If capacity is little, it is dangerous because overheat or burnout may be caused.

For specifications of the power capacity of the outdoor unit and the power supply wires, refer to the Installation Manual attached to the outdoor unit.

Indoor unit power supply

- For the power supply of the indoor unit, prepare the exclusive power supply separated from that of the outdoor unit.
- Arrange the power supply, circuit breaker, and main switch of the indoor unit connected to the same outdoor unit so that they are commonly used.
- Power supply wire specification: Cable 3-core 2.5 mm², in conformity with Design 60245 IEC 57.

▼ Power supply

Power supply	220-240 V ~, 50 Hz 220 V ~, 60 Hz	
Power supply switch / circuit breaker or power supply wiring / fuse rating for indoor units should be selected by the accumulated total current values of the indoor units.		
Power supply wiring	Below 20 m	2.5 mm ²
	Below 50 m	3.5 mm ²

Control wiring. Central controller wiring

- 2-core with polarity wires are used for the Control wiring between indoor unit and outdoor unit and Central controller wiring.
- To prevent noise trouble, use 2-core shield wire.
- The length of the communication line means the total length of the inter-unit wire length between indoor and outdoor units added with the central control system wire length.

▼ Communication line

Control wiring between indoor units, and outdoor unit (2-core shield wire)	Wire size	(Up to 1000 m) 1.25 mm ² (Up to 2000 m) 2.0 mm ²
Central control line wiring (2-core shield wire)	Wire size	(Up to 1000 m) 1.25 mm ² (Up to 2000 m) 2.0 mm ²

Remote controller wiring

- 2-core with non-polarity wire is used for wiring of the remote controller wiring and group remote controllers wiring.

Remote controller wiring, remote controller inter-unit wiring	Wire size: 0.5 mm ² to 2.0 mm ²	
Total wire length of remote controller wiring and remote controller inter-unit wiring = L + L1 + L2 + ... Ln	In case of wired type only	Up to 500 m
	In case of wireless type included	Up to 400 m
Total wire length of remote controller inter-unit wiring = L1 + L2 + ... Ln	Up to 200 m	

⚠ CAUTION

The remote controller wire (Communication line) and AC 220-240 V wires cannot be parallel to contact each other and cannot be stored in the same conduits. If doing so, a trouble may be caused on the control system due to noise or other factor.

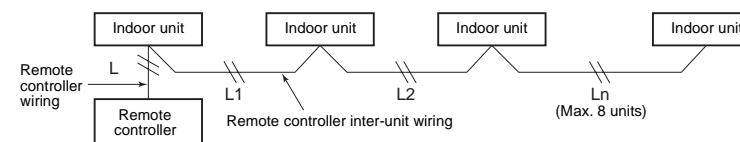

■ Wiring between indoor and outdoor units

⚠ CAUTION

The fresh air intake unit and indoor unit for air conditioning cannot be controlled as a group.

NOTE

An outdoor unit connected with control wiring between indoor and outdoor units wire becomes automatically the header unit.

▼ Wiring example

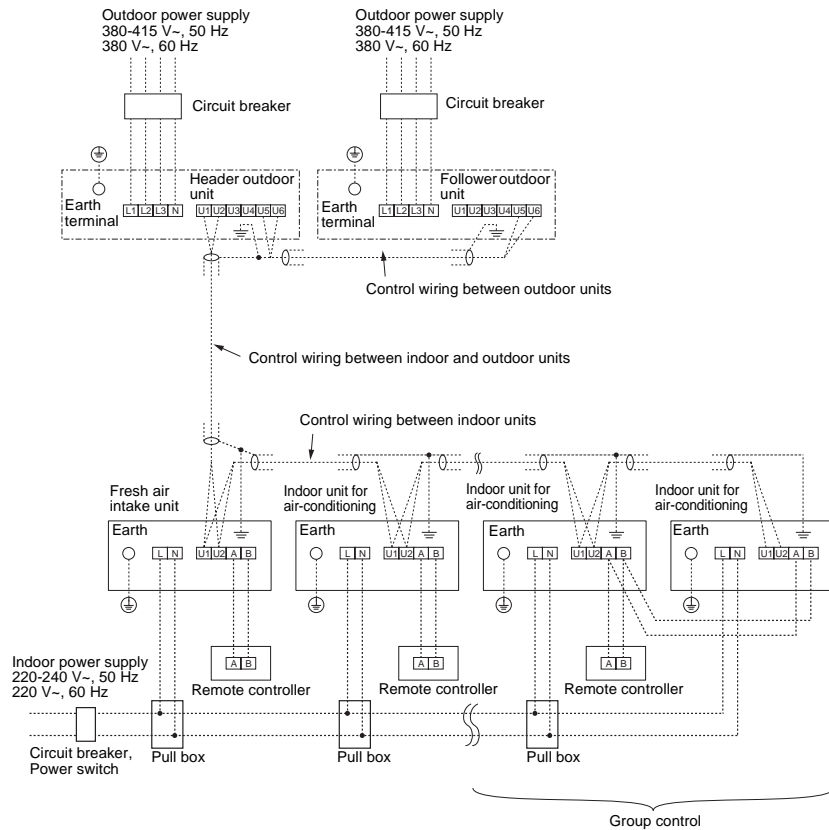

■ Wire connection

REQUIREMENT

- Connect the wires matching the terminal numbers. Incorrect connection causes a trouble.
 - Pass the wires through the bushing of wire connection holes of the indoor unit.
 - Keep a margin (Approx. 100 mm) on a wire to hang down the electrical control box at servicing or other purpose.
 - The low-voltage circuit is provided for the remote controller. (Do not connect the high-voltage circuit)
- Remove the cover of the electrical control box by taking off the mounting screws (2 positions).
 - Tighten the screws of the terminal block, and fix the wires with cord clamp attached to the electrical control box. (Do not apply tension to the connecting section of the terminal block.)
 - Set a loop for the connecting wire of the storing part of the indoor unit electrical control; otherwise the electrical control box cannot be drawn out in service time.
 - Mount the cover of the electrical control box without pinching wires.

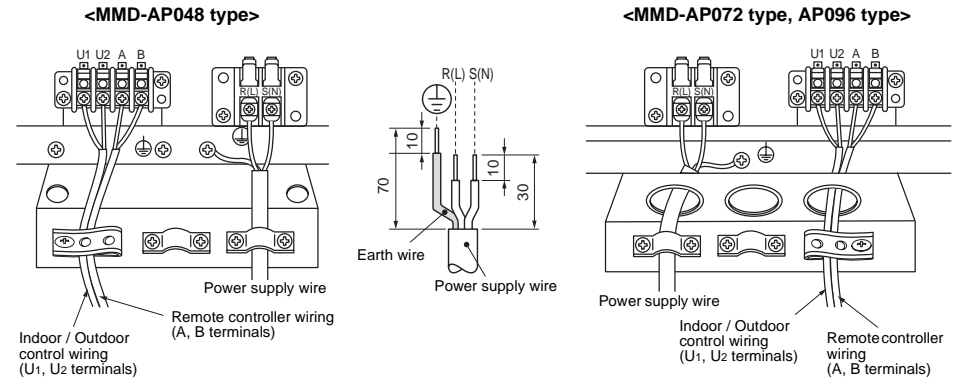

■ Remote controller wiring

Strip off approx. 9 mm the wire to be connected.

▼ Wiring diagram

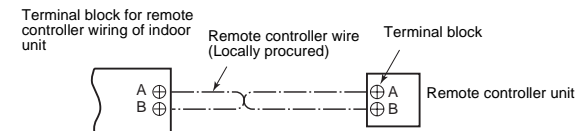

■ Address setup

Set up the addresses as per the Installation Manual supplied with the outdoor unit.

11 Applicable controls

REQUIREMENT

When the air conditioner is used for the first time, it will take some moments after the power has been turned on before the remote controller becomes available for operations: This is normal and is not indicative of trouble.

- Concerning the automatic addresses (The automatic addresses are set up by performing operations on the outdoor interface circuit board.)

While the automatic addresses are being set up, no remote controller operations can be performed. Setup takes up to 10 minutes (usually about 5 minutes).

- When the power is turned on after automatic address setup

It takes up to 10 minutes (usually about 3 minutes) for the outdoor unit to start operating after the power has been turned on.

Before the air conditioner was shipped from the factory, all units are set to [STANDARD] (factory default). If necessary, change the indoor unit settings.

The settings are changed by operating the wired remote controller.

- The settings cannot be changed using only a wireless remote controller, simple remote controller or group control remote controller by itself so install a wired remote controller separately as well.

Basic procedure for changing settings

Change the settings while the air conditioner is not working. (**Stop the air conditioner before making settings.**)

CAUTION

Set only the CODE No. shown in the following table: Do NOT set any other CODE No.

If a CODE No. not listed is set, it may not be possible to operate the air conditioner or other trouble with the product may result.

- The displays appearing during the setting process differ from the ones for previous remote controllers (AMT31E). (There are more CODE No.)

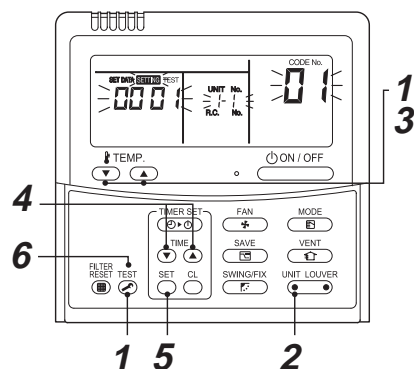

- Push and hold **TEST** button and “TEMP.” button simultaneously for at least 4 seconds. After a while, the display flashes as shown in the figure. Confirm that the CODE No. is [01].

- If the CODE No. is not [01], push **TEST** button to clear the display content, and repeat the procedure from the beginning. (No operation of the remote controller is accepted for a while after **TEST** button is pushed.)

(While air conditioners are operated under the group control, “ALL” is displayed first. When **UNIT LOUVER** is pushed, the indoor unit number displayed following “ALL” is the header unit.)

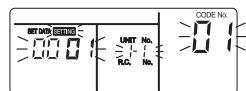

(* Display content varies with the indoor unit model.)

- Each time **UNIT LOUVER** button is pushed, indoor unit numbers in the control group change cyclically. Select the indoor unit to change settings for.

The fan of the selected unit runs and the louvers start swinging. The indoor unit for change settings can be confirmed.

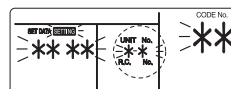

- Specify CODE No. [**] with “TEMP.” / buttons.

- Select SET DATA [****] with “TIME” / buttons.

- Push **SET** button. When the display changes from flashing to lit, the setup is completed.

- To change settings of another indoor unit, repeat from Procedure 2.
- To change other settings of the selected indoor unit, repeat from Procedure 3.

Use **SET** button to clear the settings. To make settings after **SET** button was pushed, repeat from Procedure 2.

- When settings have been completed, push **TEST** button to determine the settings.

When **TEST** button is pushed, **SETTING** flashes and then the display content disappears and the air conditioner enters the normal stop mode.

(While **SETTING** is flashing, no operation of the remote controller is accepted.)

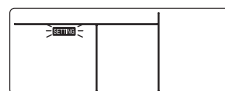

Filter sign setting

According to the installation condition, the filter sign term (Notification of filter cleaning) can be changed.

Follow to the basic operation procedure

(1 → 2 → 3 → 4 → 5 → 6).

- For the CODE No. in Procedure 3, specify [01].
- For the [SET DATA] in Procedure 4, select the SET DATA of filter sign term from the following table.

SET DATA	Filter sign term
0000	None
0001	150 H
0002	2500 H (Factory default)
0003	5000 H
0004	10000 H

Setting the level of dirtiness for the filter

The time when the filter indicator lights can be changed to half depending on the level of dirtiness.

Follow to the basic operation procedure

(1 → 2 → 3 → 4 → 5 → 6). Perform the operation.

- Specify [02] for the CODE No. in Procedure 3.
- The SET DATA in Procedure 4 is [0001].

SET DATA	0000	0001
Filter sign term	Normal	Half

Group control

In a group control, a remote controller can control up to maximum 8 units.

The fresh air intake unit and indoor unit for air conditioning cannot be controlled as a group.

- For wiring procedure and wires of the individual line (Identical refrigerant line) system, refer to “Electrical connection” in this Manual.
- Wiring between indoor units in a group is performed in the following procedure.
- Connect the indoor units by connecting the remote controller wires from the remote controller terminal blocks (A, B) of the indoor unit connected with a remote controller to the remote controller terminal blocks (A, B) of the other indoor unit. (Non-polarity)
- For address setup, refer to the Installation Manual attached to the outdoor unit.

12 Test run

■ Before test run

- Before turning on the power supply, carry out the following procedure.
 - 1) By using 500 V-megger, check that resistance of 1 MΩ or more exists between the terminal block L to N and the earth (grounding).
If resistance of less than 1 MΩ is detected, do not run the unit.
 - 2) Check the valve of the outdoor unit being opened fully.
- To protect the compressor at activation time, leave power-ON for 12 hours or more before operating.
- Do not press the electromagnetic contactor to forcibly perform a test run. (This is very dangerous because the protective device does not work.)
- Before starting a test run, set addresses by following the Installation Manual supplied with the outdoor unit.

■ Execute a test run

- When a fan operation is to be performed for an individual indoor unit, turn off the power, short CN72 on the circuit board, and then turn the power back on. (First set the operating mode to "fan," and then operate.) When the test run has been performed using this method, do NOT forget to release the shorting of CN72 after the test run is completed.

Operate the unit with the wired remote controller as usual.

For the procedure of the operation, refer to the attached Owner's Manual to the outdoor unit.

A forced test run can be executed in the following procedure even if the operation stops by thermostat-OFF.

In order to prevent a serial operation, the forced test run is released after 60 minutes have passed and returns to the usual operation.

⚠ CAUTION

Do not use the forced test run for cases other than the test run because it applies an excessive load to the devices.

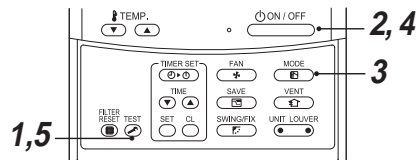

- 1 Push **TEST** button for 4 seconds or more. [TEST] is displayed on the display part and the selection of mode in the test mode is permitted.

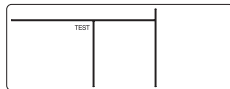

- 2 Push **ON/OFF** button.

- 3 Select the operation mode with **MODE** button, [**Cool**] or [**Heat**].
 - Do not run the air conditioner in a mode other than [**Cool**] or [**Heat**].
 - The temperature controlling function does not work during test run.
 - The detection of error is performed as usual.

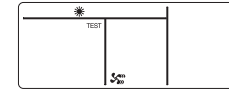

- 4 After the test run, push **ON/OFF** button to stop a test run. (Display part is same as procedure 1.)

- 5 Push **TEST** button to cancel (release from) the test run mode. ([TEST] disappears on the display and the status returns to a normal.)

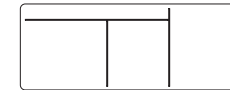

◆ Requirements for turning thermostat OFF

Cooling operation

- When the outside air temperature is lower than or equal to 19 °C.
- When the outside air temperature is lower than or equal to 3 °C above the set temperature.

Heating operation

- When the outside air temperature is lower than or equal to -5 °C.
- When the outside air temperature is higher than or equal to 15 °C.
- When the outside air temperature is higher than or equal to 3 °C above the set temperature.

13 Maintenance

<Daily maintenance>

▼ Cleaning of air filter

If  is displayed on the remote controller, maintain the air filter.

1 Push the  button to stop the operation, then turn off the circuit breaker.

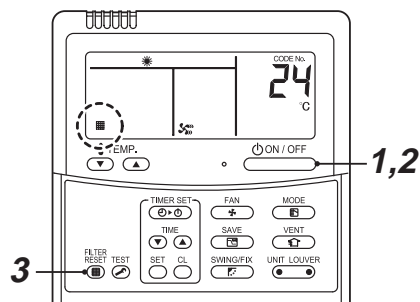

1) Take out the air filter.

2) **Long life prefilter**

Remove dust with a vacuum cleaner or rinse it off with water.

- If excessively dirty, it can be cleaned effectively by washing it with a soft brush and neutral detergent.
- After washing with water, drain off the water and dry it in the shade.

High-efficiency filter

Replace it when it is time for replacement.

- When cleaning the long life prefilter, check the dust collecting status and the reduction in air volume for the high-efficiency filter, then replace the prefilter when it is time for replacement (approximately 2500 hours of operation is recommended).

Note that the high-efficiency filter cannot be washed with water and reused.



However, the lifetime of the high-efficiency filter may be shortened depending on the intake air condition.

NOTE

- Do not wash with water that is over 50 °C. This may cause discoloration or deformation.
- Do not expose to fire. Doing so could cause a fire.
- The factory default of the filter indicator is [2500H]. If the filter becomes excessively dirty, change the setting time. Ask your dealer to describe how to change the setting time.

3) Mount the air filter.

2 Turn on the circuit breaker, then push the  button on the remote controller to start the operation.

3 After cleaning, push .  display disappears.

⚠ CAUTION

- Do not start the air conditioner while leaving air filter removed.
- Push the filter reset button. ( indication will be turn off.)

▼ Periodic Maintenance

For environmental conservation, it is strongly recommended that the indoor and outdoor units of the air conditioner in use be cleaned and maintained regularly to ensure efficient operation of the air conditioner.

When the air conditioner is operated for a long time, periodic maintenance (once a year) is recommended. Furthermore, regularly check the outdoor unit for rust and scratches, and remove them or apply rustproof treatment, if necessary.

As a general rule, when an indoor unit is operated for 8 hours or more daily, clean the indoor unit and outdoor unit at least once every 3 months. Ask a professional for this cleaning / maintenance work.

Such maintenance can extend the life of the product though it involves the owner's expense.

Failure to clean the indoor and outdoor units regularly will result in poor performance, freezing, water leakage, and even compressor failure.

Inspection before maintenance

Following inspection must be carried out by a qualified installer or qualified service person.

Parts	Inspection method
Heat exchanger	Access from inspection opening and remove the access panel. Examine the heat exchanger if there is any clogging or damages.
Fan motor	Access from inspection opening and check if any abnormal noise can be heard.
Fan	Access from inspection opening and remove the access panel. Examine the fan if there are any waggles, damages or adhesive dust.
Filter	Go to installed location and check if there are any stains or breaks on the filter.
Drain pan	Access from inspection opening and remove the access panel. Check if there is any clogging or drain water is polluted.

▼ Maintenance List

Part	Unit	Check (visual / auditory)	Maintenance
Heat exchanger	Indoor / outdoor	Dust / dirt clogging, scratches	Wash the heat exchanger when it is clogged.
Fan motor	Indoor / outdoor	Sound	Take appropriate measures when abnormal sound is generated.
Filter	Indoor	Dust / dirt, breakage	<ul style="list-style-type: none"> • Wash the filter with water when it is contaminated. • Replace it when it is damaged.
Fan	Indoor	<ul style="list-style-type: none"> • Vibration, balance • Dust / dirt, appearance 	<ul style="list-style-type: none"> • Replace the fan when vibration or balance is terrible. • Brush or wash the fan when it is contaminated.
Air intake / discharge grilles	Indoor / outdoor	Dust / dirt, scratches	Fix or replace them when they are deformed or damaged.
Drain pan	Indoor	Dust / dirt clogging, drain contamination	Clean the drain pan and check the downward slope for smooth drainage.
Ornamental panel, louvers	Indoor	Dust / dirt, scratches	Wash them when they are contaminated or apply repair coating.
Exterior	Outdoor	<ul style="list-style-type: none"> • Rust, peeling of insulator • Peeling / lift of coat 	Apply repair coating.

14 Troubleshooting

Confirmation and check

When an error occurred in the air conditioner, an error code and indoor UNIT No. appear on the display part of the remote controller.

The error code is only displayed during the operation.

If the display disappears, operate the air conditioner according to the following "Confirmation of error log" for confirmation.

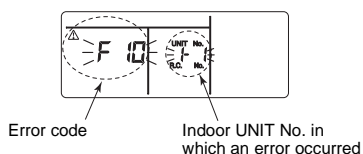

Confirmation of error log

When an error occurred on the air conditioner, the error log can be confirmed with the following procedure. (The error log is stored in memory up to 4 errors.)

The log can be confirmed from both operating status and stop status.

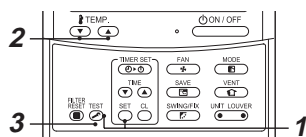

1 When **SET** and **TEST** buttons are pushed simultaneously for 4 seconds or more, the following display appears.

If **△** is displayed, the mode enters in the error log mode.

- [01: Order of error log] is displayed in CODE No.
- [Error code] is displayed in CHECK.
- [Indoor unit address in which an error occurred] is displayed in Unit No.

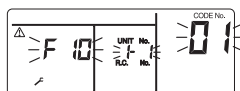

2 Every pushing of **TEMP.** button used to set temperature, the error log stored in memory is displayed in order.

The numbers in CODE No. indicate CODE No. [01] (latest) → [04] (oldest).

REQUIREMENT

Do not push **CL** button because all the error log of the indoor unit will be deleted.

3 After confirmation, push **TEST** button to return to the usual display.

Check method

On the wired remote controller, central control remote controller and the interface P.C. board of the outdoor unit (I/F), or 7-segment display (on the outdoor interface P.C. board) to display the operation is provided. Therefore the operation status can be known. Using this self-diagnosis function, a trouble or position with error of the air conditioner can be found as shown in the table below.

Check code list

The following list shows each check code. Find the check contents from the list according to part to be checked.

- In case of check from indoor remote controller: See "Wired remote controller display" in the list.
- In case of check from outdoor unit: See "Outdoor unit 7-segment display" in the list.

○: Lighting, ◻: Flashing, ●: Goes off
IPDU: Intelligent Power Drive Unit

ALT: Flashing is alternately when there are two flashing LED.
SIM: Simultaneous flashing when there are two flashing LED.

Wired remote controller display	Check code		Check code name	Judging device
	Outdoor unit 7-segment display	Auxiliary code		
E01	—	—	Communication error between indoor unit and remote controller (Detected at remote controller side)	Remote controller
E02	—	—	Remote controller transmission error	Remote controller
E03	—	—	Communication error between indoor unit and remote controller (Detected at indoor unit side)	Indoor unit
E04	—	—	Communication circuit error between indoor / outdoor unit (Detected at indoor unit side)	Indoor unit
E06	E06	No. of indoor units in which sensor has been normally received	Decrease of No. of indoor units	I/F
—	E07	—	Communication circuit error between indoor / outdoor unit (Detected at outdoor unit side)	I/F
E08	E08	Duplicated indoor unit addresses	Duplicated indoor unit addresses	Indoor unit • I/F
E09	—	—	Duplicated master remote controllers	Remote controller
E10	—	—	Communication error between indoor unit MC	Indoor unit
E12	E12	01:Indoor / Outdoor units communication 02:Outdoor / Outdoor units communication	Automatic address start error	I/F
E15	E15	—	No indoor unit during automatic addressing	I/F
E16	E16	00:Capacity over 01 ~:No. of connected units	Capacity over / No. of connected indoor units	I/F
E18	—	—	Communication error between header and follower units Indoor unit	Indoor unit
E19	E19	00:No header 02:Two or more header units	Outdoor header units quantity error	I/F
E20	E20	01:Outdoor unit of other line connected 02:Indoor unit of other line connected	Other line connected during automatic address	I/F

Check code			Check code name	Judging device
Wired remote controller display	Outdoor unit 7-segment display			
		Auxiliary code		
E21	E21	02:No header unit 00:Multiple number of header units	Error in number of heat storage master units	I/F
E22	E22	—	Reduction in number of heat storage units	I/F
E23	E23	—	Sending error in communication between outdoor units Error in number of heat storage units (trouble with reception)	I/F
E25	E25	—	Duplicated follower outdoor addresses	I/F
E26	E26	No. of outdoor units which received signal normally	Decrease of No. of connected outdoor units	I/F
E28	E28	Detected outdoor unit number	Follower outdoor unit error	I/F
E31	E31	Number of IPDU (*1)	IPDU communication error	I/F
F01	—	—	Indoor unit TCJ sensor error	Indoor unit
F02	—	—	Indoor unit TC2 sensor error	Indoor unit
F03	—	—	Indoor unit TC1 sensor error	Indoor unit
F04	F04	—	TD1 sensor error	I/F
F05	F05	—	TD2 sensor error	I/F
F06	F06	01:TE1 sensor 02:TE2 sensor	TE1 sensor error TE2 sensor error	I/F
F07	F07	—	TL sensor error	I/F
F08	F08	—	TO sensor error	I/F
F10	—	—	Indoor unit TA sensor error	Indoor unit
F12	F12	—	TS1 sensor error	I/F
F13	F13	01:Comp. 1 side 02:Comp. 2 side 03:Comp. 3 side	TH sensor error	IPDU
F15	F15	—	Outdoor unit temp. sensor miscabling (TE, TL)	I/F
F16	F16	—	Outdoor unit pressure sensor miscabling (Pd, Ps)	I/F
F22	F22	—	TD3 sensor error	I/F
F23	F23	—	Ps sensor error	I/F
F24	F24	—	Pd sensor error	I/F
F29	—	—	Indoor unit other error	Indoor unit
F31	F31	—	Indoor unit EEPROM error	I/F
H01	H01	01:Comp. 1 side 02:Comp. 2 side 03:Comp. 3 side	Compressor break down	IPDU
H02	H02	01:Comp. 1 side 02:Comp. 2 side 03:Comp. 3 side	Compressor trouble (lock)	IPDU
H03	H03	01:Comp. 1 side 02:Comp. 2 side 03:Comp. 3 side	Current detect circuit system error	IPDU
H04	H04	—	Comp. 1 case thermo operation	I/F
H05	H05	—	TD1 sensor miswiring	I/F

Check code			Check code name	Judging device
Wired remote controller display	Outdoor unit 7-segment display			
		Auxiliary code		
H06	H06	—	Low pressure protective operation	I/F
H07	H07	—	Oil level down detective protection	I/F
H08	H08	01:TK1 sensor error 02:TK2 sensor error 03:TK3 sensor error 04:TK4 sensor error 05:TK5 sensor error	Oil level detective temp sensor error	I/F
H14	H14	—	Comp. 2 case thermo operation	I/F
H15	H15	—	TD2 sensor miswiring	I/F
H16	H16	01:TK1 oil circuit system error 02:TK2 oil circuit system error 03:TK3 oil circuit system error 04:TK4 oil circuit system error 05:TK5 oil circuit system error	Oil level detective circuit error	I/F
H25	H25	—	TD3 sensor miswiring	I/F
L03	—	—	Indoor unit centre unit duplicated	Indoor unit
L04	L04	—	Outdoor unit line address duplicated	I/F
L05	—	—	Duplicated indoor units with priority (Displayed in indoor unit with priority)	I/F
L06	L06	No. of indoor units with priority	Duplicated indoor units with priority (Displayed in unit other than indoor unit with priority)	I/F
L07	—	—	Group line in individual indoor unit	Indoor unit
L08	L08	—	Indoor unit group / Address unset	Indoor unit, I/F
L09	—	—	Indoor unit capacity unset	Indoor unit
L10	L10	—	Outdoor unit capacity unset	I/F
L17	—	—	Outdoor unit type mismatch error	I/F
L20	—	—	Duplicated central control addresses	AI-NET, Indoor unit
L26	L26	Number of heat storage units connected	Too many heat storage units connected	I/F
L27	L27	Number of heat storage units connected	Error in number of heat storage units connected	I/F
L28	L28	—	Too many outdoor units connected	I/F
L29	L29	Number of IPDU (*1)	No. of IPDU error	I/F
L30	L30	Detected indoor unit address	Indoor unit outside interlock	Indoor unit
—	L31	—	Extended I/C error	I/F
P01	—	—	Indoor fan motor error	Indoor unit
P03	P03	—	Discharge temp. TD1 error	I/F
P04	P04	01:Comp. 1 side 02:Comp. 2 side 03:Comp. 3 side	High-pressure SW system operation	IPDU
P05	P05	00: 01:Comp. 1 side 02:Comp. 2 side 03:Comp. 3 side	Phase missing detection / Power failure detection Inverter DC voltage error (comp.) Inverter DC voltage error (comp.) Inverter DC voltage error (comp.)	I/F

Check code			Check code name	Judging device
Wired remote controller display	Outdoor unit 7-segment display			
		Auxiliary code		
P07	P07	01:Comp. 1 side 02:Comp. 2 side 03:Comp. 3 side	Heat sink overheat error	IPDU, I/F
P09	P09	Detected heat storage address	No heat storage unit water error	Heat storage unit
P10	P10	Detected indoor unit address	Indoor unit overflow error	Indoor unit
P12	—	—	Indoor unit fan motor error	Indoor unit
P13	P13	—	Outdoor liquid back detection error	I/F
P15	P15	01:TS condition 02:TD condition	Gas leak detection	I/F
P17	P17	—	Discharge temp. TD2 error	I/F
P18	P18	—	Discharge temp. TD3 error	I/F
P19	P19	Detected outdoor unit number	4-way valve inverse error	I/F
P20	P20	—	High-pressure protective operation	I/F
P22	P22	0*:IGBT circuit 1*:Position detective circuit error 3*:Motor lock error 4*:Motor current detection C*:TH sensor error D*:TH sensor error E*:Inverter DC voltage error (outdoor unit fan)	Outdoor unit fan IPDU error Note: Ignore 0 to F displayed in "" position.	IPDU
P26	P26	01:Comp. 1 side 02:Comp. 2 side 03:Comp. 3 side	G-TR short protection error	IPDU
P29	P29	01:Comp. 1 side 02:Comp. 2 side 03:Comp. 3 side	Comp. position detective circuit system error	IPDU
P31	—	—	Other indoor unit error (Group follower indoor unit error)	Indoor unit
—	—	—	Error in indoor unit group	AI-NET
—	—	—	AI-NET communication system error	AI-NET
—	—	—	Duplicated network adapters	AI-NET

*1 Number of IPDU

01: Comp. 1	05: Comp. 1 + Comp. 3	09: Comp. 1 + Fan	0D: Comp. 1 + Comp. 3 + Fan
02: Comp. 2	06: Comp. 2 + Comp. 3	0A: Comp. 2 + Fan	0E: Comp. 2 + Comp. 3 + Fan
03: Comp. 1 + Comp. 2	07: Comp. 1 + Comp. 2 + Comp. 3	0B: Comp. 1 + Comp. 2 + Fan	0F: Comp. 1 + Comp. 2 + Comp. 3 + Fan
04: Comp. 3	08: Fan	0C: Comp. 3 + Fan	

Error detected by TCC-LINK central control device

Check code			Check code name	Judging device
Central control device indication	Outdoor unit 7-segment display			
		Auxiliary code		
C05	—	—	Sending error in TCC-LINK central control device	TCC-LINK
C06	—	—	Receiving error in TCC-LINK central control device	TCC-LINK
C12	—	—	Batch alarm of general-purpose equipment control interface	General-purpose equipment, I/F
P30	Differs according to error contents of unit with occurrence of alarm		Group control follower unit error	TCC-LINK
	—	—	Decrease of No. of indoor units	

TCC-LINK: TOSHIBA Carrier Communication Link.

Warnings on Refrigerant Leakage

Check of Concentration Limit

The room in which the air conditioner is to be installed requires a design that in the event of refrigerant gas leaking out, its concentration will not exceed a set limit.

The refrigerant R410A which is used in the air conditioner is safe, without the toxicity or combustibility of ammonia, and is not restricted by laws to be imposed which protect the ozone layer. However, since it contains more than air, it poses the risk of suffocation if its concentration should rise excessively. Suffocation from leakage of R410A is almost non-existent. With the recent increase in the number of high concentration buildings, however, the installation of multi air conditioner systems is on the increase because of the need for effective use of floor space, individual control, energy conservation by curtailing heat and carrying power etc.

Most importantly, the multi air conditioner system is able to replenish a large amount of refrigerant compared with conventional individual air conditioners. If a single unit of the multi conditioner system is to be installed in a small room, select a suitable model and installation procedure so that if the refrigerant accidentally leaks out, its concentration does not reach the limit (and in the event of an emergency, measures can be made before injury can occur).

In a room where the concentration may exceed the limit, create an opening with adjacent rooms, or install mechanical ventilation combined with a gas leak detection device. The concentration is as given below.

$$\frac{\text{Total amount of refrigerant (kg)}}{\text{Min. volume of the indoor unit installed room (m}^3\text{)}} \leq \text{Concentration limit (kg/m}^3\text{)}$$

The concentration limit of R410A which is used in multi air conditioners is 0.3 kg/m³.

▼ NOTE 1

If there are 2 or more refrigerating systems in a single refrigerating device, the amounts of refrigerant should be as charged in each independent device.

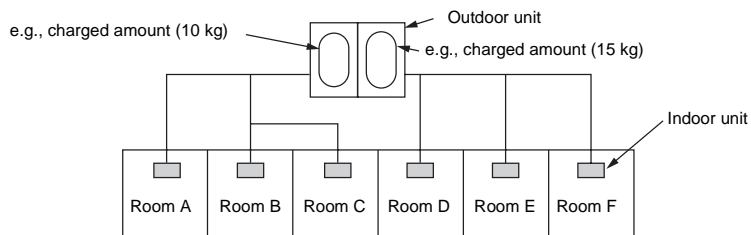

For the amount of charge in this example:

- The possible amount of leaked refrigerant gas in rooms A, B and C is 10 kg.
- The possible amount of leaked refrigerant gas in rooms D, E and F is 15 kg.

▼ NOTE 2

The standards for minimum room volume are as follows.

- 1) No partition (shaded portion)

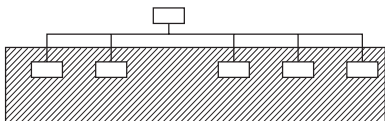

Important

- 2) When there is an effective opening with the adjacent room for ventilation of leaking refrigerant gas (opening without a door, or an opening 0.15 % or larger than the respective floor spaces at the top or bottom of the door).

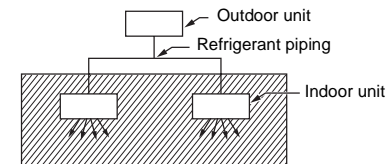

- 3) If an indoor unit is installed in each partitioned room and the refrigerant piping is interconnected, the smallest room of course becomes the object. But when a mechanical ventilation is installed interlocked with a gas leakage detector in the smallest room where the density limit is exceeded, the volume of the next smallest room becomes the object.

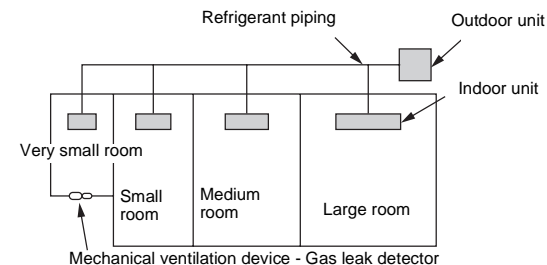

▼ NOTE 3

The minimum indoor floor area compared with the amount of refrigerant is roughly as follows: (When the ceiling is 2.7 m high)

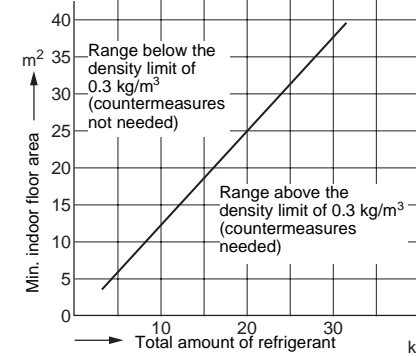

■ Confirmation of indoor unit setup

Prior to delivery to the customer, check the address and setup of the indoor unit, which has been installed in this time and fill the check sheet (Table below). Data of four units can be entered in this check sheet. Copy this sheet according to the No. of the indoor units. If the installed system is a group control system, use this sheet by entering each line system into each installation manual attached to the other indoor units.

REQUIREMENT

This check sheet is required for maintenance after installation. Fill this sheet and then pass this Installation Manual to the customers.

Indoor unit setup check sheet

Indoor unit		Indoor unit		Indoor unit		Indoor unit		
Room name	Room name	Room name	Room name	Room name	Room name	Room name	Room name	
Model	Model	Model	Model	Model	Model	Model	Model	
Check indoor unit address. (For check method, refer to APPLICABLE CONTROLS in this manual.) *In case of a single system, it is unnecessary to enter the indoor address. (CODE NO.: Line [12], Indoor [13], Group [14], Central control [03])								
Line	Indoor	Group	Line	Indoor	Group	Line	Indoor	Group
Central control address		Central control address		Central control address		Central control address		
Various setup		Various setup		Various setup		Various setup		
Have you changed lighting time of filter sign? If not, fill check mark [x] in [NO CHANGE], and fill check mark [x] in [ITEM] if changed, respectively. (For check method, refer to APPLICABLE CONTROLS in this manual.)								
Filter sign lighting time (CODE NO. [01])		Filter sign lighting time (CODE NO. [01])		Filter sign lighting time (CODE NO. [01])		Filter sign lighting time (CODE NO. [01])		
<input type="checkbox"/> NO CHANGE <input type="checkbox"/> NONE <input type="checkbox"/> 150H <input type="checkbox"/> 2500H <input type="checkbox"/> 5000H <input type="checkbox"/> 10000H		<input type="checkbox"/> NO CHANGE <input type="checkbox"/> NONE <input type="checkbox"/> 150H <input type="checkbox"/> 2500H <input type="checkbox"/> 5000H <input type="checkbox"/> 10000H		<input type="checkbox"/> NO CHANGE <input type="checkbox"/> NONE <input type="checkbox"/> 150H <input type="checkbox"/> 2500H <input type="checkbox"/> 5000H <input type="checkbox"/> 10000H		<input type="checkbox"/> NO CHANGE <input type="checkbox"/> NONE <input type="checkbox"/> 150H <input type="checkbox"/> 2500H <input type="checkbox"/> 5000H <input type="checkbox"/> 10000H		
Have you changed detected temp. shift value? If not, fill check mark [x] in [NO CHANGE], and fill check mark [x] in [ITEM] if changed, respectively. (For check method, refer to APPLICABLE CONTROLS in this manual.)								
Setting the level of dirtiness for the filter (CODE NO. [02])		Setting the level of dirtiness for the filter (CODE NO. [02])		Setting the level of dirtiness for the filter (CODE NO. [02])		Setting the level of dirtiness for the filter (CODE NO. [02])		
<input type="checkbox"/> Normal <input type="checkbox"/> Half		<input type="checkbox"/> Normal <input type="checkbox"/> Half		<input type="checkbox"/> Normal <input type="checkbox"/> Half		<input type="checkbox"/> Normal <input type="checkbox"/> Half		
Incorporation of parts sold separately		Incorporation of parts sold separately		Incorporation of parts sold separately		Incorporation of parts sold separately		
Have you incorporated the following parts sold separately? If incorporated, fill check mark [x] in each [ITEM]. (When incorporating, the setup change is necessary in some cases. For setup change method, refer to Installation Manual attached to each part sold separately.)								
Others ()		Others ()		Others ()		Others ()		
Others ()		Others ()		Others ()		Others ()		

EH99887501

TOSHIBA CARRIER CORPORATION
336 TADEHARA, FUJI-SHI, SHIZUOKA-KEN 416-8521 JAPAN