



EB99831601

TOSHIBA

AIR CONDITIONER (SPLIT TYPE)

Installation Manual

R32

Outdoor Unit

Model name:

RAV-GP1101AT8-E

RAV-GP1101AT8J-E

RAV-GP1401AT8-E

RAV-GP1401AT8J-E

RAV-GP1601AT8-E

RAV-GP1601AT8J-E

For commercial use

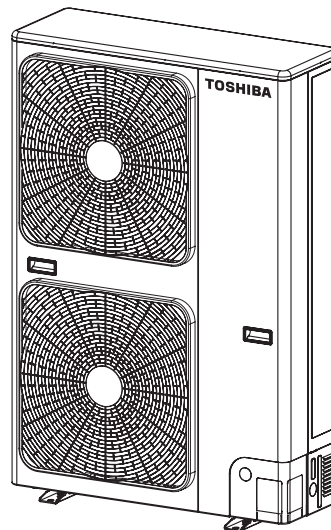

Original instruction

ADOPTION OF R32 REFRIGERANT

This air conditioner adopts the HFC refrigerant (R32) which does not destroy the ozone layer.
This outdoor unit is designed exclusively for use with R32 refrigerant. Be sure to use in combination with a R32 refrigerant indoor unit.

Regulation of harmonic current

RAV-GP1101AT8(J)-E, RAV-GP1401AT8(J)-E, RAV-GP1601AT8(J)-E
Equipment complying with EN 61000-3-12

This unit complies with EN 61000-3-11.
However, the impedance of the power supply system to be connected to the unit at the incoming power point must be less than the Z_{max} given below.
In order to meet this condition, consult with the supply authority as required.

RAV-GP1101AT8(J)-E, RAV-GP1401AT8(J)-E, RAV-GP1601AT8(J)-E $Z_{max} = 0.437 (\Omega)$

In addition, it is recommended that voltage drops occurring during the unit's operation in the area at the power input shall be around 3.3% of the nominal power-supply voltage or less.

Contents

1	PRECAUTIONS FOR SAFETY	5
1	MESURES DE SECURITE	13
1	SICHERHEITSMASSNAHMEN	21
1	PRECAUZIONI DI SICUREZZA	29
1	PRECAUCIONES DE SEGURIDAD	37
1	PRECAUÇÕES DE SEGURANÇA	45
1	VEILIGHEIDSVOORSCHRIFTEN	53
1	ΠΡΟΦΥΛΑΞΕΙΣ ΑΣΦΑΛΕΙΑΣ	61
1	ΜΕΡΗ ΠΡΕΔΟΠΟΡΟЖНОСТИ	69
2	ACCESSORY PARTS	74
3	INSTALLATION OF R32 REFRIGERANT AIR CONDITIONER	74
4	INSTALLATION CONDITIONS	75
5	REFRIGERANT PIPING	78
6	AIR PURGING	81
7	ELECTRICAL WORK	84
8	EARTHING	86
9	FINISHING	86
10	TEST RUN	86
11	ANNUAL MAINTENANCE	87
12	AIR CONDITIONER OPERATING CONDITIONS	87
13	FUNCTIONS TO BE IMPLEMENTED LOCALLY	87
14	TROUBLESHOOTING	88
15	APPENDIX	88
16	SPECIFICATIONS	91

Thank you for purchasing this Toshiba air conditioner.

Please read carefully through these instructions including important information which complies with the "Machinery Directive" (Directive 2006/42/EC), and ensure that you understand them.

After reading these instructions, be sure to keep them in a safe place together with the Owner's Manual and Installation Manual supplied with your product.

Generic Denomination: Air Conditioner

Definition of Qualified Installer or Qualified Service Person

The air conditioner must be installed, maintained, repaired and removed by a qualified installer or qualified service person. When any of these jobs is to be done, ask a qualified installer or qualified service person to do them for you. A qualified installer or qualified service person is an agent who has the qualifications and knowledge described in the table below.

Agent	Qualifications and knowledge which the agent must have
Qualified installer	<ul style="list-style-type: none"> • The qualified installer is a person who installs, maintains, relocates and removes the air conditioners made by Toshiba Carrier Corporation. He or she has been trained to install, maintain, relocate and remove the air conditioners made by Toshiba Carrier Corporation or, alternatively, he or she has been instructed in such operations by an individual or individuals who have been trained and is thus thoroughly acquainted with the knowledge related to these operations. • The qualified installer who is allowed to do the electrical work involved in installation, relocation and removal has the qualifications pertaining to this electrical work as stipulated by the local laws and regulations, and he or she is a person who has been trained in matters relating to electrical work on the air conditioners made by Toshiba Carrier Corporation or, alternatively, he or she has been instructed in such matters by an individual or individuals who have been trained and is thus thoroughly acquainted with the knowledge related to this work. • The qualified installer who is allowed to do the refrigerant handling and piping work involved in installation, relocation and removal has the qualifications pertaining to this refrigerant handling and piping work as stipulated by the local laws and regulations, and he or she is a person who has been trained in matters relating to refrigerant handling and piping work on the air conditioners made by Toshiba Carrier Corporation or, alternatively, he or she has been instructed in such matters by an individual or individuals who have been trained and is thus thoroughly acquainted with the knowledge related to this work. • The qualified installer who is allowed to work at heights has been trained in matters relating to working at heights with the air conditioners made by Toshiba Carrier Corporation or, alternatively, he or she has been instructed in such matters by an individual or individuals who have been trained and is thus thoroughly acquainted with the knowledge related to this work.

Qualified service person	<ul style="list-style-type: none"> • The qualified service person is a person who installs, repairs, maintains, relocates and removes the air conditioners made by Toshiba Carrier Corporation. He or she has been trained to install, repair, maintain, relocate and remove the air conditioners made by Toshiba Carrier Corporation or, alternatively, he or she has been instructed in such operations by an individual or individuals who have been trained and is thus thoroughly acquainted with the knowledge related to these operations. • The qualified service person who is allowed to do the electrical work involved in installation, repair, relocation and removal has the qualifications pertaining to this electrical work as stipulated by the local laws and regulations, and he or she is a person who has been trained in matters relating to electrical work on the air conditioners made by Toshiba Carrier Corporation or, alternatively, he or she has been instructed in such matters by an individual or individuals who have been trained and is thus thoroughly acquainted with the knowledge related to this work. • The qualified service person who is allowed to do the refrigerant handling and piping work involved in installation, repair, relocation and removal has the qualifications pertaining to this refrigerant handling and piping work as stipulated by the local laws and regulations, and he or she is a person who has been trained in matters relating to refrigerant handling and piping work on the air conditioners made by Toshiba Carrier Corporation or, alternatively, he or she has been instructed in such matters by an individual or individuals who have been trained and is thus thoroughly acquainted with the knowledge related to this work. • The qualified service person who is allowed to work at heights has been trained in matters relating to working at heights with the air conditioners made by Toshiba Carrier Corporation or, alternatively, he or she has been instructed in such matters by an individual or individuals who have been trained and is thus thoroughly acquainted with the knowledge related to this work.
--------------------------	--

Definition of Protective Gear

When the air conditioner is to be transported, installed, maintained, repaired or removed, wear protective gloves and "safety" work clothing.

In addition to such normal protective gear, wear the protective gear described below when undertaking the special work detailed in the table below.

Failure to wear the proper protective gear is dangerous because you will be more susceptible to injury, burns, electric shocks and other injuries.

Work undertaken	Protective gear worn
All types of work	Protective gloves "Safety" working clothing
Electrical-related work	Gloves to provide protection from electric shock Insulating shoes Clothing to provide protection from electric shock
Work done at heights (50 cm or more)	Helmets for use in industry
Transportation of heavy objects	Shoes with additional protective toecap
Repair of outdoor unit	Gloves to provide protection from electric shock

■ Center of gravity

(Unit: mm)

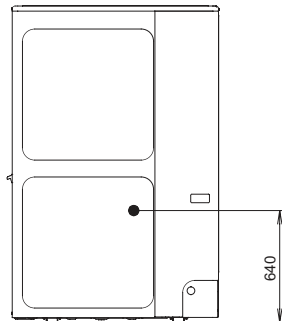
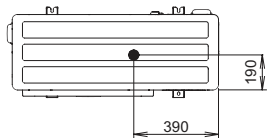







These safety cautions describe important matters concerning safety to prevent injury to users or other people and damages to property. Please read through this manual after understanding the contents below (meanings of indications), and be sure to follow the description.



Indication	Meaning of Indication
WARNING	Text set off in this manner indicates that failure to adhere to the directions in the warning could result in serious bodily harm (*1) or loss of life if the product is handled improperly.
CAUTION	Text set off in this manner indicates that failure to adhere to the directions in the caution could result in slight injury (*2) or damage (*3) to property if the product is handled improperly.

- *1: Serious bodily harm indicates loss of eyesight, injury, burns, electric shock, bone fracture, poisoning, and other injuries which leave aftereffect and require hospitalization or long-term treatment as an outpatient.
- *2: Slight injury indicates injury, burns, electric shock, and other injuries which do not require hospitalization or long-term treatment as an outpatient.
- *3: Damage to property indicates damage extending to buildings, household effects, domestic livestock, and pets.

■ **Warning Indications on the Air Conditioner Unit**

	WARNING (Risk of fire)	This mark is for R32 refrigerant only. Refrigerant type is written on nameplate of outdoor unit. In case that refrigerant type is R32, this unit uses a flammable refrigerant. If refrigerant leaks and comes in contact with fire or heating part, it will create harmful gas and there is risk of fire.
		Read the OWNER'S MANUAL carefully before operation.
		Service personnel are required to carefully read the OWNER'S MANUAL and INSTALLATION MANUAL before operation.
		Further information is available in the OWNER'S MANUAL, INSTALLATION MANUAL, and the like.

Warning indication		Description
	WARNING ELECTRICAL SHOCK HAZARD Disconnect all remote electric power supplies before servicing.	WARNING ELECTRICAL SHOCK HAZARD Disconnect all remote electric power supplies before servicing.
	WARNING Moving parts. Do not operate unit with grille removed. Stop the unit before the servicing.	WARNING Moving parts. Do not operate unit with grille removed. Stop the unit before the servicing.
	CAUTION High temperature parts. You might get burned when removing this panel.	CAUTION High temperature parts. You might get burned when removing this panel.

	CAUTION Do not touch the aluminum fins of the unit. Doing so may result in injury.	CAUTION Do not touch the aluminum fins of the unit. Doing so may result in injury.
	CAUTION BURST HAZARD Open the service valves before the operation, otherwise there might be the burst.	CAUTION BURST HAZARD Open the service valves before the operation, otherwise there might be the burst.

1 PRECAUTIONS FOR SAFETY

The manufacturer shall not assume any liability for the damage caused by not observing the description of this manual.

⚠ WARNING

General

- Before starting to install the air conditioner, read carefully through the Installation Manual, and follow its instructions to install the air conditioner.
- Only a qualified installer(*1) or qualified service person(*1) is allowed to install the air conditioner. If the air conditioner is installed by an unqualified individual, a fire, electric shocks, injury, water leakage, noise and/or vibration may result.
- Do not use any refrigerant different from the one specified for complement or replacement. Otherwise, abnormally high pressure may be generated in the refrigeration cycle, which may result in a failure or explosion of the product or an injury to your body.
- When transporting the air conditioner, use a forklift and when moving the air conditioner by hand, move the unit with 4 people.
- Before opening the intake grille of the indoor unit or service panel of the outdoor unit, set the circuit breaker to the OFF position. Failure to set the circuit breaker to the OFF position may result in electric shocks through contact with the interior parts. Only a qualified installer(*1) or qualified service person(*1) is allowed to remove the intake grille of the indoor unit or service panel of the outdoor unit and do the work required.

- Before carrying out the installation, maintenance, repair or removal work, be sure to set the circuit breaker to the OFF position. Otherwise, electric shocks may result.
- Place a “Work in progress” sign near the circuit breaker while the installation, maintenance, repair or removal work is being carried out. There is a danger of electric shocks if the circuit breaker is set to ON by mistake.
- Only a qualified installer(*1) or qualified service person(*1) is allowed to undertake work at heights using a stand of 50 cm or more.
- Wear protective gloves and safety work clothing during installation, servicing and removal.
- Do not touch the aluminum fin of the outdoor unit. You may injure yourself if you do so. If the fin must be touched for some reason, first put on protective gloves and safety work clothing, and then proceed.
- Do not climb onto or place objects on top of the outdoor unit. You may fall or the objects may fall off top of the outdoor unit and result in injury.
- When working at heights, use a ladder which complies with the ISO 14122 standard, and follow the procedure in the ladder’s instructions. Also wear a helmet for use in industry as protective gear to undertake the work.
- When working at heights, put a sign in place so that no-one will approach the work location, before proceeding with the work. Parts and other objects may fall from above, possibly injuring a person below.
- You shall ensure that the air conditioner is transported in stable condition. If any part of the product is broken, contact the dealer.
- Do not modify the products. Do not also disassemble or modify the parts. It may cause a fire, electric shock or injury.
- This appliance is intended to be used by expert or trained users in shops, in light industry, or for commercial use by lay persons.

About the refrigerant

- This product contains fluorinated greenhouse gases.
- Do not vent gases to the atmosphere.
- The appliance shall be stored in a room without continuously operating ignition sources (for example: open flames, an operating gas appliance or an operating electric heater).
- Do not pierce or burn refrigerant cycle parts.
- Do not use means to accelerate the defrosting process or to clean, other than those recommended by the manufacturer.
- Be aware that refrigerants may not contain an odour.
- The refrigerant inside the unit is flammable. If the refrigerant leaks in the room and comes in contact with fire from a burner, a heater, or a cooker, it may result in fire or the formation of a harmful gas.
- Turn off any combustible heating devices, ventilate the room, and contact the dealer from which you purchased the unit.
- Do not use the unit until a service person confirms that the portion from which the refrigerant leaked is repaired.
- When installing, relocating, or servicing the air conditioner, use only the specified refrigerant (R32) to charge the refrigerant lines. Do not mix it with any other refrigerant and do not allow air to remain in the lines.
- Pipe-work shall be protected from physical damage.
- Compliance with national gas regulations shall be observed.

Selection of installation location

- If you install the unit in a small room, take appropriate measures to prevent the refrigerant from exceeding the limit concentration even if it leaks. Consult the dealer from whom you purchased the air conditioner when you implement the measures. Accumulation of highly concentrated refrigerant may cause an oxygen deficiency accident.
- Do not install the air conditioner in a location that may be subject to a risk of exposure to a combustible gas. If a combustible gas leaks and becomes concentrated around the unit, a fire may occur.
- When transporting the air conditioner, wear shoes with additional protective toecap.
- When transporting the air conditioner, do not take hold of the bands around the packing carton. You may injure yourself if the bands should break.
- Do not place any combustion appliance in a place where it is directly exposed to the wind of air conditioner, otherwise it may cause imperfect combustion.
- Do not install the air conditioner in a poorly ventilated space that is smaller than the minimum floor area (A_{min}).
 - This applies to:
 - Indoor units
 - Outdoor units installed (example: winter garden, garage, machinery room, etc.)
 - Refer to “15 APPENDIX - [2] Minimum floor area: A_{min} (m^2)” to determine the minimum floor area.

Installation

- Install the air conditioner at enough strong places to withstand the weight of the unit. If the strength is not enough, the unit may fall down resulting in injury.

- Follow the instructions in the Installation Manual to install the air conditioner. Failure to follow these instructions may cause the product to fall down or topple over or give rise to noise, vibration, water leakage, etc.
- The designated bolts (M10) and nuts (M10) for securing the outdoor unit must be used when installing the unit.
- Install the outdoor unit properly in a location that is durable enough to support the weight of the outdoor unit. Insufficient durability may cause the outdoor unit to fall, which may result in injury.
- If refrigerant gas has leaked during the installation work, ventilate the room immediately. If the leaked refrigerant gas comes in contact with fire, noxious gas may be generated.
- The installation of pipe work shall be kept to a minimum.

Refrigerant piping

- Install the refrigerant pipe securely during the installation work before operating the air conditioner. If the compressor is operated with the valve open and without refrigerant pipe, the compressor sucks air and the refrigeration cycles is over pressurized, which may cause an injury.
- Tighten the flare nut with a torque wrench in the specified manner. Excessive tighten of the flare nut may cause a crack in the flare nut after a long period, which may result in refrigerant leakage.
- For installation and relocation work, follow the instructions in the Installation Manual and use tools and pipe components specifically made for use with R32 refrigerant. If pipe components not designed for R32 refrigerant are used and the unit is not installed correctly, the pipes may burst and cause damage or injuries. In addition, water leakage, electric shock, or fire may result.
- Nitrogen gas must be used for the airtight test.
- The charge hose must be connected in such a way that it is not slack.

Electrical wiring

- Only a qualified installer(*1) or qualified service person(*1) is allowed to carry out the electrical work of the air conditioner. Under no circumstances must this work be done by an unqualified individual since failure to carry out the work properly may result in electric shocks and/or electrical leaks.
- The appliance shall be installed in accordance with national wiring regulations. Capacity shortages of the power circuit or an incomplete installation may cause an electric shock or fire.
- Use wiring that meets the specifications in the Installation Manual and the stipulations in the local regulations and laws. Use of wiring which does not meet the specifications may give rise to electric shocks, electrical leakage, smoking and/or a fire.
- Be sure to connect earth wire. (Grounding work)
Incomplete earthing causes an electric shock.
- Do not connect earth wires to gas pipes, water pipes, and lightning rods or earth wires for telephone wires.
- After completing the repair or relocation work, check that the earth wires are connected properly.
- Install a circuit breaker that meets the specifications in the installation manual and the stipulations in the local regulations and laws.
- Install the circuit breaker where it can be easily accessed by the agent.
- When installing the circuit breaker outdoors, install one which is designed to be used outdoors.
- Under no circumstances must the power cable be extended.
Connection trouble in the places where the cable is extended may give rise to smoking and/or a fire.

Test run

- Before operating the air conditioner after having completed the work, check that the electrical parts box cover of the indoor unit and service panel of the outdoor unit are closed, and set the circuit breaker to the ON position. You may receive an electric shock, etc. if the power is turned on without first conducting these checks.
- When you have noticed that some kind of trouble (such as when a check display has appeared, there is a smell of burning, abnormal sounds are heard, the air conditioner fails to cool or heat or water is leaking) has occurred in the air conditioner, do not touch the air conditioner yourself but set the circuit breaker to the OFF position, and contact a qualified service person. Take steps to ensure that the power will not be turned on (by marking “out of service” near the circuit breaker, for instance) until qualified service person arrives. Continuing to use the air conditioner in the trouble status may cause mechanical problems to escalate or result in electric shocks, etc.
- After the work has finished, be sure to use an insulation tester set (500VMΩ) to check the resistance is 1 MΩ or more between the charge section and the non-charge metal section (Earth section). If the resistance value is low, a disaster such as a leak or electric shock is caused at user’s side.
- Upon completion of the installation work, check for refrigerant leaks and check the insulation resistance and water drainage. Then conduct a test run to check that the air conditioner is operating properly.
- After the installation work, confirm that refrigerant gas does not leak. If refrigerant gas leaks into the room and flows near a fire source, such as a cooking range, noxious gas may be generated.

Explanations given to user

- Upon completion of the installation work, tell the user where the circuit breaker is located. If the user does not know where the circuit breaker is, he or she will not be able to turn it off in the event that trouble has occurred in the air conditioner.
- If you have discovered that the fan guard is damaged, do not approach the outdoor unit but set the circuit breaker to the OFF position, and contact a qualified service person(*1) to have the repairs done. Do not set the circuit breaker to the ON position until the repairs are completed.
- After the installation work, follow the Owner’s Manual to explain to the customer how to use and maintain the unit.

Relocation

- Only a qualified installer(*1) or qualified service person(*1) is allowed to relocate the air conditioner. It is dangerous for the air conditioner to be relocated by an unqualified individual since a fire, electric shocks, injury, water leakage, noise and/or vibration may result.
- When carrying out the pump-down work shut down the compressor before disconnecting the refrigerant pipe. Disconnecting the refrigerant pipe with the service valve left open and the compressor still operating will cause air, etc. to be sucked in, raising the pressure inside the refrigeration cycle to an abnormally high level, and possibly resulting in reputing, injury, etc.

(*1) Refer to the “Definition of Qualified Installer or Qualified Service Person.”

⚠ CAUTION

This air conditioner adopts the HFC refrigerant (R32) which does not destroy the ozone layer

- R32 refrigerant has a high working pressure and is apt to be affected by impurities such as water, oxidizing membrane, and oils. Therefore, during installation work, be careful that water, dust, previous refrigerant, refrigerating machine oil, or other substances do not enter the R32 refrigeration cycle.
- Special tools for R32 or R410A refrigerant are required for installation.
- For connecting pipes, use new and clean piping materials, and make sure that water and/or dust does not enter.

Cautions for outdoor unit installation space

- In the event that the outdoor unit is installed in a small space and refrigerant leaks, accumulation of highly concentrated refrigerant may cause a fire hazard. Therefore, be sure to follow the installation space instructions in the Installation Manual, and provide open space on at least one of the four outdoor unit sides.
- In particular, when both the discharge and intake sides face walls and obstacles are also placed on both sides of the outdoor unit, take steps to provide space wide enough for a person to pass (600 mm or more) on one side to prevent leaked refrigerant from accumulating.

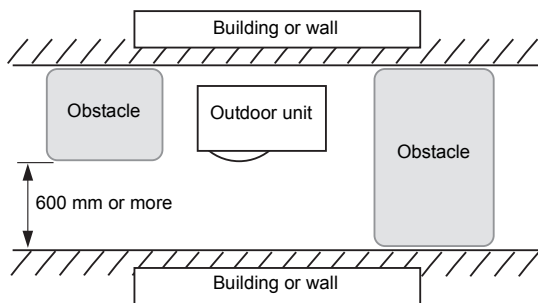

To disconnect the appliance from main power supply

- This appliance must be connected to the main power supply by means of a switch with a contact separation of at least 3 mm.

Do not wash air conditioners with pressure washers.

- Electric leaks may cause electric shocks or fires.

Nous vous remercions de cet achat d'un climatiseur Toshiba.

Veuillez lire attentivement ces instructions contenant des informations importantes concernant la conformité à la « Directive Matériel » (Directive 2006/42/EC) et assurez-vous de les comprendre.

Après avoir lu ces instructions, veuillez à les conserver en lieu sûr avec le Manuel du propriétaire et le Manuel d'installation fournis avec votre produit.

Dénomination générique : Climatiseur

Définition d'un Installateur qualifié ou Technicien d'entretien qualifié

Le climatiseur doit être installé, entretenu, réparé et mis au rebut par un installateur qualifié ou un technicien d'entretien qualifié. Lorsqu'une de ces opérations doit être effectuée, demandez à un installateur qualifié ou un technicien d'entretien qualifié de les exécuter pour vous.

Un installateur qualifié ou technicien d'entretien qualifié est un agent qui a les qualifications et connaissances décrites dans le tableau ci-dessous.

Agent	Qualifications et connaissances que cet agent doit posséder
Installateur qualifié	<ul style="list-style-type: none"> L'installateur qualifié est une personne qui installe, entretient, déplace et met au rebut les climatiseurs fabriqués par Toshiba Carrier Corporation. Il ou elle a été formé pour installer, entretenir, déplacer et mettre au rebut les climatiseurs fabriqués par Toshiba Carrier Corporation, ou, alternativement, il ou elle a été instruit à exécuter de telles opérations par un individu ou des individus qui ont été formés et est ainsi parfaitement au courant des connaissances liées à ces opérations. L'installateur qualifié qui est habilité à effectuer les travaux d'électricité liés à l'installation, le déplacement et la mise au rebut a les qualifications concernant ces travaux d'électricité telles que stipulées par les lois et règlements locaux, et il ou elle est une personne qui a été formée en tout ce qui a trait aux travaux d'électricité sur les climatiseurs fabriqués par Toshiba Carrier Corporation ou, alternativement, il ou elle a été instruit à exécuter ces travaux par un individu ou des individus qui ont été formés et est ainsi parfaitement au courant des connaissances liées à ces travaux. L'installateur qualifié qui est habilité à effectuer la manipulation et les travaux de tuyauterie de réfrigérant liés à l'installation, le déplacement et la mise au rebut a les qualifications concernant cette manipulation et ces travaux de tuyauterie de réfrigérant telles que stipulées par les lois et règlements locaux, et il ou elle est une personne qui a été formée en tout ce qui a trait à la manipulation et aux travaux de tuyauterie de réfrigérant sur les climatiseurs fabriqués par Toshiba Carrier Corporation ou, alternativement, il ou elle a été instruit à exécuter cette manipulation et ces travaux par un individu ou des individus qui ont été formés et est ainsi parfaitement au courant des connaissances liées à ces travaux. L'installateur qualifié qui est habilité à travailler à certaines hauteurs a été formé en tout ce qui a trait au travail en hauteur avec les climatiseurs fabriqués par Toshiba Carrier Corporation ou, alternativement, il ou elle a été instruit à exécuter ce travail par un individu ou des individus qui ont été formés et est ainsi parfaitement au courant des connaissances liées à ce travail.

Technicien d'entretien qualifié	<ul style="list-style-type: none"> Le technicien d'entretien qualifié est une personne qui installe, répare, entretient, déplace et met au rebut les climatiseurs fabriqués par Toshiba Carrier Corporation. Il ou elle a été formé pour installer, réparer, entretenir, déplacer et mettre au rebut les climatiseurs fabriqués par Toshiba Carrier Corporation, ou, alternativement, il ou elle a été instruit à exécuter de telles opérations par un individu ou des individus qui ont été formés et est ainsi parfaitement au courant des connaissances liées à ces opérations. Le technicien d'entretien qualifié qui est habilité à effectuer les travaux d'électricité liés à l'installation, la réparation, le déplacement et la mise au rebut a les qualifications concernant ces travaux d'électricité telles que stipulées par les lois et règlements locaux, et il ou elle est une personne qui a été formée en tout ce qui a trait aux travaux d'électricité sur les climatiseurs fabriqués par Toshiba Carrier Corporation ou, alternativement, il ou elle a été instruit à exécuter ces travaux par un individu ou des individus qui ont été formés et est ainsi parfaitement au courant des connaissances liées à ces travaux. Le technicien d'entretien qualifié qui est habilité à effectuer la manipulation et les travaux de tuyauterie de réfrigérant liés à l'installation, la réparation, le déplacement et la mise au rebut a les qualifications concernant cette manipulation et ces travaux de tuyauterie de réfrigérant telles que stipulées par les lois et règlements locaux, et il ou elle est une personne qui a été formée en tout ce qui a trait à la manipulation et aux travaux de tuyauterie de réfrigérant sur les climatiseurs fabriqués par Toshiba Carrier Corporation ou, alternativement, il ou elle a été instruit à exécuter cette manipulation et ces travaux par un individu ou des individus qui ont été formés et est ainsi parfaitement au courant des connaissances liées à ces travaux. Le technicien d'entretien qualifié qui est habilité à travailler à certaines hauteurs a été formé en tout ce qui a trait au travail en hauteur avec les climatiseurs fabriqués par Toshiba Carrier Corporation ou, alternativement, il ou elle a été instruit à exécuter ce travail par un individu ou des individus qui ont été formés et est ainsi parfaitement au courant des connaissances liées à ce travail.
---------------------------------	--

Définition de l'équipement de protection

Lorsque le climatiseur doit être transporté, installé, entretenu, réparé ou mis au rebut, portez des gants de protection et des vêtements de 'sécurité'.

En plus de cet équipement de protection normal, portez les protections décrites ci-dessous lorsque vous entreprenez les travaux spéciaux indiqués dans le tableau suivant.



Le fait de ne pas porter l'équipement de sécurité correct est dangereux car vous serez plus susceptible d'être blessé, brûlé, de recevoir des décharges électriques et autres blessures.

Travaux entrepris	Equipement de protection porté
Tous types de travaux	Gants de protection Vêtements de sécurité
Travaux liés à l'électricité	Gants pour fournir une protection contre les décharges électriques Chaussures isolantes Vêtements pour fournir une protection contre les décharges électriques
Travaux faits en hauteur (50 cm ou plus)	Casques utilisés dans l'industrie
Transport d'objets lourds	Chaussures avec des bouts renforcés de protection
Réparation de l'unité extérieure	Gants pour fournir une protection contre les décharges électriques

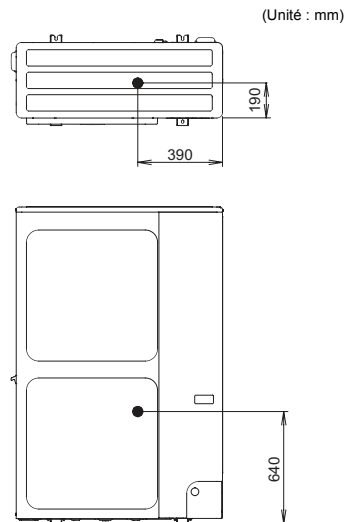
■ Centre de gravité



Ces consignes de sécurité décrivent des sujets importants en matière de sécurité afin de prévenir les blessures des utilisateurs ou d'autres personnes et les dommages matériels. Veuillez lire ce mode d'emploi dans son intégralité après avoir assimilé le contenu ci-dessous (sens des indications) et veillez à suivre la description.





Indication	Sens de l'indication
 AVERTISSEMENT	Le texte introduit de cette manière indique que le non-respect des instructions de l'avertissement peut entraîner des préjudices corporels graves (*1) ou la mort si le produit est manipulé de manière incorrecte.
 ATTENTION	Le texte introduit de cette manière indique que le non-respect des instructions de la précaution peut entraîner des blessures légères (*2) ou des dommages matériels (*3) si le produit est manipulé de manière incorrecte.



*1 : Par préjudices corporels graves, on entend : perte de la vue, blessures, brûlures, électrocution, fracture osseuse, empoisonnement et autres lésions laissant des séquelles et nécessitant une hospitalisation ou un traitement ambulatoire de longue durée.



*2 : Par blessures légères, on entend : blessures, brûlures, électrocution et autres lésions ne nécessitant pas une hospitalisation ni un traitement ambulatoire de longue durée.

*3 : Par dommages matériels, on entend : les dommages touchant les immeubles, les articles ménagers, le bétail domestique et les animaux de compagnie.

■ Indications d'avertissement sur le climatiseur

	AVERTISSEMENT (Risque d'incendie)	Ce symbole concerne uniquement le réfrigérant R32. Le type de réfrigérant est inscrit sur la plaque signalétique de l'unité extérieure. Si le type de réfrigérant est le R32, cet appareil utilise un réfrigérant inflammable. La fuite ou le contact du réfrigérant avec le feu ou une pièce chauffante produira un gaz nocif, ce qui présente un risque d'incendie.
	Lisez attentivement le MANUEL DU PROPRIÉTAIRE avant utilisation.	
	Les techniciens d'entretien sont tenus de lire attentivement le MANUEL DU PROPRIÉTAIRE et le MANUEL D'INSTALLATION avant utilisation.	
	Des informations supplémentaires sont disponibles dans le MANUEL DU PROPRIÉTAIRE, le MANUEL D'INSTALLATION et autres.	

Indication d'avertissement	Description		
 <table border="1"> <tr> <td>WARNING</td> </tr> <tr> <td>ELECTRICAL SHOCK HAZARD Disconnect all remote electric power supplies before servicing.</td> </tr> </table>	WARNING	ELECTRICAL SHOCK HAZARD Disconnect all remote electric power supplies before servicing.	AVERTISSEMENT RISQUE DE DECHARGE ELECTRIQUE Débranchez toutes les alimentations électriques distantes avant l'entretien.
WARNING			
ELECTRICAL SHOCK HAZARD Disconnect all remote electric power supplies before servicing.			
 <table border="1"> <tr> <td>WARNING</td> </tr> <tr> <td>Moving parts. Do not operate unit with grille removed. Stop the unit before the servicing.</td> </tr> </table>	WARNING	Moving parts. Do not operate unit with grille removed. Stop the unit before the servicing.	AVERTISSEMENT Pièces mobiles. Ne faites pas fonctionner l'unité avec la grille déposée. Arrêtez l'unité avant l'entretien.
WARNING			
Moving parts. Do not operate unit with grille removed. Stop the unit before the servicing.			
 <table border="1"> <tr> <td>CAUTION</td> </tr> <tr> <td>High temperature parts. You might get burned when removing this panel.</td> </tr> </table>	CAUTION	High temperature parts. You might get burned when removing this panel.	ATTENTION Pièces à haute température. Vous pourriez vous brûler en déposant ce panneau.
CAUTION			
High temperature parts. You might get burned when removing this panel.			

	CAUTION	ATTENTION Ne touchez pas les ailettes en aluminium de l'unité. Vous pourriez vous blesser.
	Do not touch the aluminum fins of the unit. Doing so may result in injury.	
	CAUTION	ATTENTION RISQUE D'EXPLOSION Ouvrez les soupapes de service avant l'opération, sinon un éclatement pourrait se produire.
	BURST HAZARD Open the service valves before the operation, otherwise there might be the burst.	

1 MESURES DE SECURITE

Le fabricant ne peut être tenu responsable pour tout dommage causé par le non respect des instructions et descriptions de ce manuel.

⚠ AVERTISSEMENT

Généralités

- Avant de commencer à installer le climatiseur, lisez attentivement le Manuel d'installation et suivez ses instructions pour installer le climatiseur.
- Seul un installateur qualifié(*1) ou technicien d'entretien qualifié(*1) est habilité à installer le climatiseur. Si le climatiseur est installé par une personne non qualifiée, il y a un risque d'incendie, de décharges électriques, de blessure, de fuite d'eau, de bruit et/ou de vibrations.
- N'utilisez aucun autre réfrigérant que celui spécifié pour tout rajout ou remplacement. Sinon, une haute pression anormale pourrait être générée dans le circuit de réfrigération, qui pourrait entraîner une panne ou une explosion du produit ou même des blessures corporelles.
- Pour transporter le climatiseur, utilisez un chariot élévateur et pour le déplacer à la main, faites-le avec au moins 4 personnes.
- Avant d'ouvrir la grille de prise d'air de l'unité intérieure ou le panneau de service de l'unité extérieure, réglez le disjoncteur sur la position OFF. Si le disjoncteur n'est pas réglé sur la position OFF, il y a un risque de décharges électriques par contact avec les pièces intérieures. Seul un installateur qualifié(*1) ou technicien d'entretien qualifié(*1) est habilité à déposer la grille de prise d'air de l'unité intérieure ou le panneau de service de l'unité extérieure et à effectuer les travaux requis.

- Avant d'effectuer les travaux d'installation, d'entretien, de réparation ou de mise au rebut, assurez-vous de régler le disjoncteur sur la position OFF. Sinon des décharges électriques peuvent se produire.
- Placez un signe « Travail en cours » près du disjoncteur pendant que les travaux d'installation, d'entretien, de réparation ou de mise au rebut sont effectués. Il y a un risque de décharges électriques si le disjoncteur est réglé sur ON par mégarde.
- Seul un installateur qualifié(*1) ou une personne d'entretien qualifiée(*1) est autorisé à entreprendre un travail en hauteur à l'aide d'un pied de 50 cm minimum.
- Portez des gants de protection et des vêtements de sécurité pendant l'installation, l'entretien et la mise au rebut.
- Ne touchez pas l'ailette en aluminium de l'unité extérieure. Vous pourriez vous blesser si vous le faites. Si l'ailette doit être touchée pour une raison quelconque, mettez tout d'abord des gants de protection et des vêtements de sécurité, puis procédez au travail.
- Ne montez pas ni ne placez d'objets sur le haut de l'unité extérieure. Vous pourriez chuter ou les objets tomber du haut de l'unité extérieure et vous blesser.
- Pour travailler en hauteur, utilisez une échelle conforme à la norme ISO 14122 et suivez la procédure indiquée dans les instructions de l'échelle. Portez aussi un casque utilisé dans l'industrie comme équipement de protection pour entreprendre les travaux.
- Pour travailler en hauteur, placez un signe de sorte que personne n'approchera de cet emplacement avant de procéder aux travaux. Des pièces et autres objets peuvent tomber d'en haut, d'où la possibilité de blesser une personne se trouvant dessous.
- Vous assurerez le transport du climatiseur en condition stable. Si un élément du produit est cassé, prenez contact avec le revendeur.

- Ne modifiez pas les pièces. De même, ne démontez pas ou ne modifiez pas les pièces. Cela pourrait provoquer un incendie, un choc électrique ou des blessures.
- Cet appareil est conçu pour être utilisé par des experts ou des utilisateurs formés dans des magasins, dans l'industrie légère ou dans le cadre d'une utilisation commerciale par des personnes non initiées.

À propos du réfrigérant

- Ce produit contient des gaz à effet de serre fluorés.
- Ne libérez pas les gaz dans l'atmosphère.
- L'appareil doit être rangé dans une pièce sans source de combustion fonctionnant en continu (par exemple, flammes nues, appareil à gaz fonctionnant ou chauffage électrique fonctionnant).
- Ne percez ni ne brûlez les pièces du circuit du réfrigérant.
- N'utilisez pas de moyens autres que ceux recommandés par le fabricant pour accélérer le processus de dégivrage ou pour le nettoyage.
- Sachez que les réfrigérants peuvent ne pas avoir une odeur.
- Le réfrigérant à l'intérieur de l'appareil est inflammable. En cas de fuite du réfrigérant dans la pièce ou s'il entre en contact avec le feu d'un brûleur, un chauffage ou une cuisinière, un incendie peut se déclencher ou des gaz nocifs peuvent être dégagés.
- Éteignez tout appareil de chauffage à combustion, aérez la pièce et contactez le revendeur auprès duquel vous avez acheté l'appareil.
- N'utilisez pas l'appareil tant qu'un technicien d'entretien n'a pas confirmé que la zone depuis laquelle le réfrigérant s'échappe est réparée.
- Lors de l'installation, le déplacement ou le dépannage du climatiseur, utilisez uniquement le réfrigérant spécifié (R32) pour charger les conduits de réfrigérant. Ne le mélangez pas à d'autres réfrigérants et ne laissez pas d'air rester dans les conduits.
- Les canalisations doivent être protégées des dommages physiques.

- La conformité avec les réglementations nationales en matière de gaz doit être respectée.

Sélection de l'emplacement d'installation

- Si vous installez l'unité dans une petite pièce, prenez des mesures adéquates afin d'éviter que le réfrigérant n'excède la concentration limite, même s'il fuit. Consultez le distributeur chez qui vous avez acheté le climatiseur lorsque vous mettez ces mesures en œuvre. Une accumulation de réfrigérant hautement concentré peut provoquer un accident par manque d'oxygène.
- N'installez pas le climatiseur dans un endroit qui peut être soumis à un risque d'exposition à un gaz combustible. Un incendie peut se produire si un gaz combustible fuit et se concentre autour de l'unité.
- Pour transporter le climatiseur, portez des chaussures avec des bouts renforcés de protection.
- Pour transporter le climatiseur, ne saisissez pas les bandes autour du carton d'emballage. Vous pourriez vous blesser si les bandes se cassent.
- Ne placez aucun appareil à combustion dans un endroit où il est directement exposé à l'air du climatiseur, sinon cela pourrait provoquer une combustion imparfaite.
- N'installez pas le climatiseur dans un endroit mal aéré plus petit que la surface au sol minimum (A_{min}).
Cela concerne :
 - Les unités intérieures
 - Les unités extérieures installées
(exemples : jardin d'hiver, garage, salle des machines, etc.)
 Reportez-vous à « 15 ANNEXE - [2] Surface au sol minimum : A_{min} (m²) » pour déterminer la surface au sol minimum.

Installation

- Installez le climatiseur dans un endroit assez solide pour supporter le poids de l'unité. Si la résistance est insuffisante, l'unité peut tomber et provoquer des blessures.
- Suivez les instructions du Manuel d'installation pour installer le climatiseur. Si ces instructions ne sont pas suivies, le produit peut tomber, se renverser ou engendrer du bruit, des vibrations, une fuite d'eau, etc.
- Les boulons (M10) et écrous (M10) spécifiés pour fixer l'unité extérieure doivent être utilisés lors de l'installation de l'unité.
- Installez correctement l'unité extérieure dans un endroit assez solide pour supporter son poids. L'unité extérieure peut tomber, d'où un risque de blessure, si la résistance est insuffisante.
- Si le gaz frigorigène a fui durant l'installation, aérez immédiatement la pièce. Si le gaz frigorigène qui a fui entre en contact avec une flamme nue, un gaz nocif peut se dégager.
- L'installation de la canalisation doit se limiter au minimum.

Tuyauterie de réfrigérant

- Installez solidement le tuyau de réfrigérant pendant les travaux d'installation avant d'utiliser le climatiseur. Si le compresseur fonctionne avec la soupape ouverte et sans tuyau de réfrigérant, le compresseur aspire de l'air et le cycle de réfrigération est surpressurisé, ce qui peut provoquer une blessure.
- Serrez l'écrou évasé avec une clé dynamométrique de la manière spécifiée. Un serrage excessif de l'écrou évasé peut provoquer, à long terme, une fissure de l'écrou évasé, ce qui peut entraîner une fuite de réfrigérant.

- Pour l'installation et le déplacement, suivez les instructions du manuel d'installation et utilisez les outils et les éléments de tuyauterie spécifiquement conçus pour être utilisés avec le réfrigérant R32. Si des éléments de tuyauterie non conçus pour le réfrigérant R32 sont utilisés et que l'appareil est mal installé, les tuyaux peuvent exploser et entraîner des dommages matériels ou corporels. De plus, il peut en résulter une fuite d'eau, une électrocution ou un incendie.
- Du gaz azote doit être utilisé pour l'essai d'étanchéité.
- Le flexible de charge doit être branché de sorte qu'il n'y ait pas de jeu.

Câblage électrique

- Seul un installateur qualifié(*1) ou technicien d'entretien qualifié(*1) est habilité à effectuer les travaux d'électricité du climatiseur. Ces travaux ne doivent, en aucun cas, être effectués par une personne non qualifiée car si ces travaux ne sont pas exécutés correctement, il y a un risque de décharge électrique et/ou de fuites électriques.
- L'appareil doit être installé conformément aux réglementations de câblage nationales. Un manque de puissance du circuit d'alimentation ou une installation incomplète peut provoquer une décharge électrique ou un incendie.
- Utilisez un câblage conforme aux spécifications du Manuel d'installation et aux stipulations des lois et règlements locaux. L'utilisation d'un câblage qui n'est pas conforme aux spécifications peut engendrer des décharges électriques, une fuite électrique, de la fumée et/ou un incendie.
- Assurez-vous de raccorder le fil de terre. (travaux de mise à la terre) Une mise à la terre incomplète entraîne une décharge électrique.
- Ne raccordez pas des fils de terre à des conduites de gaz, des conduites d'eau, des tiges de paratonnerre ou des fils de terre pour câbles téléphoniques.

- Après avoir terminé les travaux de réparation ou de déplacement, vérifiez que les fils de terre sont correctement raccordés.
- Installez un disjoncteur conforme aux spécifications du Manuel d'installation et aux stipulations des lois et règlements locaux.
- Installez le disjoncteur dans un endroit où l'agent peut facilement y accéder.
- Lors de l'installation du disjoncteur à l'extérieur, installez-en un qui est conçu pour être utilisé dehors.
- Le câble d'alimentation ne doit en aucun cas être prolongé. Un problème de connexion aux points où le câble est prolongé peut engendrer de la fumée et/ou un incendie.

Essai de fonctionnement

- Avant de faire fonctionner le climatiseur après avoir terminé les travaux, vérifiez que le couvercle du boîtier des pièces électriques de l'unité intérieure et le panneau de service de l'unité extérieure sont fermés et réglez le disjoncteur sur la position ON. Vous pouvez recevoir un choc électrique, etc. si l'alimentation est activée sans avoir d'abord effectué ces vérifications.
- Si vous avez remarqué qu'un quelconque problème (comme lorsque l'affichage de contrôle est apparu, une odeur de brûlé survient, des sons anormaux sont entendus, le climatiseur ne parvient pas à refroidir ou à réchauffer ou une fuite d'eau est présente) est survenu au niveau du climatiseur, ne touchez pas le climatiseur vous-même et réglez le disjoncteur sur la position Arrêt, ensuite, contactez une personne d'entretien qualifiée. Prenez des mesures pour être sûr que l'alimentation ne sera pas activée (en plaçant un signe « hors service » près du disjoncteur, par exemple) jusqu'à ce qu'un technicien d'entretien qualifié arrive. Continuer à utiliser le climatiseur en état anormal peut faire que les problèmes mécaniques s'accroissent ou provoquer des décharges électriques, etc.

- Après avoir terminé les travaux, assurez-vous d'utiliser un appareil d'essai d'isolement (500 VMΩ) pour vérifier que la résistance est de 1 MΩ ou plus entre la section de charge et la section métallique de non charge (section terre). Si la valeur de résistance est faible, un sinistre comme une fuite ou une décharge électrique est provoqué au côté utilisateur.
- Après avoir terminé les travaux d'installation, vérifiez qu'il n'y a pas de fuites de réfrigérant et contrôlez la résistance d'isolement et l'évacuation d'eau. Puis effectuez un essai de fonctionnement pour vérifier que le climatiseur fonctionne correctement.
- Après l'installation, assurez-vous que le gaz réfrigérant ne fuit pas. Si le gaz réfrigérant fuit dans la pièce et s'écoule à proximité d'une source inflammable, telle qu'une cuisinière, un gaz nocif peut se dégager.

Explications données à l'utilisateur

- Après avoir terminé les travaux d'installation, indiquez à l'utilisateur où le disjoncteur est situé. Si l'utilisateur ne sait pas où est le disjoncteur, il ou elle ne pourra pas le mettre hors tension au cas où un problème se produit dans le climatiseur.
- Si vous avez découvert que la protection du ventilateur est endommagée, n'approchez pas de l'unité extérieure et réglez le coupe-circuit en position Arrêt, ensuite, contactez une personne d'entretien qualifiée(*1) afin d'effectuer les réparations. Ne réglez pas le disjoncteur en position ON avant que les réparations soient terminées.
- Après les travaux d'installation, suivez le Manuel du propriétaire pour expliquer au client comment utiliser et entretenir l'unité.

Déplacement

- Seul un installateur qualifié(*1) ou technicien d'entretien qualifié(*1) est habilité à déplacer le climatiseur. Le déplacement du climatiseur par une personne non qualifiée est dangereux, car cela peut entraîner un incendie, des décharges électriques, une blessure, une fuite d'eau, du bruit et/ou des vibrations.
- Pour effectuer les travaux de pompage, arrêtez le compresseur avant de déconnecter le tuyau de réfrigérant. La déconnexion du tuyau de réfrigérant alors que la soupape de service est restée ouverte et que le compresseur fonctionne encore provoquera une aspiration d'air, etc., ce qui augmente la pression dans le cycle de réfrigération à un niveau anormalement élevé, d'où la possibilité d'une rupture, d'une blessure, etc.

(*1) Reportez-vous à la « Définition d'un Installateur qualifié ou Technicien d'entretien qualifié ».

⚠ ATTENTION

Ce climatiseur utilise le réfrigérant HFC (R32) qui ne détruit pas la couche d'ozone

- Le réfrigérant R32 a une pression de service élevée et peut être affecté par des impuretés comme l'eau, la membrane oxydante et les huiles. Par conséquent, durant l'installation, assurez-vous que l'eau, la poussière, le réfrigérant précédent, l'huile pour machine frigorifique ou d'autres substances n'entrent pas dans le circuit de réfrigération du R32.
- Des outils spéciaux pour le réfrigérant R32 ou R410A sont nécessaires pour l'installation.
- Quant aux tuyaux de raccordement, utilisez des matériaux de tuyauterie neufs et propres et veillez à ce que l'eau et/ou la poussière n'y entrent pas.

Précautions relatives à l'espace d'installation de l'unité extérieure

- Si l'unité extérieure est installée dans un espace restreint et que le réfrigérant fuit, l'accumulation de réfrigérant hautement concentré peut présenter un risque d'incendie. Par conséquent, veillez à suivre les instructions concernant l'espace d'installation dans le manuel d'installation et prévoyez un espace ouvert sur au moins un des quatre côtés de l'unité extérieure.
- En particulier, lorsque les côtés de décharge et d'entrée sont tous deux tournés vers le mur et que des obstacles sont également placés des deux côtés de l'unité extérieure, prévoyez un espace assez large pour qu'une personne puisse passer (600 mm ou plus) d'un côté pour empêcher l'accumulation du réfrigérant qui a fui.

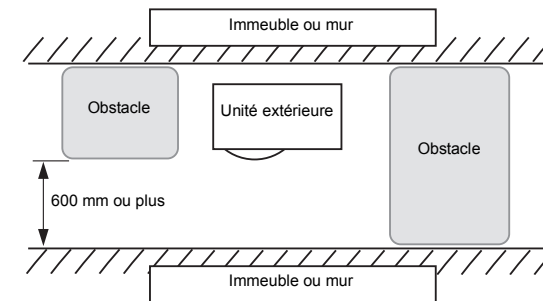

Pour déconnecter l'appareil du secteur

- Cet appareil doit être connecté au secteur via un interrupteur ayant une séparation de contact d'au moins 3 mm.
- Ne nettoyez pas les climatiseurs à l'aide d'un nettoyeur à pression.**
- Les fuites de courant électrique peuvent entraîner une électrocution ou un incendie.

Vielen Dank, dass Sie diese Klimaanlage von Toshiba erworben haben.
 Lesen Sie diese Anweisungen einschließlich der wichtigen Informationen, die der Maschinenrichtlinie 2006/42/EG entsprechen, sorgfältig durch, und stellen Sie sicher, dass Sie sie verstanden haben.
 Nachdem Sie diese Anweisungen gelesen haben, bewahren Sie sie unbedingt an einem sicheren Ort zusammen mit dem Benutzerhandbuch und dem Ihrem Produkt beiliegenden Installationshandbuch auf.

Allgemeine Bezeichnung: Klimaanlage

Definition der Bezeichnungen „Qualifizierter Installateur“ oder „Qualifizierter Servicetechniker“

Die Klimaanlage muss von einem qualifizierten Installateur oder einem qualifizierten Servicetechniker installiert, gewartet, repariert und entsorgt werden. Wenn eine dieser Aufgaben erledigt werden muss, bitten Sie einen qualifizierten Installateur oder einen qualifizierten Servicetechniker, diese für Sie auszuführen.
 Ein qualifizierter Installateur oder ein qualifizierter Servicetechniker ist ein Auftragnehmer, der über die Qualifikationen und das Fachwissen verfügt, welche in der untenstehenden Tabelle genannt sind.

Auftragnehmer	Qualifikationen und Fachwissen, über welche der Auftragnehmer verfügen muss
Qualifizierter Installateur	<ul style="list-style-type: none"> Der qualifizierte Installateur ist ein Auftragnehmer, der die von der Toshiba Carrier Corporation hergestellten Klimaanlagen installiert, wartet, umsetzt und entsorgt. Dieser Auftragnehmer wurde speziell geschult, die von der Toshiba Carrier Corporation hergestellten Klimaanlagen zu installieren, zu warten, umzusetzen und zu entsorgen. Alternativ kann diese Person bezüglich dieser Aufgaben von einem oder mehreren Mitarbeitern instruiert worden sein, welche eine spezifische Schulung absolviert haben. Somit ist der Auftragnehmer mit dem für diese Aufgaben erforderlichen Wissen bestens vertraut. Der qualifizierte Installateur, der die für Installation, Umsetzung und Entsorgung erforderlichen Elektroarbeiten ausführen darf, verfügt über die für diese Elektroarbeiten erforderlichen Qualifikationen im Einklang mit den lokalen Gesetzen und Rechtsvorschriften. Er wurde speziell geschult, Elektroarbeiten an den von der Toshiba Carrier Corporation hergestellten Klimaanlagen auszuführen. Alternativ kann diese Person bezüglich dieser Arbeiten von einem oder mehreren Mitarbeitern instruiert worden sein, welche eine derartige Schulung absolviert haben, und ist somit mit dem für diese Aufgaben erforderlichen Wissen bestens vertraut. Der qualifizierte Installateur, der die für Installation, Umsetzung und Entsorgung erforderlichen Kältemittelhandhabungs- und Rohrleitungsarbeiten ausführen darf, verfügt über die für diese Arbeiten erforderlichen Qualifikationen im Einklang mit den lokalen Gesetzen und Rechtsvorschriften. Er wurde speziell geschult, Kältemittelhandhabungs- und Rohrleitungsarbeiten an den von der Toshiba Carrier Corporation hergestellten Klimaanlagen auszuführen. Alternativ kann diese Person bezüglich dieser Arbeiten von einem oder mehreren Mitarbeitern instruiert worden sein, welche eine derartige Schulung absolviert haben, und ist somit mit dem für diese Aufgaben erforderlichen Wissen bestens vertraut. Der qualifizierte Installateur, der über eine Erlaubnis für Höhenarbeiten verfügt, wurde speziell geschult, Arbeiten an von der Toshiba Carrier Corporation hergestellten Klimaanlagen an hochgelegenen Arbeitsplätzen auszuführen. Alternativ kann diese Person bezüglich dieser Arbeiten von einem oder mehreren auf diesem Gebiet geschulten Mitarbeitern instruiert worden sein und ist somit mit dem für diese Arbeiten erforderlichen Wissen bestens vertraut.

Qualifizierter Servicetechniker	<ul style="list-style-type: none"> Der qualifizierte Servicetechniker ist ein Auftragnehmer, der die von der Toshiba Carrier Corporation hergestellten Klimaanlagen installiert, repariert, wartet, umsetzt und entsorgt. Dieser Auftragnehmer wurde speziell geschult, die von der Toshiba Carrier Corporation hergestellten Klimaanlagen zu installieren, reparieren, warten, umzusetzen und zu entsorgen. Alternativ kann diese Person bezüglich dieser Aufgaben von einem oder mehreren Mitarbeitern instruiert worden sein, welche eine spezifische Schulung absolviert haben. Somit ist der Auftragnehmer mit dem für diese Aufgaben erforderlichen Wissen bestens vertraut. Der qualifizierte Servicetechniker, der die für Installation, Reparatur, Umsetzung und E ntsorgung erforderlichen Elektroarbeiten ausführen darf, verfügt über die für diese E lektrarbeiten erforderlichen Qualifikationen im Einklang mit den lokalen Gesetzen und Rechtsvorschriften. Er wurde speziell geschult, Elektroarbeiten an den von der Toshiba Carrier Corporation hergestellten Klimaanlagen auszuführen. Alternativ kann diese Person bezüglich dieser Arbeiten von einem oder mehreren Mitarbeitern instruiert worden sein, welche eine derartige Schulung absolviert haben, und ist somit mit dem für diese Aufgaben erforderlichen Wissen bestens vertraut. Der qualifizierte Servicetechniker, der die für Installation, Reparatur, Umsetzung und E ntsorgung erforderlichen Kältemittelhandhabungs- und Rohrleitungsarbeiten ausführen darf, verfügt über die für diese Arbeiten erforderlichen Qualifikationen im Einklang mit den lokalen Gesetzen und Rechtsvorschriften. Er wurde speziell geschult, Kältemittelhandhabungs- und Rohrleitungsarbeiten an den von der Toshiba Carrier Corporation hergestellten Klimaanlagen auszuführen. Alternativ kann diese Person bezüglich dieser Arbeiten von einem oder mehreren Mitarbeitern instruiert worden sein, welche eine derartige Schulung absolviert haben, und ist somit mit dem für diese Aufgaben erforderlichen Wissen bestens vertraut. Der qualifizierte Servicetechniker, der über eine Erlaubnis für Höhenarbeiten verfügt, wurde speziell geschult, Arbeiten an den von der Toshiba Carrier Corporation hergestellten Klimaanlagen an hochgelegenen Arbeitsplätzen auszuführen. Alternativ kann diese Person bezüglich dieser Arbeiten von einem oder mehreren auf diesem Gebiet geschulten Mitarbeitern instruiert worden sein und ist somit mit dem für diese Arbeiten erforderlichen Wissen bestens vertraut.
---------------------------------	--

Definitionen zur Schutzkleidung

Wenn die Klimaanlage transportiert, installiert, gewartet, repariert oder entsorgt werden soll, tragen Sie Schutzhandschuhe und Arbeitsschutzbekleidung.

Tragen Sie zusätzlich zu dieser normalen Schutzkleidung die unten aufgeführte Schutzkleidung, wenn Sie die in der unteren Tabelle genannten Spezialarbeiten ausführen.

Wenn Sie nicht die geeignete Schutzkleidung tragen, setzen Sie sich erhöhten Gefahren aus, da Sie sich eher Verletzungen, Verbrennungen, Stromschläge u. a. zuziehen.

Arbeitsaufgabe	Zu tragende Schutzkleidung
Alle Arten von Arbeiten	Schutzhandschuhe Arbeitsschutzbekleidung
Elektroarbeiten	Handschuhe zum Schutz vor Stromschlägen Isolierendes Schuhwerk Kleidung zum Schutz vor Stromschlägen
Höhenarbeiten (in einer Höhe von 50 cm oder mehr)	Industrie-Schutzhelme
Transport schwerer Gegenstände	Schuhe mit zusätzlichen Zehenschutzkappen
Reparatur des Außengeräts	Handschuhe zum Schutz vor Stromschlägen

■ Schwerpunkt

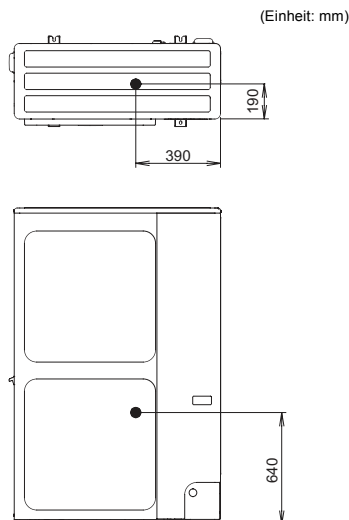







Diese Sicherheitshinweise beschreiben wichtige Sicherheitsaspekte, um Verletzungen bei Benutzern oder anderen Personen sowie Sachschäden zu vermeiden. Bitte lesen Sie diese Anleitung sorgfältig durch, nachdem Sie die folgenden Inhalte (Bedeutung der Hinweise) verstanden haben, und befolgen Sie unbedingt die Beschreibung.

Hinweis	Bedeutung der Hinweise
WARNUNG	Ein auf diese Weise gekennzeichnete Text weist darauf hin, dass die Nichtbeachtung der Warnhinweise bei unsachgemäßer Handhabung zu schweren Körperverletzungen (*1) oder zum Verlust von Menschenleben führen kann.
VORSICHT	Ein auf diese Weise gekennzeichnete Text weist darauf hin, dass die Nichtbeachtung der Vorsichtshinweise bei der unsachgemäßen Handhabung des Produkts zu leichten Verletzungen (*2) oder Sachschäden (*3) führen kann.

- *1: „Schwere Körperverletzungen“ umfassen den Verlust der Sehkraft, Verletzungen, Verbrennungen, Stromschläge, Knochenbrüche, Vergiftungen oder andere Verletzungen, die eine Folgeerscheinung hinterlassen und einen Krankenhausaufenthalt oder eine langfristige ambulante Behandlung erfordern.
- *2: „Leichte Verletzungen“ umfassen Verletzungen, Verbrennungen, Stromschläge und andere Verletzungen, die keinen Krankenhausaufenthalt bzw. keine langfristige ambulante Behandlung erfordern.
- *3: „Sachschäden“ umfassen Schäden an Gebäuden, Hausrat, Nutztieren und Haustieren.

■ Warnanzeigen an der Klimaanlage

	WARNUNG (Brandgefahr)	Diese Kennzeichnung gilt nur für das Kältemittel R32. Der Kältemitteltyp ist auf dem Typenschild des Außengerätes angegeben. Wenn der Kältemitteltyp R32 ist, wird in diesem Gerät ein brennbares Kältemittel eingesetzt. Wenn Kältemittel austritt und mit Feuer oder Heizungskomponenten in Berührung kommt, entsteht ein gefährliches Gas, und es besteht Brandgefahr.
		Lesen Sie vor der Inbetriebnahme das BENUTZERHANDBUCH sorgfältig durch.
		Das Servicepersonal muss vor der Inbetriebnahme sowohl das BENUTZERHANDBUCH als auch das INSTALLATIONSHANDBUCH sorgfältig durchlesen.
		Weitere Informationen finden Sie im BENUTZERHANDBUCH, INSTALLATIONSHANDBUCH und in anderen Quellen.

Warnanzeige	Beschreibung		
 <table border="1"> <tr> <td>WARNING</td> </tr> <tr> <td>ELECTRICAL SHOCK HAZARD Disconnect all remote electric power supplies before servicing.</td> </tr> </table>	WARNING	ELECTRICAL SHOCK HAZARD Disconnect all remote electric power supplies before servicing.	WARNUNG GEFAHR EINES ELEKTRISCHEN SCHLAGS Trennen Sie alle fernen Stromversorgungsquellen vom Netz, bevor Sie Wartungsarbeiten ausführen.
WARNING			
ELECTRICAL SHOCK HAZARD Disconnect all remote electric power supplies before servicing.			
 <table border="1"> <tr> <td>WARNING</td> </tr> <tr> <td>Moving parts. Do not operate unit with grille removed. Stop the unit before the servicing.</td> </tr> </table>	WARNING	Moving parts. Do not operate unit with grille removed. Stop the unit before the servicing.	WARNUNG Bewegliche Teile. Bedienen Sie nicht das Gerät, wenn das Gitter entfernt wurde. Stoppen Sie das Gerät, bevor Sie es warten.
WARNING			
Moving parts. Do not operate unit with grille removed. Stop the unit before the servicing.			
 <table border="1"> <tr> <td>CAUTION</td> </tr> <tr> <td>High temperature parts. You might get burned when removing this panel.</td> </tr> </table>	CAUTION	High temperature parts. You might get burned when removing this panel.	VORSICHT Teile mit hohen Temperaturen. Es besteht die Gefahr, dass Sie sich verbrennen, wenn Sie diese Abdeckung entfernen.
CAUTION			
High temperature parts. You might get burned when removing this panel.			

 <table border="1"> <tr> <td>CAUTION</td> </tr> <tr> <td>Do not touch the aluminum fins of the unit. Doing so may result in injury.</td> </tr> </table>	CAUTION	Do not touch the aluminum fins of the unit. Doing so may result in injury.	VORSICHT Berühren Sie nicht die Aluminiumrippen des Geräts. Dies kann zu Verletzungen führen.
CAUTION			
Do not touch the aluminum fins of the unit. Doing so may result in injury.			
 <table border="1"> <tr> <td>CAUTION</td> </tr> <tr> <td>BURST HAZARD Open the service valves before the operation, otherwise there might be the burst.</td> </tr> </table>	CAUTION	BURST HAZARD Open the service valves before the operation, otherwise there might be the burst.	VORSICHT EXPLOSIONSGEFAHR! Öffnen Sie vor dem Arbeitsgang die Versorgungsventile, da es anderenfalls zu einer Explosion kommen kann.
CAUTION			
BURST HAZARD Open the service valves before the operation, otherwise there might be the burst.			

1 SICHERHEITSMASSNAHMEN

Der Hersteller übernimmt keine Haftung für die Schäden, die durch Nichtbeachtung der Beschreibung in dieser Bedienungsanleitung verursacht werden.

⚠️ WARNUNG

Allgemeines

- Bevor Sie mit der Installation der Klimaanlage beginnen, lesen Sie das Installationshandbuch sorgfältig durch, und befolgen Sie dessen Anweisungen zum Installieren der Klimaanlage.
- Nur ein qualifizierter Installateur(*1) oder ein qualifizierter Servicetechniker(*1) darf die Klimaanlage installieren. Bei Installation der Klimaanlage durch einen nicht dafür qualifizierten Benutzer kann es zu Bränden, elektrischen Schlägen, Verletzungen, Wasseraustritten, Geräuschen und/oder Vibrationen kommen.
- Verwenden Sie kein anderes als das vorgeschriebene Kältemittel zum Nachfüllen oder Ersetzen. Andernfalls kann anormal hoher Druck im Kühlkreislauf erzeugt werden, was zu einem Versagen oder einer Explosion des Produkts oder Verletzungen führen kann.
- Verwenden Sie für den Transport des Klimageräts einen Gabelstapler und bewegen Sie das Klimagerät beim Umstellen mit mindestens 4 Personen.
- Bevor Sie das Einlassgitter des Innengerätes oder das Wartungspaneel des Außengeräts öffnen, stellen Sie den Schutzschalter auf die Position OFF (aus). Sollten Sie diesen Hinweis nicht beachten, kann es durch Kontakt mit den Innenteilen zu einem Stromschlag kommen. Nur ein qualifizierter Installateur(*1) oder ein qualifizierter Servicetechniker(*1) darf das Einlassgitter des Innengeräts oder das Wartungspaneel des Außengeräts entfernen und die erforderlichen Arbeiten ausführen.
- Bevor Installations-, Wartungs-, Reparatur- oder Entsorgungsarbeiten ausgeführt werden, stellen Sie unbedingt den Schutzschalter auf die Position OFF (aus). Anderenfalls kann es zu elektrischen Schlägen kommen.

- Befestigen Sie ein Schild „Arbeiten in Ausführung“ neben dem Schutzschalter, während die Installations-, Wartungs-, Reparatur- oder Entsorgungsarbeiten ausgeführt werden. Es besteht die Gefahr von Stromschlägen, wenn der Schutzschalter aus Versehen auf ON (ein) gestellt wird.
- Nur ein qualifizierter Installateur(*1) oder ein qualifizierter Servicetechniker(*1) darf Arbeiten in der Höhe unter Verwendung eines Gerüsts mit einer Höhe von 50 cm oder mehr ausführen.
- Tragen Sie bei Installation, Wartung und Entsorgung Schutzhandschuhe und Arbeitsschutzbekleidung.
- Berühren Sie nicht die Aluminiumrippen des Außengeräts. Anderenfalls können Sie sich verletzen. Wenn die Rippen aus einem bestimmten Grund berührt werden muss, ziehen Sie zuerst Schutzhandschuhe und Arbeitsschutzbekleidung an, bevor Sie diese Arbeiten ausführen.
- Klettern Sie nicht auf das Außengerät, und stellen Sie keine Gegenstände darauf ab. Anderenfalls können Sie abstürzen, oder Gegenstände können vom Außengerät herabfallen. In beiden Fällen besteht Verletzungsgefahr.
- Wenn Sie Höhenarbeiten ausführen, verwenden Sie eine Leiter gemäß ISO-Norm 14122, und befolgen Sie das in der Anleitung der Leiter aufgeführte Verfahren. Tragen Sie als Schutzkleidung beim Ausführen der Arbeiten außerdem einen Industrie-Schutzhelm.
- Bevor Sie Höhenarbeiten ausführen, stellen Sie ein Warnschild auf, damit sich niemand dem Arbeitsbereich nähert. Teile und andere Gegenstände können von oben herunterfallen und u. U. unten befindliche Personen verletzen.
- Sie müssen sicherstellen, dass die Klimaanlage unter stabilen Bedingungen transportiert wird. Wenn Teile des Produkts defekt sind, wenden Sie sich an den Händler.
- Nehmen Sie keine Veränderungen an den Produkten vor. Verändern oder bauen Sie keine Teile auseinander. Dies kann zu Bränden, Stromschlägen oder Verletzungen führen.
- Dieses Gerät ist für die Nutzung durch einem Experten oder geschulte Anwender in Geschäften, in der leichten Industrie oder für Laien bei der gewerblichen Nutzung bestimmt.

Über das Kältemittel

- Dieses Produkt enthält fluorierte Treibhausgase.
- Gase nicht in die Atmosphäre entlassen.
- Das Gerät muss in einem Raum ohne kontinuierlich arbeitende Zündquellen (z. B. offene Flammen, in Betrieb befindliche Gasthermen oder Elektroheizungen) gelagert werden.
- Keine Teile des Kältemittelkreislaufs durchstechen, durchbohren oder verbrennen.
- Verwenden Sie keine anderen als die vom Hersteller empfohlenen Mittel zur Beschleunigung des Abtauvorgangs oder zur Reinigung.
- Beachten Sie, dass Kältemittel möglicherweise geruchlos sind.
- Das Kältemittel im Inneren des Gerätes ist brennbar. Wenn das Kältemittel im Raum austritt und mit dem Feuer eines Brenners, einer Heizung oder eines Herdes in Berührung kommt, kann es zu einem Brand oder zur Bildung von gefährlichen Gasen kommen.
- Schalten Sie alle entflammaren Heizgeräte aus, lüften Sie den Raum und wenden Sie sich an den Händler, bei dem Sie das Gerät gekauft haben.
- Nehmen Sie das Gerät erst dann wieder in Betrieb, wenn ein Servicetechniker bestätigt, dass der Teil, aus dem das Kältemittel ausgetreten ist, repariert ist.
- Verwenden Sie bei der Installation, Verlegung oder Wartung der Klimaanlage nur das angegebene Kältemittel (R32), um die Kältemittelleitungen zu befüllen. Mischen Sie es nicht mit anderen Kältemitteln, und lassen Sie keine Luft in den Leitungen zurück.
- Die Rohrleitungen müssen vor physischen Beschädigungen geschützt werden.
- Die nationalen Vorschriften für den Umgang mit Gas müssen eingehalten werden.

Auswahl des Installationsortes

- Wenn Sie die Anlage in einem kleinen Raum installieren, ergreifen Sie angemessene Vorsichtsmaßnahmen, damit die Kühlmittelkonzentration auch bei Kühlmittelaustritt den Sicherheitsgrenzwert nicht überschreitet. Wenden Sie sich bei Fragen zur Umsetzung der Maßnahmen an den Händler, bei dem Sie die Klimaanlage gekauft haben. Durch Ansammlung von hochkonzentriertem Kühlmittel kann es zu einem Unfall durch Sauerstoffmangel kommen.
- Installieren Sie die Klimaanlage nicht an Orten, an denen die Gefahr besteht, dass sie brennbaren Gasen ausgesetzt ist. Wenn das brennbare Gas ausströmt und sich im Bereich des Geräts sammelt, kann es sich entzünden.
- Tragen Sie beim Transportieren der Klimaanlage Schuhe mit zusätzlichen Zehenschutzkappen.
- Halten Sie die Klimaanlage beim Tragen nicht an den Bändern des Verpackungskartons fest. Anderenfalls können Sie sich verletzen, wenn die Bänder reißen.
- Stellen Sie keine Verbrennungsvorrichtung an Orten auf, wo sie direkt dem Wind der Klimaanlage ausgesetzt ist, da anderenfalls eine unvollständige Verbrennung die Folge ist.
- Installieren Sie die Klimaanlage nicht in einem schlecht belüfteten Raum, dessen Größe die minimale Grundfläche (A_{min}) unterschreitet. Dies gilt für:
 - Innengeräte
 - Installierte Außengeräte (Beispiel: Wintergarten, Garage, Maschinenraum, usw.)Zur Bestimmung der minimalen Grundfläche lesen Sie „15 ANHANG – [2] Minimale Grundfläche: A_{min} (m^2)“.

Installation

- Montieren Sie die Klimaanlage an einem Ort, an dem der Boden das Gewicht des Geräts tragen kann. Ist der Boden nicht widerstandsfähig genug, kann das Gerät umkippen und Verletzungen verursachen.
- Installieren Sie die Klimaanlage entsprechend den Anweisungen im Installationshandbuch. Bei Missachtung dieser Anweisungen kann das Gerät umfallen, umkippen oder Geräusche, Vibrationen, Wasseraustritte usw. verursachen.
- Die angegebenen Schrauben (M10) und Muttern (M10) zum Befestigen des Außengeräts müssen beim Installieren des Geräts verwendet werden.
- Installieren Sie das Außengerät ordnungsgemäß an einem Ort, der stark genug ist, das Gewicht des Außengeräts zu tragen. Ist die Konstruktion nicht tragfähig, kann das Außengerät herunterfallen und Verletzungen verursachen.
- Wenn während der Installation Kältemittel ausgetreten ist, lüften Sie den Raum umgehend. Beim Kontakt des Kältemittelgases mit einer offenen Flamme können giftige Gase gebildet werden.
- Die Installation von Rohrleitungen ist auf ein Minimum zu beschränken.

Kühlmittleitungen

- Überprüfen Sie die sichere Installation der Kühlmittleitung, bevor Sie das Klimagerät in Betrieb nehmen. Falls der Kompressor bei geöffnetem Ventil und ohne Kühlmittelrohr betrieben wird, saugt er Luft ein, und der Gasdruck im Kühlkreislauf wird extrem hoch, was zu Verletzungen führen kann.
- Ziehen Sie die Bördelmutter mit einem Drehmomentschlüssel wie angegeben fest. Übermäßiges Festziehen der Bördelmutter kann nach längerer Zeit zu Rissen in der Bördelmutter führen, wodurch Kühlmittel auslaufen kann.

- Für Installations- und Verlegungsarbeiten müssen die Anweisungen im Installationshandbuch befolgt werden. Es dürfen dazu nur Werkzeuge und Rohrleitungskomponenten verwendet werden, die speziell für den Einsatz mit dem Kältemittel R32 vorgesehen sind. Wenn Rohrleitungskomponenten verwendet werden, die nicht für das Kältemittel R32 ausgelegt sind und das Gerät nicht korrekt installiert ist, können die Leitungen platzen und Schäden oder Verletzungen hervorrufen. Außerdem kann dies zu Wasseraustritt, Stromschlag oder Brand führen.
- Für die Luftdichteprüfung muss Stickstoff verwendet werden.
- Der Zuleitungsschlauch muss so angeschlossen werden, dass er nicht durchhängt.

Elektrische Verdrahtung

- Nur ein qualifizierter Installateur(*1) oder ein qualifizierter Servicetechniker(*1) darf Elektroarbeiten an der Klimaanlage ausführen. Unter keinen Umständen dürfen diese Arbeiten von unqualifizierten Mitarbeitern ausgeführt werden, da eine nicht sachgemäße Ausführung der Arbeit zu elektrischen Schlägen und/oder Kriechströmen führen kann.
- Bei der Installation des Geräts müssen die nationalen Verdrahtungsvorschriften eingehalten werden. Leistungseinschränkungen im Stromkreis oder eine fehlerhafte Installation können elektrische Schläge oder Brände verursachen.
- Beachten Sie beim Legen von elektrischen Leitungen die Spezifikationen im Installationshandbuch sowie die Bestimmungen der lokalen Gesetze und die Rechtsvorschriften. Bei Verwendung von Kabeln, die die Spezifikationen nicht erfüllen, kann es zu Stromschlägen, Kriechströmen, Rauchentwicklungen und/oder Bränden kommen.
- Stellen Sie sicher, dass das Erdungskabel angeschlossen ist. (Erdungsarbeiten)
Durch unzureichende Erdung können Sie einen elektrischen Schlag erleiden.

- Schließen Sie die Erdungsleiter nicht an Gasrohre, Wasserleitungsrohre, Blitzableiter oder den Massedraht von Telefonen an.
- Prüfen Sie nach Abschluss der Reparatur- oder Umsetzungsarbeiten, ob die Erdungsleiter korrekt angeschlossen sind.
- Installieren Sie einen Schutzschalter, der die Spezifikationen im Installationshandbuch sowie die Bestimmungen der lokalen Gesetze und die Rechtsvorschriften erfüllt.
- Bringen Sie den Schutzschalter an einem Ort an, wo er vom Bediener problemlos erreicht werden kann.
- Wenn der Schutzschalter im Freien installiert werden soll, verwenden Sie einen Outdoor-Schutzschalter.
- Das Stromkabel darf unter keinen Umständen durch ein Verlängerungskabel erweitert werden. Bei Anschlussproblemen des Kabels an den Verlängerungsstellen kann es zu Rauchentwicklungen und/oder Bränden kommen.

Testlauf

- Bevor Sie die Klimaanlage nach Abschluss der Arbeiten betreiben, stellen Sie sicher, dass die Abdeckung des Elektrokastens am Innengerät und das Wartungspaneel des Außengeräts geschlossen sind, und stellen Sie den Schutzschalter auf die Position ON (ein). Sie können einen Stromschlag oder andere Verletzung erleiden, wenn das Gerät eingeschaltet wird, ohne dass Sie dies vorher sichergestellt haben.
- Wenn Sie festgestellt haben, dass Probleme mit der Klimaanlage aufgetreten sind (z. B. eine Prüfanzeige erscheint, es riecht verbrannt, ungewöhnliche Geräusche sind zu hören, die Klimaanlage kühlt bzw. heizt nicht oder Wasser läuft aus), dann manipulieren Sie nicht selbst an der Klimaanlage, sondern stellen Sie den Schutzschalter auf die Position OFF (aus) und wenden Sie sich an einen Servicetechniker. Stellen Sie sicher, dass der Strom nicht wieder eingeschaltet wird (indem Sie beispielsweise den Schutzschalter durch „außer Betrieb“ kennzeichnen), bis ein qualifizierter Servicetechniker eintrifft. Die weitere Verwendung der Klimaanlage in diesem fehlerhaften Zustand kann zur Verschlimmerung der mechanischen Probleme oder zu elektrischen Schlägen usw. führen.

- Nachdem die Arbeiten abgeschlossen wurden, stellen Sie unbedingt mit einem Isolationsprüfgerät (500 VMΩ) sicher, dass der Widerstand zwischen dem geladenen Teil und dem nichtgeladenen Metallteil (Erdungsbereich) 1 MΩ oder mehr beträgt. Falls der Widerstandswert zu niedrig ist, können an der Benutzerseite Kriechströme oder Stromschläge verursacht werden.
- Stellen Sie nach Abschluss der Installationsarbeiten sicher, dass kein Kühlmittel ausläuft, und prüfen Sie Isolierwiderstand sowie Wasserableitung. Führen Sie danach einen Testlauf durch, um sicherzustellen, dass die Klimaanlage ordnungsgemäß funktioniert.
- Vergewissern Sie sich daher nach der Installation noch einmal, dass kein Kältemittel austreten kann. Wenn Kältemittelgase austreten und in einen Raum mit einem Herd oder Ofen gelangen, kann es bei einer offenen Flamme zur Bildung von gesundheitsschädlichen Gasen kommen.

Dem Benutzer mitzuteilende Informationen

- Teilen Sie dem Benutzer nach Abschluss der Installationsarbeiten mit, wo sich der Schutzschalter befindet. Sollte der Benutzer nicht wissen, wo sich der Schutzschalter befindet, kann er diesen nicht ausschalten, falls Probleme mit der Klimaanlage auftreten.
- Wenn der Lüfterschutz beschädigt ist, das Außengerät selbst nicht anrühren, sondern den Schutzschalter ausschalten und einen Kundendienstfachmann(*1) rufen. Stellen Sie den Schutzschalter erst wieder auf die Position ON (ein), nachdem die Reparaturen abgeschlossen wurden.
- Nach Abschluss der Installationsarbeiten erläutern Sie dem Kunden die Verwendung und Wartung des Geräts entsprechend dem Benutzerhandbuch.

Umsetzung

- Nur ein qualifizierter Installateur(*1) oder ein qualifizierter Servicetechniker(*1) darf die Klimaanlage umsetzen. Es ist gefährlich, wenn die Klimaanlage durch einen nicht qualifizierten Benutzer umgesetzt wird, da es zu Bränden, elektrischen Schlägen, Verletzungen, Wasseraustritten, Geräuschen und/oder Vibrationen kommen kann.
- Schließen Sie beim Durchführen der Abpumparbeiten zuerst den Kompressor, bevor Sie das Kühlmittelrohr trennen. Sollte das Kühlmittelrohr getrennt werden, obwohl das Serviceventil geöffnet ist und der Kompressor noch läuft, kommt es zum Einsaugen von Luft oder anderen Stoffen, wodurch der Druck im Inneren des Kühlkreislafs auf einen anormal hohen Pegel steigt und es in der Folge zu Verletzungen und Beschädigungen kommen kann.

(*1) Siehe „Definition der Bezeichnungen „Qualifizierter Installateur“ oder „Qualifizierter Servicetechniker““.

VORSICHT

In dieser Klimaanlage wird das HFC-Kältemittel (R32) eingesetzt, das für die Ozonschicht unschädlich ist

- Das Kältemittel R32 hat einen hohen Arbeitsdruck und kann durch Verunreinigungen wie Wasser, oxidierende Membranen und Öle beeinträchtigt werden. Achten Sie daher bei der Installation darauf, dass kein Wasser, Staub, früheres Kältemittel, Kältemaschinenöl oder andere Substanzen in den R32-Kältemittelkreislauf gelangen.
- Für die Installation sind Spezialwerkzeuge für das Kältemittel R32 oder R410A erforderlich.
- Verwenden Sie für den Anschluss von Rohrleitungen neue und saubere Rohrmaterialien, und achten Sie darauf, dass kein Wasser und/oder Staub eindringen kann.

Vorsichtsmaßnahmen für den Installationsraum des Außengerätes

- Wenn das Außengerät auf engstem Raum installiert wird und Kältemittel austritt, kann die Ansammlung von hochkonzentriertem Kältemittel eine Brandgefahr darstellen. Befolgen Sie daher unbedingt die Installationsanweisungen im Installationshandbuch, und halten Sie an mindestens einer der vier Seiten des Außengerätes den Raum frei.
- Besonders dann, wenn Wände sowohl an der Auslass- als auch an der Einlassseite, und Hindernisse beidseitig des Außengerätes vorhanden sind, muss ausreichend freier Platz geschaffen werden. Damit sich kein austretendes Kältemittel ansammeln kann, muss der Platz so bemessen sein, dass auf einer Seite eine Person passieren kann (600 mm oder mehr).

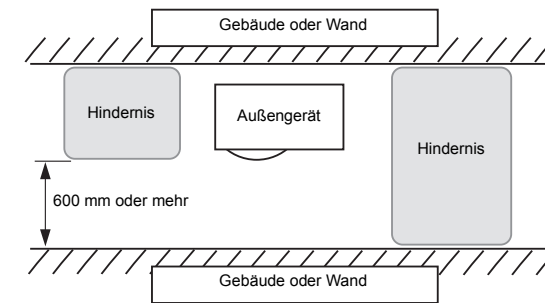

Trennen des Gerätes von der Hauptstromversorgung

- Das Gerät muss über einen Schalter, dessen Kontakte einen Mindestabstand von 3 mm haben, an die Hauptstromversorgung angeschlossen werden.

Waschen Sie Klimageräte nicht mit Hochdruckreinigern.

- Leckströme können elektrische Schläge oder Brände verursachen.

Grazie per aver acquistato questo condizionatore d'aria Toshiba.

Leggere attentamente queste istruzioni, che contengono informazioni importanti di conformità con la "Direttiva macchine" (Direttiva 2006/42/CE), e assicurarsi di averle comprese.

Al termine della lettura delle presenti istruzioni, assicurarsi di conservarle in un luogo sicuro, insieme al Manuale del proprietario e al Manuale di installazione in dotazione con il prodotto.

Denominazione generica: Condizionatore d'aria

Definizione di installatore qualificato o tecnico dell'assistenza qualificato

Il condizionatore d'aria deve essere installato, sottoposto a manutenzione, riparato e rimosso da un installatore qualificato o da un tecnico dell'assistenza qualificato. Quando deve essere eseguito uno di questi lavori, rivolgersi a un installatore qualificato o a un tecnico dell'assistenza qualificato per svolgerli in propria vece.

Un installatore qualificato o un tecnico dell'assistenza qualificato è un agente che dispone delle qualifiche e dell'esperienza descritti nella tabella seguente.

Agente	Qualifiche ed esperienza di cui deve disporre l'agente
Installatore qualificato	<ul style="list-style-type: none"> L'installatore qualificato è una persona che installa, sottopone a manutenzione, trasferisce e rimuove i condizionatori d'aria prodotti da Toshiba Carrier Corporation. Questa persona è stata addestrata a installare, sottoporre a manutenzione, trasferire e rimuovere i condizionatori d'aria prodotti da Toshiba Carrier Corporation o, in alternativa, ha ricevuto istruzioni relative a tali operazioni da parte di uno o più individui che sono stati addestrati e, pertanto, ha piena dimestichezza con le nozioni relative a tali operazioni. L'installatore qualificato che è autorizzato a svolgere i lavori sull'impianto elettrico implicati nell'installazione, nel trasferimento e nella rimozione, dispone delle qualifiche relative a tali lavori sull'impianto elettrico, definite dalle leggi e dalle normative locali, e tale persona è stata addestrata relativamente agli argomenti pertinenti ai lavori sugli impianti elettrici per i condizionatori d'aria prodotti da Toshiba Carrier Corporation, o, in alternativa, ha ricevuto istruzioni relative a tali argomenti da parte di uno o più individui che sono stati addestrati e, pertanto, ha piena dimestichezza con le nozioni relative a tali lavori. L'installatore qualificato che è autorizzato a occuparsi della gestione del refrigerante e dei lavori sulle tubature implicati nell'installazione, nel trasferimento e nella rimozione, dispone delle qualifiche relative a tale gestione del refrigerante e a tali lavori sulle tubature, definite dalle leggi e dalle normative locali, e tale persona è stata addestrata relativamente agli argomenti pertinenti alla gestione del refrigerante e ai lavori sulle tubature per i condizionatori d'aria prodotti da Toshiba Carrier Corporation o, in alternativa, ha ricevuto istruzioni relative a tali argomenti da parte di uno o più individui che sono stati addestrati e, pertanto, ha piena dimestichezza con le nozioni relative a tali lavori. L'installatore qualificato che è autorizzato a lavorare in altezza è stato addestrato relativamente agli argomenti pertinenti al lavoro in altezza con i condizionatori d'aria prodotti da Toshiba Carrier Corporation o, in alternativa, ha ricevuto istruzioni relative a tali argomenti da parte di uno o più individui che sono stati addestrati e, pertanto, ha piena dimestichezza con le nozioni relative a tali lavori.

Tecnico dell'assistenza qualificato	<ul style="list-style-type: none"> Il tecnico dell'assistenza qualificato è una persona che installa, ripara, sottopone a manutenzione, trasferisce e rimuove i condizionatori d'aria prodotti da Toshiba Carrier Corporation. Tale persona è stata addestrata a installare, riparare, sottoporre a manutenzione, trasferire e rimuovere i condizionatori d'aria prodotti da Toshiba Carrier Corporation o, in alternativa, ha ricevuto istruzioni relative a tali operazioni da parte di uno o più individui che sono stati addestrati e, pertanto, ha piena dimestichezza con le nozioni relative a tali operazioni. Il tecnico dell'assistenza qualificato che è autorizzato a svolgere lavori sugli impianti elettrici durante l'installazione, la riparazione, il trasferimento e la rimozione dispone delle qualifiche relative a tali lavori sugli impianti elettrici, definite dalle leggi e dalle normative locali, e tale persona è stata addestrata relativamente agli argomenti pertinenti ai lavori sugli impianti elettrici per i condizionatori d'aria prodotti da Toshiba Carrier Corporation o, in alternativa, ha ricevuto istruzioni relative a tali argomenti da parte di uno o più individui che sono stati addestrati e, pertanto, ha piena dimestichezza con le nozioni relative a tali lavori. Il tecnico dell'assistenza qualificato che è autorizzato a occuparsi della gestione del refrigerante e dei lavori sulle tubature implicati nell'installazione, riparazione, trasferimento e rimozione dispone delle qualifiche relative a tale gestione del refrigerante e a tali lavori sulle tubature, definite dalle leggi e dalle normative locali, e tale persona è stata addestrata relativamente agli argomenti pertinenti alla gestione del refrigerante e ai lavori sulle tubature per i condizionatori d'aria prodotti da Toshiba Carrier Corporation o, in alternativa, ha ricevuto istruzioni relative a tali argomenti da parte di uno o più individui che sono stati addestrati e, pertanto, ha piena dimestichezza con le nozioni relative a tali lavori. Il tecnico dell'assistenza qualificato che è autorizzato a lavorare in altezza è stato addestrato relativamente agli argomenti pertinenti al lavoro in altezza con i condizionatori d'aria prodotti da Toshiba Carrier Corporation, o, in alternativa, ha ricevuto istruzioni relative a tali argomenti da parte di uno o più individui che sono stati addestrati e, pertanto, ha piena dimestichezza con le nozioni relative a tale lavoro.
-------------------------------------	--

Definizione di attrezzatura protettiva

Quando è necessario trasportare, installare, sottoporre a manutenzione, riparare o rimuovere il condizionatore d'aria, indossare guanti di protezione e indumenti da lavoro di sicurezza.

Oltre alla normale attrezzatura protettiva, indossare l'attrezzatura protettiva descritta di seguito quando si intraprendono i lavori speciali descritti in dettaglio nella tabella seguente.



Qualora non si indossi l'attrezzatura protettiva appropriata, si corre un pericolo, in quanto si sarà più suscettibili a lesioni personali, ustioni, scosse elettriche e altri infortuni.

Lavoro intrapreso	Attrezzatura protettiva indossata
Tutti i tipi di lavori	Guanti protettivi Indumenti da lavoro di sicurezza
Lavoro su impianti elettrici	Guanti per fornire protezione dalle scosse elettriche Scarpe isolanti Indumenti per fornire protezione da scosse elettriche
Lavoro in altezza (a più di 50 cm di altezza)	Elmetti per uso industriale
Trasporto di oggetti pesanti	Scarpe con calotte protettive aggiuntive
Riparazione dell'unità esterna	Guanti per fornire protezione dalle scosse elettriche

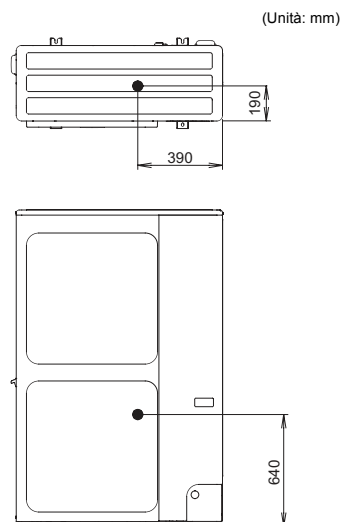
■ Centro di gravità



Le presenti istruzioni di sicurezza descrivono argomenti importanti relativi alla sicurezza per evitare lesioni personali agli utenti e ad altre persone, nonché danni alle cose. Leggere a fondo il presente manuale dopo averne compreso i contenuti seguenti (significati delle indicazioni), e accertarsi di attenersi alla descrizione.





Indicazione	Significato dell'indicazione
 AVVERTIMENTO	Il testo evidenziato in questo modo indica che la mancata conformità alle indicazioni nell'avvertenza in questione potrebbe causare gravi lesioni personali (*1) o la perdita della vita, qualora il prodotto venga maneggiato in modo improprio.
 ATTENZIONE	Il testo evidenziato in questo modo indica che la mancata conformità alle indicazioni nell'avvertenza in questione potrebbe risultare in lievi lesioni personali (*2) o danni (*3) alle cose, qualora il prodotto venga maneggiato in modo improprio.



*1: il termine "gravi lesioni personali" si riferisce a perdita della vista, lesioni corporee, ustioni, scosse elettriche, fratture ossee, avvelenamento e altre lesioni personali che lasciano postumi e richiedono il ricovero in ospedale o terapie ambulatoriali a lungo termine.



*2: il termine "lievi lesioni personali" si riferisce a lesioni corporee, ustioni, scosse elettriche e altre lesioni personali che non richiedono il ricovero in ospedale o terapie ambulatoriali a lungo termine.

*3: il termine "danni alle cose" si riferisce a danni che si estendono a edifici, effetti personali domestici, bestiame domestico e animali da compagnia.

■ **Indicazioni di avvertimento sul condizionatore d'aria**

	AVVERTIMENTO (Rischio di incendio)	Questa indicazione è esclusivamente per il refrigerante R32. Il tipo di refrigerante è riportato sulla targhetta di identificazione dell'unità esterna. Qualora il tipo di refrigerante sia R32, questa unità utilizza un refrigerante infiammabile. Qualora si verifichi una perdita di refrigerante e quest'ultimo entri in contatto col fuoco o parti riscaldanti, viene generato gas nocivo e sussiste il rischio di incendio.
	Leggere il MANUALE DEL PROPRIETARIO con attenzione prima dell'uso.	
	È richiesto che il personale di assistenza legga con attenzione il MANUALE DEL PROPRIETARIO e il MANUALE DI INSTALLAZIONE, prima dell'uso.	
	Ulteriori informazioni sono disponibili nel MANUALE DEL PROPRIETARIO, nel MANUALE DI INSTALLAZIONE e in documenti simili.	

Indicazione di avvertimento	Descrizione		
 <table border="1"> <tr> <td>WARNING</td> </tr> <tr> <td>ELECTRICAL SHOCK HAZARD Disconnect all remote electric power supplies before servicing.</td> </tr> </table>	WARNING	ELECTRICAL SHOCK HAZARD Disconnect all remote electric power supplies before servicing.	AVVERTIMENTO PERICOLO DI SCOSSA ELETTRICA Scollegare tutte le fonti di alimentazione elettrica remote, prima di sottoporre a interventi di assistenza.
WARNING			
ELECTRICAL SHOCK HAZARD Disconnect all remote electric power supplies before servicing.			
 <table border="1"> <tr> <td>WARNING</td> </tr> <tr> <td>Moving parts. Do not operate unit with grille removed. Stop the unit before the servicing.</td> </tr> </table>	WARNING	Moving parts. Do not operate unit with grille removed. Stop the unit before the servicing.	AVVERTIMENTO Parti mobili. Non far funzionare l'unità con la griglia rimossa. Arrestare l'unità prima di sottoporla ad assistenza.
WARNING			
Moving parts. Do not operate unit with grille removed. Stop the unit before the servicing.			
 <table border="1"> <tr> <td>CAUTION</td> </tr> <tr> <td>High temperature parts. You might get burned when removing this panel.</td> </tr> </table>	CAUTION	High temperature parts. You might get burned when removing this panel.	ATTENZIONE Parti ad alta temperatura. Quando si rimuove questo pannello sussiste il pericolo di ustione.
CAUTION			
High temperature parts. You might get burned when removing this panel.			

 <table border="1"> <tr> <td>CAUTION</td> </tr> <tr> <td>Do not touch the aluminum fins of the unit. Doing so may result in injury.</td> </tr> </table>	CAUTION	Do not touch the aluminum fins of the unit. Doing so may result in injury.	ATTENZIONE Non toccare le alette di alluminio dell'unità. In caso contrario, si potrebbero provocare lesioni personali.
CAUTION			
Do not touch the aluminum fins of the unit. Doing so may result in injury.			
 <table border="1"> <tr> <td>CAUTION</td> </tr> <tr> <td>BURST HAZARD Open the service valves before the operation, otherwise there might be the burst.</td> </tr> </table>	CAUTION	BURST HAZARD Open the service valves before the operation, otherwise there might be the burst.	ATTENZIONE PERICOLO DI SCOPPIO Aprire le valvole di servizio prima dell'operazione; in caso contrario, si potrebbe verificare uno scoppio.
CAUTION			
BURST HAZARD Open the service valves before the operation, otherwise there might be the burst.			

1 PRECAUZIONI DI SICUREZZA

Il produttore rifiuta qualsiasi responsabilità per eventuali danni causati dall'inosservanza delle istruzioni fornite in questo manuale.

⚠ AVVERTIMENTO

Generali

- Prima di iniziare a installare il condizionatore d'aria, leggere attentamente il Manuale di installazione e seguire le relative istruzioni per installare il condizionatore d'aria.
- Solo un installatore qualificato(*1) o un tecnico dell'assistenza qualificato(*1) sono autorizzati a installare il condizionatore d'aria. L'eventuale installazione del condizionatore d'aria da parte di una persona non qualificata potrebbe causare incendi, scosse elettriche, lesioni personali, perdite d'acqua, rumori e/o vibrazioni.
- Sia per la sostituzione sia per il rabbocco si deve usare esclusivamente il tipo di refrigerante specificato. In caso contrario nel circuito di refrigerazione si potrebbe creare una pressione anomala con la conseguente possibilità di guasto o esplosione oltre che di lesione alle persone.
- Per trasportare il condizionatore d'aria, utilizzare un elevatore a forca, e quando si intende spostare il condizionatore d'aria a mano, spostare l'unità insieme a 4 persone.
- Prima di aprire la griglia della presa d'aria dell'unità interna o il pannello di servizio dell'unità esterna, impostare l'interruttore automatico sulla posizione OFF (spento). La mancata impostazione dell'interruttore automatico sulla posizione OFF (spento) potrebbe provocare scosse elettriche attraverso il contatto con le parti interne. Solo un installatore qualificato(*1) o un tecnico dell'assistenza qualificato(*1) sono autorizzati a rimuovere la griglia della presa d'aria o il pannello di servizio dell'unità esterna e a svolgere il lavoro richiesto.
- Prima di eseguire lavori di installazione, manutenzione, riparazione o rimozione, assicurarsi di impostare l'interruttore automatico sulla posizione OFF (spento). In caso contrario, si potrebbero causare scosse elettriche.
- Sistemare un cartello con l'indicazione "Lavori in corso" in prossimità dell'interruttore automatico durante l'esecuzione di lavori di installazione, manutenzione, riparazione o rimozione. Qualora l'interruttore automatico sia impostato su ON (acceso) per errore, sussiste il pericolo di scosse elettriche.
- Solo un installatore qualificato(*1) o un tecnico dell'assistenza qualificato(*1) sono autorizzati a eseguire lavori in altezza utilizzando un supporto di 50 cm o più.
- Durante l'installazione, la manutenzione e la rimozione, indossare guanti di protezione e indumenti da lavoro di sicurezza.
- Non toccare l'aletta di alluminio dell'unità esterna. In caso contrario, si potrebbero provocare lesioni personali. Qualora sia necessario toccare l'aletta per qualche motivo, indossare prima guanti di protezione e indumenti da lavoro di sicurezza, quindi procedere.
- Non salire né collocare oggetti sull'unità esterna. Si potrebbe cadere o gli oggetti potrebbero cadere dalla superficie superiore dell'unità esterna e causare lesioni personali.
- Quando si lavora in altezza, utilizzare una scala conforme allo standard ISO 14122, e attenersi alla procedura indicata nelle istruzioni della scala. Inoltre, indossare un elmetto per uso industriale come attrezzatura di protezione per intraprendere il lavoro.
- Quando si lavora in altezza, sistemare un cartello in modo che nessuno si avvicini alla sede dei lavori, prima di procedere con i lavori. Parti e altri oggetti potrebbero cadere dall'alto, con la possibilità di provocare lesioni personali a chi si trovi sotto.
- Accertarsi che il condizionatore d'aria venga trasportato in condizioni stabili. Qualora una qualsiasi parte del prodotto sia rotta, contattare il rivenditore.

- Non modificare i prodotti. Non disassemblare o modificare i componenti. Ciò potrebbe infatti divenire causa d'incendio, scosse elettriche o lesioni personali.
- Questo apparecchio è destinato all'uso da parte di utenti esperti o addestrati all'interno di negozi del settore o per uso commerciale da parte di utenti comuni.

Informazioni relative al refrigerante

- Questo prodotto contiene gas serra fluorurati.
- Non rilasciare i gas nell'atmosfera.
- L'elettrodomestico va conservato in una stanza priva di fonti di combustione a funzionamento continuo (ad esempio: fiamme esposte, un elettrodomestico a gas in funzione o una stufa elettrica in funzione).
- Non perforare né bruciare le parti relative al ciclo del refrigerante.
- Non utilizzare mezzi diversi da quelli consigliati dal produttore per accelerare il processo di sbrinatoria o per pulire.
- Tenere presente che i refrigeranti potrebbero essere inodori.
- Il refrigerante all'interno dell'unità è infiammabile. Qualora il refrigerante fuoriesca nella stanza ed entri in contatto con fiamme provenienti da un bruciatore, una stufa o un fornello, potrebbe risultare in un incendio o nella formazione di gas nocivo.
- Spegnerne qualsiasi dispositivo di riscaldamento a combustibile, ventilare la stanza e contattare il rivenditore dal quale è stata acquistata l'unità.
- Non utilizzare l'unità fino a quando un tecnico dell'assistenza abbia confermato che la parte da cui è fuoriuscito il refrigerante sia stata riparata.
- Quando si intende installare, traslocare o sottoporre ad assistenza il condizionatore d'aria, utilizzare esclusivamente il refrigerante specificato (R32) per caricare il circuito del refrigerante. Non mescolarlo con altri refrigeranti né consentire che resti dell'aria nel circuito.
- Le tubazioni devono essere protette da danneggiamenti fisici.
- È necessario osservare la conformità alle normative nazionali sul gas.

Selezione della sede di installazione

- Se si installa l'unità in una stanza piccola, adottare le misure appropriate affinché, in caso di perdita di refrigerante, la concentrazione di quest'ultimo nella stanza non superi il limite consentito. Quando si implementano tali misure, consultare il rivenditore da cui si è acquistato il condizionatore d'aria. L'accumulo di elevate concentrazioni di refrigerante potrebbe provocare un incidente dovuto a carenza di ossigeno.
- Non installare il condizionatore d'aria in una sede che possa essere soggetta al rischio di esposizione a gas combustibili. Qualora si verifici una perdita e la concentrazione di un gas combustibile in prossimità dell'apparecchio, sussiste il rischio di incendio.
- Quando si intende trasportare il condizionatore d'aria, indossare scarpe con calotte protettive aggiuntive.
- Quando si trasporta il condizionatore d'aria, non afferrare le fascette che circondano la scatola di imballaggio. Qualora le fascette si rompano, si potrebbero subire lesioni personali.
- Non collocare apparecchi a combustione di alcun genere in luoghi che siano direttamente esposti al flusso d'aria prodotto dal condizionatore d'aria; in caso contrario, il condizionatore potrebbe provocare una combustione imperfetta.
- Non installare il condizionatore d'aria in uno spazio scarsamente ventilato che sia più piccolo dell'area minima sul pavimento (Amin). Questo si applica a:
 - Unità interne
 - Unità esterne installate (ad es.: giardino d'inverno, garage, sala macchine, e così via).
 Fare riferimento al capitolo "15 APPENDICE - [2] Area minima sul pavimento: Amin (m²)" per stabilire l'area minima sul pavimento.

Installazione

- Installare il condizionatore d'aria in sedi che offrano una resistenza sufficiente a sostenere il peso dell'unità. Qualora la resistenza non sia sufficiente, l'unità potrebbe cadere e provocare lesioni personali.
- Attenersi alle istruzioni nel Manuale di installazione per installare il condizionatore d'aria. La mancata osservanza di queste istruzioni potrebbe provocare la caduta o il rovesciamento del prodotto, oppure produrre rumori, vibrazioni, perdite d'acqua e così via.
- È necessario utilizzare i bulloni (M10) e i dadi (M10) specificati per fissare l'unità esterna, quando si installa quest'ultima.
- Installare l'unità esterna correttamente in una sede che sia sufficientemente robusta da sostenere il peso dell'unità esterna. Una robustezza insufficiente può causare la caduta dell'unità esterna, provocando lesioni personali.
- Se durante l'installazione si verifica una fuga del gas refrigerante occorre ventilare subito l'ambiente. Se il gas refrigerante fuoriuscito entra in contatto con le fiamme, è possibile che vengano generati gas tossici.
- L'installazione di tubature va ridotta al minimo.

Tubazioni del refrigerante

- Installare il tubo del refrigerante stabilmente durante i lavori di installazione, prima di mettere in funzione il condizionatore d'aria. Se il compressore venisse messo in funzione con la valvola aperta e senza il tubo del refrigerante, il compressore aspirerebbe aria e il circuito di refrigerazione raggiungerebbe una pressione eccessiva, con la possibilità di causare lesioni personali.
- Serrare il dado svasato con una chiave torsiometrica come illustrato. Un serraggio eccessivo del dado svasato potrebbe causare delle spaccature nel lungo periodo, il che potrebbe provocare perdite di refrigerante.

- Per lavori di installazione e di trasloco, attenersi alle istruzioni nel Manuale di installazione e utilizzare strumenti e componenti dei tubi specificamente realizzati per l'uso con il refrigerante R32. Qualora vengano utilizzati componenti per tubazioni che non siano progettati per il refrigerante R32 e l'unità non venga installata correttamente, i tubi potrebbero scoppiare e causare danni alle cose o lesioni personali. Inoltre, si potrebbero causare perdite d'acqua, scosse elettriche o incendi.
- Per la prova di tenuta dell'aria è necessario utilizzare gas di azoto.
- Il tubo flessibile di carico deve essere collegato in modo tale da non essere lasco.

Cablaggio elettrico

- Solo un installatore qualificato(*1) o un tecnico dell'assistenza qualificato(*1) sono autorizzati a eseguire i lavori sull'impianto elettrico per il condizionatore d'aria. In nessuna circostanza tali lavori devono essere effettuati da una persona non qualificata, poiché un'esecuzione non appropriata dei lavori potrebbe provocare scosse elettriche e/o dispersioni di corrente.
- Eseguire il collegamento delle varie unità in accordo alle norme locali in atto. Riduzioni di capacità del circuito di alimentazione o un'installazione incompleta possono causare scosse elettriche o incendi.
- Utilizzare cablaggi che soddisfino le specifiche nel Manuale di installazione e le direttive delle norme e nelle leggi locali. L'uso di cablaggi che non soddisfino le specifiche potrebbe provocare scosse elettriche, dispersioni di corrente, fumo e/o un incendio.
- Assicurarsi di collegare il filo di messa a terra. (cablaggio di messa a terra) Una messa a terra incompleta può provocare una scossa elettrica.
- Non collegare i fili elettrici di messa a terra a tubi del gas, tubi dell'acqua e parafulmini o fili elettrici di messa a terra per cavi telefonici.
- Dopo aver completato i lavori di riparazione o di trasferimento, verificare che i fili elettrici di messa a terra siano collegati correttamente.

- Installare un interruttore automatico che soddisfi le specifiche nel Manuale di installazione e le direttive delle norme e delle leggi locali.
- Installare l'interruttore automatico in una sede che sia facilmente accessibile dall'agente.
- Quando si installa l'interruttore automatico all'aperto, installarne uno progettato per l'uso per esterno.
- Non utilizzare in alcuna circostanza prolunghe del cavo elettrico di alimentazione. Problemi di collegamento nelle sedi in cui si trovino prolunghe del cavo elettrico possono provocare fumo e/o un incendio.

Prova di funzionamento

- Prima di far funzionare il condizionatore d'aria, dopo aver completato il lavoro, verificare che il coperchio della cassetta dei componenti elettrici dell'unità interna e il pannello di servizio dell'unità esterna siano chiusi, e che l'interruttore automatico sia impostato sulla posizione ON (acceso). Qualora si accenda l'unità senza aver prima eseguito questi controlli, si potrebbe subire una scossa elettrica o altre lesioni.
- Se si nota il verificarsi di un problema di qualche tipo con il condizionatore d'aria (per esempio quando è apparso un display di controllo, si sente odore di bruciato, si sentono suoni anomali, il condizionatore non raffredda o non riscalda, o è presente una perdita d'acqua), non toccare da soli il condizionatore d'aria, ma impostare l'interruttore di circuito sulla posizione OFF (spento) e contattare un tecnico dell'assistenza qualificato. Adottare delle misure per assicurare che l'unità non venga accesa (ad esempio scrivendo "fuori servizio" in prossimità dell'interruttore automatico) fino all'arrivo di un tecnico dell'assistenza qualificato. Qualora si continui a utilizzare il condizionatore d'aria in presenza di un problema, si potrebbe provocare il peggioramento dei problemi meccanici o produrre scosse elettriche, e così via.

- Al termine del lavoro, assicurarsi di utilizzare un misuratore di isolamento (500 VMΩ) per controllare che la resistenza sia almeno 1 MΩ tra la sezione sotto carico elettrico e la sezione di metallo che non è sotto carico elettrico (sezione di terra). Qualora il valore di resistenza sia basso, potrebbe verificarsi un grave problema, quale una dispersione o una scossa elettrica, dal lato dell'utente.
- Al completamento del lavoro di installazione, controllare eventuali perdite di refrigerante e controllare la resistenza di isolamento e lo scarico dell'acqua. Quindi, eseguire un funzionamento di prova per controllare che il condizionatore d'aria funzioni correttamente.
- Una volta completata l'installazione è quindi di estrema importanza verificare che non vi siano perdite. Qualora si verifichi una perdita di gas refrigerante in una stanza e il gas entri in contatto con delle fiamme, ad esempio in una cucina, si potrebbero generare gas tossici.

Spiegazioni fornite all'utente

- Al completamento del lavoro di installazione, comunicare all'utente dove sia situato l'interruttore automatico. Qualora l'utente non sappia dove si trovi l'interruttore automatico, non sarà in grado di disattivarlo, nell'eventualità che si verifichi un problema con il condizionatore d'aria.
- Se si scopre che la protezione della ventola è danneggiata, non avvicinarsi all'unità esterna, ma portare l'interruttore di circuito in posizione OFF e rivolgersi a un tecnico di assistenza qualificato(*1) perché provveda a effettuare le riparazioni. Non impostare l'interruttore automatico sulla posizione ON (acceso) finché non siano state completate le riparazioni.
- Al termine del lavoro di installazione, seguire il Manuale del proprietario per spiegare al cliente come utilizzare e sottoporre a manutenzione l'unità.

Trasferimento

- Solo un installatore qualificato(*1) o un tecnico dell'assistenza qualificato(*1) sono autorizzati a trasferire il condizionatore d'aria. È pericoloso far trasferire il condizionatore d'aria da una persona non qualificata, in quanto si potrebbero provocare incendi, scosse elettriche, lesioni personali, perdite d'acqua, rumori e/o vibrazioni.
- Quando si eseguono lavori di svuotamento del refrigerante (Pump-down), spegnere il compressore prima di scollegare il tubo del refrigerante. Qualora si scolleghi il tubo del refrigerante con la valvola di servizio aperta e il compressore ancora in funzione, si provocherebbe il risucchio d'aria, e così via, il che farebbe innalzare a un livello anormale la pressione all'interno del circuito di refrigerazione, con la possibilità di provocare scoppi, lesioni personali, e così via.

(*1) Consultare la "Definizione di installatore qualificato o tecnico dell'assistenza qualificato".

⚠ ATTENZIONE

Questo condizionatore d'aria adotta il refrigerante HFC (R32) che non distrugge lo strato di ozono

- Il refrigerante R32 ha un'elevata pressione di esercizio, ed è soggetto all'influenza negativa di impurità quali acqua, membrana ossidante e oli. Pertanto, durante il lavoro di installazione, fare attenzione affinché acqua, polveri, refrigerante precedente, olio per macchine refrigeranti o altre sostanze non penetrino nel ciclo di refrigerazione dell'R32.
- Per l'installazione sono necessari strumenti speciali per i refrigeranti R32 o R410A.
- Per i tubi di collegamento, utilizzare materiale per tubazioni nuovo e pulito, e accertarsi che non penetrino acqua e/o polveri.

Precauzioni relative allo spazio di installazione dell'unità esterna

- Qualora l'unità esterna sia installata in uno spazio ristretto e si verifichi una perdita di refrigerante, l'accumulo di refrigerante altamente concentrato potrebbe causare un pericolo di incendio. Pertanto, accertarsi di seguire le istruzioni relative allo spazio di installazione nel Manuale di installazione, e fornire uno spazio aperto su almeno uno dei quattro lati dell'unità esterna.
- In particolare, qualora sia il lato di scarico che quello di aspirazione siano rivolti di fronte a delle pareti, e siano anche presenti degli ostacoli su entrambi i lati dell'unità esterna, adottare delle misure per fornire uno spazio sufficientemente ampio per il passaggio di una persona (600 mm o più) su un lato, per evitare che il refrigerante fuoriuscito si accumuli.

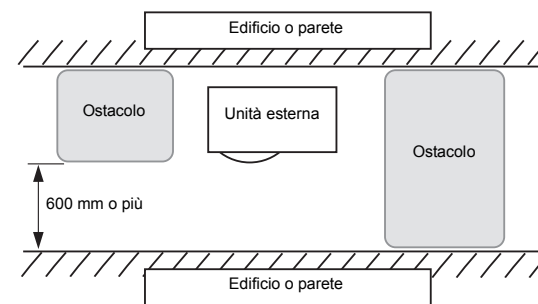

Per scollegare l'apparecchio dalla fonte di alimentazione principale

- L'unità deve essere collegata alla linea elettrica principale interponendo un interruttore di sicurezza automatico o un normale interruttore con almeno 3 mm di separazione fra i contatti.
- ### **Non lavare i condizionatori d'aria con idropulitrici.**
- Le dispersioni elettriche potrebbero provocare scosse elettriche o incendi.

Muchísimas gracias por haber adquirido este aparato de aire acondicionado de Toshiba.
 Por favor, lea atentamente estas instrucciones, incluyendo la información importante en relación con el cumplimiento de la "Directiva de Máquinas" (Directiva 2006/42/EC), y asegúrese de que las entiende.
 Después de leer estas instrucciones, asegúrese de guardarlas en un lugar seguro junto con el manual del propietario y el manual de instrucciones suministrado con su producto.

Denominación genérica: Aire acondicionado

Definición de instalador cualificado o persona de servicio cualificada

El aparato de aire acondicionado deberá ser instalado, mantenido, reparado y desechado por un instalador cualificado o por una persona de servicio cualificada. Cuando se tenga que hacer uno cualquiera de estos trabajos, solicite a un instalador cualificado o a una persona de servicio cualificada que le haga el trabajo solicitado.
 Un instalador cualificado o una persona de servicio cualificada es un agente con las cualificaciones y conocimientos descritos en la tabla de abajo.

Agente	Cualificaciones y conocimientos que debe tener el agente
Instalador cualificado	<ul style="list-style-type: none"> El instalador cualificado es una persona que instala, mantiene, recoloca y se deshace de los aparatos de aire acondicionado fabricados por Toshiba Carrier Corporation. Él o ella han sido formados para instalar, mantener, recolocar y deshacerse de los aparatos de aire acondicionado fabricados por Toshiba Carrier Corporation o, en otro caso, han recibido instrucciones para realizar tales operaciones de un individuo o individuos ya formados y que, por lo tanto, tienen un conocimiento extenso relacionado con estas operaciones. El instalador cualificado con permiso para realizar el trabajo eléctrico de la instalación, recolocación y desecho tiene las cualificaciones correspondientes a este trabajo eléctrico según lo estipulan las leyes y las normas locales, y él o ella es una persona que ha sido formada en temas relacionados con el trabajo eléctrico de los aparatos de aire acondicionado fabricados por Toshiba Carrier Corporation o, en otro caso, el o ella han recibido instrucciones para realizar tales trabajos de un individuo o individuos ya formados y que, por lo tanto, tienen un conocimiento extenso relacionado con este trabajo. El instalador cualificado con permiso para realizar el trabajo de manejo del refrigerante y de los tubos durante la instalación, recolocación y desecho tiene las cualificaciones correspondientes a este trabajo de manejo del refrigerante y de los tubos según lo estipulan las leyes y las normas locales, y él o ella es una persona que ha sido formada en temas relacionados con el trabajo de manejo del refrigerante y de los tubos de los aparatos de aire acondicionado fabricados por Toshiba Carrier Corporation o, en otro caso, el o ella han recibido instrucciones para realizar tales trabajos de un individuo o individuos ya formados y que, por lo tanto, tienen un conocimiento extenso relacionado con este trabajo. El instalador cualificado con permiso para trabajar en lugares altos ha sido formado en temas relacionados con el trabajo en lugares altos con aparatos de aire acondicionado fabricados por Toshiba Carrier Corporation o, en otro caso, el o ella han recibido instrucciones para realizar tales trabajos de un individuo o individuos ya formados y que, por lo tanto, tienen un conocimiento extenso relacionado con este trabajo.

Persona de servicio cualificada	<ul style="list-style-type: none"> La persona de servicio cualificada es una persona que instala, repara, mantiene, recoloca y se deshace de los aparatos de aire acondicionado fabricados por Toshiba Carrier Corporation. Él o ella han sido formados para instalar, reparar, mantener, recolocar y deshacerse de los aparatos de aire acondicionado fabricados por Toshiba Carrier Corporation o, en otro caso, han recibido instrucciones para realizar tales operaciones de un individuo o individuos ya formados y que, por lo tanto, tienen un conocimiento extenso relacionado con estas operaciones. La persona de servicio cualificada con permiso para realizar el trabajo eléctrico de la instalación, reparación, recolocación y desecho tiene las cualificaciones correspondientes a este trabajo eléctrico según lo estipulan las leyes y las normas locales, y él o ella es una persona que ha sido formada en temas relacionados con el trabajo eléctrico de los aparatos de aire acondicionado fabricados por Toshiba Carrier Corporation o, en otro caso, el o ella han recibido instrucciones para realizar tales trabajos de un individuo o individuos ya formados y que, por lo tanto, tienen un conocimiento extenso relacionado con este trabajo. La persona de servicio cualificada con permiso para realizar el trabajo de manejo del refrigerante y de los tubos durante la instalación, reparación, recolocación y desecho tiene las cualificaciones correspondientes a este trabajo de manejo del refrigerante y de los tubos según lo estipulan las leyes y las normas locales, y él o ella es una persona que ha sido formada en temas relacionados con el trabajo de manejo del refrigerante y de los tubos de los aparatos de aire acondicionado fabricados por Toshiba Carrier Corporation o, en otro caso, el o ella han recibido instrucciones para realizar tales trabajos de un individuo o individuos ya formados y que, por lo tanto, tienen un conocimiento extenso relacionado con este trabajo. La persona de servicio cualificada con permiso para trabajar en lugares altos ha sido formada en temas relacionados con el trabajo en lugares altos con aparatos de aire acondicionado fabricados por Toshiba Carrier Corporation o, en otro caso, el o ella han recibido instrucciones para realizar tales trabajos de un individuo o individuos ya formados y que, por lo tanto, tienen un conocimiento extenso relacionado con este trabajo.
---------------------------------	--

Definición del equipo de protección

Cuando el aparato de aire acondicionado vaya a ser transportado, instalado, mantenido, reparado o desechado, póngase guantes de protección y ropas de trabajo seguras.

Además de tal equipo de protección normal, póngase el equipo de protección descrito más abajo cuando realice trabajos especiales como los descritos en la tabla de abajo.

No ponerse el equipo de protección adecuado puede resultar peligroso porque quedará más expuesto a sufrir lesiones, quemaduras, descargas eléctricas y otros daños.

Trabajo realizado	Equipo de protección usado
Todo tipo de trabajos	Guantes de protección Ropa de trabajo segura
Trabajo relacionado con equipos eléctricos	Los guantes que protegen contra las descargas eléctricas Zapatos aislantes Ropa de protección contra descargas eléctricas
Trabajo en lugares altos (50 cm o más)	Cascos de seguridad de uso industrial
Transporte de objetos pesados	Zapatos con puntera reforzada
Reparación de la unidad exterior	Los guantes que protegen contra las descargas eléctricas

■ Centro de la gravedad

(Unidad: mm)

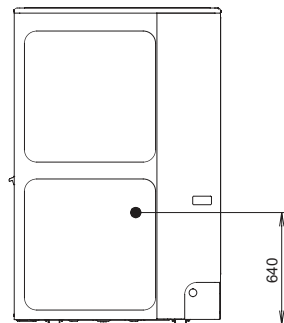
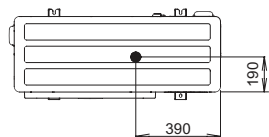

Estas precauciones de seguridad describen cuestiones importantes concernientes a la seguridad a fin de prevenir lesiones a usuarios o a otras personas y daños a la propiedad. Por favor, lea este manual después de entender los siguientes contenidos (significados de las indicaciones) y asegúrese de seguir las instrucciones.





Indicación	Significado de la indicación
ADVERTENCIA	El texto impreso en este formato indica que la omisión de las instrucciones contenidas en la advertencia podría resultar en lesiones corporales graves (*1) o muertes si el producto no se maneja correctamente.
PRECAUCIÓN	El texto impreso en este formato indica que la omisión de las instrucciones contenidas en la precaución podría resultar en lesiones leves (*2) o en daños (*3) a la propiedad si el producto no se maneja correctamente.



*1: Las lesiones corporales graves abarcan pérdida de visión, heridas, quemaduras, descargas eléctricas, fractura de huesos, envenenamiento y otros daños que dejen secuelas y requieran hospitalización o tratamiento ambulatorio prolongados.



*2: Las lesiones leves hacen referencia a heridas, quemaduras, descargas eléctricas y otros daños que no requieran hospitalización ni tratamiento ambulatorio prolongados.

*3: Los daños a la propiedad comprenden daños al edificio, enseres domésticos, animales domésticos o mascotas.

■ **Indicaciones de advertencia en la unidad de aire acondicionado**

	ADVERTENCIA (Riesgo de incendio)	Esta marca está reservada exclusivamente para el refrigerante R32. El tipo de refrigerante aparece escrito en la placa de identificación de la unidad exterior. En caso de que el tipo de refrigerante sea R32, esta unidad utiliza un refrigerante inflamable. Si se producen fugas de refrigerante y este entra en contacto con fuego o con la parte de calefacción, generará gases dañinos y habrá riesgo de incendio.
	Lea atentamente el MANUAL DE USUARIO antes de la operación.	
	El personal de servicio técnico debe leer atentamente el MANUAL DE USUARIO y el MANUAL DE INSTALACIÓN antes de la operación.	
	Hay más información disponible en el MANUAL DE USUARIO, el MANUAL DE INSTALACIÓN y demás documentación.	

Indicación de advertencia	Descripción		
 <table border="1"> <tr> <td>WARNING</td> </tr> <tr> <td>ELECTRICAL SHOCK HAZARD Disconnect all remote electric power supplies before servicing.</td> </tr> </table>	WARNING	ELECTRICAL SHOCK HAZARD Disconnect all remote electric power supplies before servicing.	ADVERTENCIA PELIGRO DE DESCARGA ELÉCTRICA Desconecte todos los suministros eléctricos remotos antes de hacer reparaciones.
WARNING			
ELECTRICAL SHOCK HAZARD Disconnect all remote electric power supplies before servicing.			
 <table border="1"> <tr> <td>WARNING</td> </tr> <tr> <td>Moving parts. Do not operate unit with grille removed. Stop the unit before the servicing.</td> </tr> </table>	WARNING	Moving parts. Do not operate unit with grille removed. Stop the unit before the servicing.	ADVERTENCIA Piezas móviles. No utilice la unidad con la rejilla retirada. Pare la unidad antes de hacer reparaciones.
WARNING			
Moving parts. Do not operate unit with grille removed. Stop the unit before the servicing.			
 <table border="1"> <tr> <td>CAUTION</td> </tr> <tr> <td>High temperature parts. You might get burned when removing this panel.</td> </tr> </table>	CAUTION	High temperature parts. You might get burned when removing this panel.	PRECAUCIÓN Piezas de alta temperatura. Al retirar este panel podría quemarse.
CAUTION			
High temperature parts. You might get burned when removing this panel.			

 <table border="1"> <tr> <td>CAUTION</td> </tr> <tr> <td>Do not touch the aluminum fins of the unit. Doing so may result in injury.</td> </tr> </table>	CAUTION	Do not touch the aluminum fins of the unit. Doing so may result in injury.	PRECAUCIÓN No toque las aletas de aluminio de la unidad. De lo contrario, podrían producirse lesiones personales.
CAUTION			
Do not touch the aluminum fins of the unit. Doing so may result in injury.			
 <table border="1"> <tr> <td>CAUTION</td> </tr> <tr> <td>BURST HAZARD Open the service valves before the operation, otherwise there might be the burst.</td> </tr> </table>	CAUTION	BURST HAZARD Open the service valves before the operation, otherwise there might be the burst.	PRECAUCIÓN PELIGRO DE ROTURA Abra las válvulas de servicio antes de la operación, de lo contrario podrían producirse roturas.
CAUTION			
BURST HAZARD Open the service valves before the operation, otherwise there might be the burst.			

1 PRECAUCIONES DE SEGURIDAD

El fabricante no asume responsabilidad alguna por los daños que resulten de la falta de observación de las descripciones de este manual.

⚠ ADVERTENCIA

Generalidades

- Antes de empezar a instalar el aparato de aire acondicionado, lea atenta y completamente el manual de instalación, y siga sus instrucciones para el instalar aparato de aire acondicionado.
- Sólo un instalador cualificado(*1) o una persona de servicio cualificada(*1) tiene permiso para instalar el aparato de aire acondicionado. Si el aparato de aire acondicionado es instalado por un individuo no cualificado, puede que se produzca un incendio, descargas eléctricas, lesiones, fugas de agua, ruido y/o vibración.
- No utilice ningún refrigerante distinto al especificado para rellenar o reemplazar. De lo contrario, podrá generarse una presión anormalmente alta en el ciclo de refrigeración, lo cual puede producir roturas o explosión, además de lesiones.
- Al transportar la unidad de aire acondicionado, utilice una carretilla elevadora, y al mover el aire acondicionado a mano, mueva la unidad con la ayuda de 4 personas.
- Antes de abrir la rejilla de admisión de la unidad interior o el panel de servicio de la unidad exterior, ponga el disyuntor en la posición OFF. Si no se pone el disyuntor en la posición OFF se puede producir una descarga eléctrica al tomar las piezas interiores. Sólo un instalador cualificado(*1) o una persona de servicio cualificada(*1) tiene permitido retirar la rejilla de admisión de la unidad interior o el panel de servicio de la unidad exterior y hacer el trabajo necesario.
- Antes de realizar la instalación, el trabajo de mantenimiento, reparación o desecho, asegúrese de poner el disyuntor en la posición OFF. De lo contrario se pueden producir descargas eléctricas.

- Ponga un aviso que diga “trabajo en curso” cerca del disyuntor mientras se realiza el trabajo de instalación, mantenimiento, reparación o desecho. Si el disyuntor se pone en ON por error existe el peligro de que se produzcan descargas eléctricas.
- Solo un instalador cualificado(*1) o una persona de mantenimiento cualificada(*1) están autorizados a realizar trabajos en alturas utilizando un soporte de 50 cm o más.
- Póngase guantes de protección y ropa de trabajo segura durante la instalación, reparación y desecho.
- No toque la aleta de aluminio de la unidad exterior. Si lo hace puede lesionarse usted mismo. Si la aleta tiene que tocarse por alguna razón, póngase primero guantes de protección y ropa de trabajo segura, y luego empiece a trabajar.
- No se suba encima ni coloque objetos encima de la unidad exterior. Usted o los objetos podrían caerse de la parte superior de la unidad externa, con el consiguiente riesgo de lesiones.
- Cuando trabaje en lugares altos, use una escalera que cumpla con la norma ISO 14122, y siga las instrucciones de la escalera. Póngase también un casco de uso industrial como equipo de protección para hacer el trabajo.
- Cuando trabaje en un lugar alto, antes de empezar a trabajar, ponga un aviso para que nadie se acerque al lugar de trabajo. Desde la parte superior podrían caer piezas y otros objetos que causarían lesiones a las personas situadas debajo.
- Deberá asegurar que el aparato de aire acondicionado sea transportado de forma estable. Si alguna pieza del producto está rota, póngase en contacto con el distribuidor.
- No modifique los productos. No desmonte ni modifique las piezas. Podría provocar incendios, descargas eléctricas o lesiones.
- El uso de este aparato está destinado a personal especializado o a usuarios con formación para tiendas e industria ligera, o a un uso comercial para el público en general.

Acerca del refrigerante

- Este producto contiene gases fluorinados de efecto invernadero.
- No deje escapar los gases a la atmósfera.
- El aparato se debe almacenar en una habitación sin fuentes de ignición continuamente activas (por ejemplo: llamas expuestas, aparatos de gas en funcionamiento o calentadores eléctricos encendidos).
- No perfore ni queme piezas del circuito de refrigerante.
- No utilice otros medios de acelerar el proceso de descongelación o de limpiar que no sean los recomendados por el fabricante.
- Tenga en cuenta que los refrigerantes pueden no oler a nada.
- El refrigerante en el interior de la unidad es inflamable. Si hay una fuga y el refrigerante pasa a la habitación y entra en contacto con la llama de un quemador, un calentador o una cocina, puede causar un incendio o la formación de gases nocivos.
- Apague todos los calentadores de combustible, ventile la habitación y avise al distribuidor al que compró la unidad.
- No utilice la unidad hasta que el personal del servicio técnico le confirme que la fuga de refrigerante se ha reparado.
- Al instalar, reubicar, o hacer el mantenimiento del aparato de aire acondicionado, utilice exclusivamente el refrigerante especificado (R32) para cargar los conductos de refrigerante. No lo mezcle con ningún otro refrigerante y no permita que quede aire en los tubos.
- Los tubos deben protegerse contra daños físicos.
- Es obligatorio cumplir el reglamento nacional del gas.

Selección del lugar de instalación

- Si instala la unidad en una habitación pequeña, tome las medidas apropiadas para impedir que el refrigerante sobrepase la concentración límite aunque tenga fugas. Consulte al concesionario a quien adquirió el aparato de aire acondicionado cuando ponga en práctica las medidas. La acumulación de refrigerante altamente concentrado puede causar un accidente por falta de oxígeno.

- No instale el aparato de aire acondicionado en un lugar donde pueda estar expuesto a un gas combustible. Si hay fugas de gas combustible y éste se concentra alrededor de la unidad, podría producirse un incendio.
- Al transportar el aparato de aire acondicionado, use calzado con puntera reforzada.
- Cuando transporte el aparato de aire acondicionado, no lo tome por las bandas de alrededor del cartón de embalaje. Usted podría lesionarse si se rompieran las bandas.
- No ponga ningún aparato de combustión en un lugar expuesto directamente al aire procedente del aparato de aire acondicionado, de lo contrario, la combustión no sería perfecta.
- No instale el aparato de aire acondicionado en espacios mal ventilados que sean más pequeños que la superficie de suelo mínima (A_{min}).
Esto es aplicable a:
 - Unidades interiores
 - Unidades exteriores instaladas (ejemplos: jardín de invierno, garaje, taller, etc.)Consulte “15 APÉNDICE - [2] Superficie de suelo mínima: A_{min} (m^2)” para determinar la superficie de suelo mínima.

Instalación

- Instale el aparato de aire acondicionado en lugares suficientemente fuertes que puedan aguantar el peso de la unidad. Si la resistencia no es suficiente, la unidad puede caerse y causar lesiones.
- Siga las instrucciones del manual de instalación para instalar el aparato de aire acondicionado. Si no se cumplen estas instrucciones el producto podrá caer o volcar, o producir ruido, vibración, fugas de agua, etc.
- Cuando se instale la unidad exterior deberán usarse los pernos (M10) y las tuercas (M10) designados para asegurarla.

- Instale correctamente la unidad exterior en un lugar que sea lo suficientemente duradero como para aguantar su peso. Una resistencia insuficiente puede provocar la caída de la unidad exterior y posibles lesiones.
- Si se producen fugas de gas refrigerante durante la instalación, ventile inmediatamente la habitación. Si el gas refrigerante liberado durante la fuga entra en contacto con fuego, pueden generarse gases tóxicos.
- La instalación de tuberías se limitará al mínimo posible.

Tubería de refrigerante

- Instale firmemente el tubo del refrigerante durante los trabajos de instalación antes de poner en funcionamiento el aparato de aire acondicionado. Si el compresor funciona con su válvula abierta y sin tubo de refrigerante, el compresor succionará aire y los ciclos de refrigeración tendrán una presión excesiva, lo que puede causar lesiones.
- Apriete la tuerca abocinada con una llave de ajuste dinamométrica como se indica. Un apriete excesivo de tuerca abocinada puede causar grietas en la misma después de pasar mucho tiempo, lo que podría causar fugas de refrigerante.
- Para las labores de instalación y reubicación, siga las instrucciones del Manual de Instalación y utilice herramientas y piezas de tubo específicamente fabricadas para su uso con el refrigerante R32. Si se utilizan piezas de tubo no diseñadas para el refrigerante R32 y la unidad no está correctamente instalada, los tubos podrían reventar y causar daños o lesiones. Además podrían producirse fugas de agua, descargas eléctricas o incendios.
- Para la prueba de hermeticidad al aire deberá usarse nitrógeno.
- La manguera de carga deberá conectarse de forma que no esté floja.

Cableado eléctrico

- Sólo un instalador cualificado(*1) o una persona de servicio cualificada(*1) tiene permitido realizar el trabajo eléctrico del aparato de aire acondicionado. Este trabajo no deberá hacerlo, bajo ninguna circunstancia, un individuo que no esté cualificado, porque si el trabajo se hace mal, existe el peligro de que se produzcan descargas eléctricas y/o fugas eléctricas.
- La instalación del aparato debe realizarse en conformidad con las normas nacionales de cableado. La falta de capacidad de un circuito eléctrico o una instalación incorrecta pueden provocar una descarga eléctrica o un incendio.
- Use cables que cumplan con las especificaciones del manual de instalación y las estipulaciones de las normas y leyes locales. El uso de cables que no cumplen con las especificaciones puede dar origen a descargas eléctricas, fugas eléctricas, humo y/o incendios.
- Asegúrese de conectar el cable de tierra (toma de tierra). La conexión a tierra incompleta puede causar descargas eléctricas.
- No conecte los cables de toma a tierra a tubos de gas, tubos de agua, pararrayos o cables de toma a tierra de teléfonos.
- Después de completar el trabajo de reparación y recolocación, verifique que los cables de toma a tierra estén bien conectados.
- Instale un disyuntor que cumpla con las especificaciones del manual de instalación y con las estipulaciones de las normas y las leyes locales.
- Instale el disyuntor donde el agente pueda tener acceso a él fácilmente.
- Cuando instale el disyuntor en el exterior, instale uno diseñado para ser usado en exteriores.
- El cable no deberá alargarse bajo ninguna circunstancia. Los problemas de conexión en lugares donde el cable se extiende pueden producir humo y/o un incendio.

Prueba de funcionamiento

- Antes de utilizar el aparato de aire acondicionado después de completar el trabajo de instalación, verifique que la cubierta de la caja de componentes eléctricos de la unidad interior y del panel de servicio de la unidad exterior esté cerrada, y ponga el disyuntor en la posición ON. Si conecta la alimentación sin realizar primero estas verificaciones, puede recibir una descarga eléctrica o producirse otras lesiones.
- Cuando note algún tipo de problema en el aparato de aire acondicionado (por ejemplo, cuando aparece una visualización de comprobación, hay olor a quemado, se oyen ruidos anormales, el aparato de aire acondicionado no refrigera ni calienta o hay fugas de agua), no lo toque, ponga antes el disyuntor en la posición OFF y póngase en contacto con una persona de mantenimiento cualificada. Tome medidas (poniendo un aviso de “fuera de servicio” cerca del disyuntor, por ejemplo) para asegurar que la alimentación no se conecte antes de que llegue la persona de servicio cualificada. Continuar usando el aparato de aire acondicionado teniendo éstos fallos puede causar un empeoramiento de los problemas mecánicos o causar descargas eléctricas, etc.
- Después de terminar el trabajo, asegúrese de usar el verificador de aislamiento (500 VMΩ) para verificar que la resistencia sea de 1 MΩ o más entre la sección de carga y la sección de metal de no carga (sección de tierra). Si el valor de la resistencia es bajo, esto se debe a un fallo como, por ejemplo, una fuga o una descarga eléctrica en el lado del usuario.
- Al completar el trabajo de instalación, verifique que no haya fugas de refrigerante, y también la resistencia del aislamiento y el drenaje de agua. Luego haga una prueba de funcionamiento para verificar si el aparato de aire acondicionado funciona correctamente.
- Tras la instalación, asegúrese de que no existen fugas de gas refrigerante. Si se produce una fuga de gas refrigerante en la habitación y hay una fuente de fuego próxima, como una cocina, podría generarse gas nocivo.

Explicaciones para dar al usuario

- Al finalizar el trabajo de instalación dígame al usuario dónde está situado el disyuntor. Si el usuario no sabe dónde está el disyuntor, él o ella no podrán desconectar la alimentación en el caso de que se produzca un fallo en el aparato de aire acondicionado.
- Si detecta que la rejilla del ventilador está dañada, no se acerque a la unidad exterior, desconecte el disyuntor, y póngase en contacto con una persona de mantenimiento cualificada(*1) para que realice las reparaciones. No ponga el disyuntor en la posición ON hasta después de terminar las reparaciones.
- Después de hacer el trabajo de instalación, siga las indicaciones del manual del propietario para explicar al cliente cómo usar y mantener la unidad.

Recolocación

- Sólo un instalador cualificado(*1) o una persona de servicio cualificada(*1) tiene permiso para recolocar el aparato de aire acondicionado. Es peligroso para el aparato de aire acondicionado que sea recolocado por un individuo no cualificado, porque se puede producir un incendio, descargas eléctricas, lesiones, fugas de agua, ruido y/o vibración.
- Cuando realice trabajos de bombeo de vacío, cierre el compresor antes de desconectar el tubo del refrigerante. Si se desconecta el tubo del refrigerante con la válvula de servicio abierta y con el compresor todavía en funcionamiento, se provocará la succión de aire, etc., elevando la presión dentro del ciclo de refrigeración hasta un nivel anormalmente alto, lo que podría provocar roturas, lesiones, etc.

(*1) Consulte la “definición de instalador cualificado o persona de servicio cualificada”.

⚠ PRECAUCIÓN

Este aparato de aire acondicionado utiliza el refrigerante HFC (R32) que no destruye la capa de ozono

- El refrigerante R32 posee una alta presión de trabajo y es susceptible de verse afectado por impurezas tales como agua, membrana oxidante y aceites. Por tanto, durante las labores de instalación tenga cuidado de que no entre agua, polvo, refrigerante anterior, aceite de la máquina de refrigeración u otras sustancias en el circuito de refrigeración R32.
- Para la instalación hacen falta herramientas especiales para el refrigerante R32 o R410A.
- Para conectar los tubos, utilice materiales de tubería nuevos y limpios, y asegúrese de que no les entre ni agua ni polvo.

Precauciones acerca del espacio de instalación de la unidad exterior

- En caso de que la unidad exterior esté instalada en un espacio pequeño y de que haya una fuga de refrigerante, la acumulación de refrigerante muy concentrado implica un riesgo de incendio. Por tanto, asegúrese de seguir las instrucciones en cuanto al espacio de instalación requerido que figuran en el Manual de Instalación, y habilite un espacio abierto en al menos uno de los cuatro costados de la unidad exterior.

- En particular, cuando tanto los costados de descarga y entrada se hallen frente a paredes y también haya obstáculos a ambos lados de la unidad exterior, tome medidas para abrir un espacio lo suficientemente amplio para que pase una persona (600 mm o más) por uno de los lados, a fin de prevenir la acumulación del refrigerante fugado.

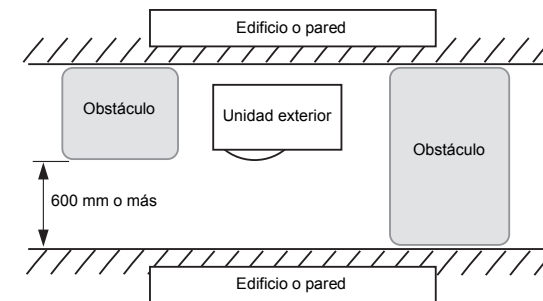

Para desconectar el dispositivo de la fuente de alimentación

- Este aparato se debe conectar a la fuente de alimentación principal mediante un interruptor con una separación de contactos de 3 mm, como mínimo.

No lave aparatos de aire acondicionado con máquinas de lavado a presión.

- Las fugas de electricidad pueden causar descargas eléctricas o incendios.

Obrigado por ter adquirido este ar condicionado da Toshiba.

Leia cuidadosamente estas instruções incluindo as informações importantes conformes com a Diretiva relativa às máquinas (Diretiva 2006/42/CE) e certifique-se de que as compreende.

Depois de ler estas instruções, certifique-se de que as guarda juntamente com o Manual do Proprietário e o Manual de Instalação fornecidos com o produto.

Denominação Genérica: Ar Condicionado

Definição de Instalador Qualificado ou de Técnico de Assistência Qualificado

O ar condicionado deve ser instalado, mantido, reparado e eliminado por um instalador qualificado ou um técnico de assistência qualificado. Quando for necessário efectuar qualquer um destes trabalhos, peça a um instalador qualificado ou a um técnico de assistência qualificado para efectuar estes trabalhos.

Um instalador qualificado ou um técnico de assistência qualificado é um agente com as qualificações e os conhecimentos descritos na tabela abaixo.

Agente	Qualificações e conhecimentos necessários do agente
Instalador qualificado	<ul style="list-style-type: none">• O instalador qualificado é uma pessoa que instala, mantém, muda e elimina os aparelhos de ar condicionado fabricados pela Toshiba Carrier Corporation. O instalador qualificado teve formação para instalar, manter, mudar e eliminar os aparelhos de ar condicionado fabricados pela Toshiba Carrier Corporation ou, alternativamente, recebeu instruções relacionadas com estas operações de pessoas que tiveram formação e, por conseguinte, têm conhecimentos relacionados com estas operações.• O instalador qualificado e autorizado para efectuar o trabalho eléctrico envolvido na instalação, mudança e eliminação tem as qualificações adequadas para este trabalho eléctrico conforme estipulado pelos regulamentos e as leis locais, e é uma pessoa que teve formação relacionada com o trabalho eléctrico dos aparelhos de ar condicionado fabricados pela Toshiba Carrier Corporation ou, alternativamente, recebeu instruções relacionadas com estas operações de pessoas que tiveram formação e, por conseguinte, têm conhecimentos relacionados com estas operações.• O instalador qualificado e autorizado para efectuar os trabalhos de instalação de tubagens e manuseamento do refrigerante envolvidos na instalação, mudança e eliminação tem as qualificações adequadas para o trabalho de instalação das tubagens e o manuseamento do refrigerante conforme estipulado pelos regulamentos e as leis locais, e é uma pessoa que teve formação relacionada com o trabalho de instalação de tubagens e manuseamento do refrigerante dos equipamentos de ar condicionado fabricados pela Toshiba Carrier Corporation ou, alternativamente, recebeu instruções relacionadas com estas operações de pessoas que tiveram formação e, por conseguinte, têm conhecimentos relacionados com este trabalho.• O instalador qualificado e autorizado para trabalhar em altura teve formação em matérias relacionadas com o trabalho em altura com os aparelhos de ar condicionado fabricados pela Toshiba Carrier Corporation ou, alternativamente, recebeu instruções relacionadas com estas operações de pessoas que tiveram formação e, por conseguinte, têm conhecimentos relacionados com este trabalho.

Técnico de assistência qualificado	<ul style="list-style-type: none">• O técnico de assistência qualificado é uma pessoa que instala, repara, mantém, muda e elimina os aparelhos de ar condicionado fabricados pela Toshiba Carrier Corporation. O técnico de assistência qualificado teve formação para instalar, reparar, manter, mudar e eliminar os aparelhos de ar condicionado fabricados pela Toshiba Carrier Corporation ou, alternativamente, recebeu instruções relacionadas com estas operações de pessoas que tiveram formação e, por conseguinte, têm conhecimentos relacionados com estas operações.• O técnico de assistência qualificado e autorizado para efectuar o trabalho eléctrico envolvido na instalação, reparação, mudança e eliminação tem as qualificações adequadas para este trabalho eléctrico conforme estipulado pelos regulamentos e as leis locais, e é uma pessoa que teve formação relacionada com o trabalho eléctrico dos aparelhos de ar condicionado fabricados pela Toshiba Carrier Corporation ou, alternativamente, recebeu instruções relacionadas com estas operações de pessoas que tiveram formação e, por conseguinte, têm conhecimentos relacionados com estas operações.• O técnico de assistência qualificado e autorizado para efectuar os trabalhos de instalação de tubagens e manuseamento do refrigerante envolvidos na instalação, reparação, mudança e eliminação tem as qualificações adequadas para o trabalho de instalação das tubagens e o manuseamento do refrigerante conforme estipulado pelos regulamentos e as leis locais, e é uma pessoa que teve a formação relacionada com o trabalho de instalação de tubagens e manuseamento do refrigerante dos aparelhos de ar condicionado fabricados pela Toshiba Carrier Corporation ou, alternativamente, recebeu instruções relacionadas com estas operações de pessoas que tiveram formação e, por conseguinte, têm conhecimentos relacionados com este trabalho.• O técnico de assistência qualificado e autorizado para trabalhar em altura teve formação em matérias relacionadas com o trabalho em altura com os aparelhos de ar condicionado fabricados pela Toshiba Carrier Corporation ou, alternativamente, o técnico de assistência qualificado recebeu instruções relacionadas com estas operações de pessoas que tiveram formação e, por conseguinte, têm conhecimentos relacionados com este trabalho.
------------------------------------	--

Definição do Equipamento de Protecção

Quando transportar, instalar, manter, reparar ou eliminar o ar condicionado, use luvas de protecção e vestuário de trabalho de segurança.

Além deste equipamento de protecção normal, use o equipamento de protecção descrito abaixo quando efectuar o trabalho especial descrito detalhadamente na tabela abaixo.

A não utilização do equipamento de protecção adequado é perigoso porque fica mais susceptível a lesões, queimaduras, choques eléctricos e outras lesões.

Trabalho efectuado	Equipamento de protecção usado
Todos os tipos de trabalhos	Luvas de protecção Vestuário de trabalho de segurança
Trabalho eléctrico	Luvas para proteger contra choques eléctricos Sapatos isoladores Vestuário para proteger contra choques eléctricos
Trabalho efectuado em alturas (50 cm ou mais)	Capacetes industriais
Transporte de objectos pesados	Sapatos com protecção adicional para os dedos dos pés
Reparação da unidade exterior	Luvas para proteger contra choques eléctricos

■ Centro de gravidade

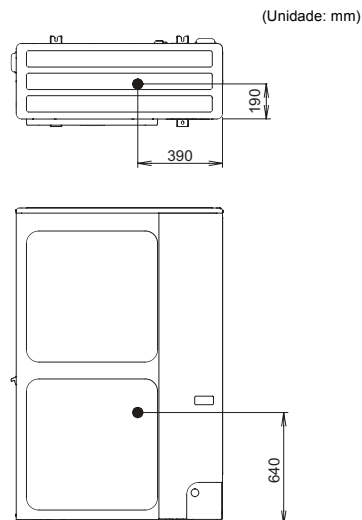

Estas precauções de segurança descrevem questões importantes em matéria de segurança para prevenir lesões aos utilizadores ou outras pessoas e danos materiais. Por favor leia este manual após compreender o conteúdo abaixo (significados das indicações) e certifique-se de que segue a descrição.





Indicação	Significado da indicação
AVISO	O texto realçado desta forma indica que o não seguimento das instruções no aviso pode resultar em danos corporais graves (*1) ou perda de vida, se o produto for manuseado incorretamente.
ATENÇÃO	O texto realçado desta forma indica que o não seguimento das instruções na chamada de atenção pode resultar em ferimentos ligeiros (*2) ou danos (*3) materiais, se o produto for manuseado incorretamente.



*1: Danos corporais graves referem-se a perda de visão, ferimentos, queimaduras, choque eléctrico, fraturas ósseas, envenenamento e outros ferimentos que deixam sequelas e requerem hospitalização ou tratamento prolongado em regime de ambulatório.



*2: Ferimentos ligeiros referem-se a ferimentos, queimaduras, choque eléctrico e outros ferimentos que não requerem hospitalização ou tratamento prolongado em regime de ambulatório.

*3: Danos materiais referem-se a danos extensos a edifícios, objetos de uso doméstico, animais domésticos e animais de estimação.

■ Indicações de Aviso sobre o Ar Condicionado

	AVISO (Risco de incêndio)	Esta marca é apenas para o refrigerante R32. O tipo de refrigerante está escrito na placa de identificação da unidade exterior. No caso de o tipo de refrigerante ser R32, esta unidade utiliza um refrigerante inflamável. Em caso de fugas do refrigerante e entrar em contacto com o fogo ou peça de aquecimento, poderá criar gás nocivo e existe risco de incêndio.
		Leia cuidadosamente o MANUAL DO PROPRIETÁRIO antes da operação.
		Os técnicos de assistência são obrigados a ler cuidadosamente o MANUAL DO PROPRIETÁRIO e MANUAL DE INSTALAÇÃO antes da operação.
		Estão disponíveis mais informações no MANUAL DO PROPRIETÁRIO, MANUAL DE INSTALAÇÃO e similares.

Indicação de aviso	Descrição		
 <table border="1"> <tr> <td>WARNING</td> </tr> <tr> <td>ELECTRICAL SHOCK HAZARD Disconnect all remote electric power supplies before servicing.</td> </tr> </table>	WARNING	ELECTRICAL SHOCK HAZARD Disconnect all remote electric power supplies before servicing.	AVISO PERIGO DE CHOQUE ELÉCTRICO Desligue todas as fontes de alimentação eléctrica remotas antes de uma operação de assistência.
WARNING			
ELECTRICAL SHOCK HAZARD Disconnect all remote electric power supplies before servicing.			
 <table border="1"> <tr> <td>WARNING</td> </tr> <tr> <td>Moving parts. Do not operate unit with grille removed. Stop the unit before the servicing.</td> </tr> </table>	WARNING	Moving parts. Do not operate unit with grille removed. Stop the unit before the servicing.	AVISO Peças rotativas. Não utilize a unidade com a grelha retirada. Pare a unidade antes de uma operação de assistência.
WARNING			
Moving parts. Do not operate unit with grille removed. Stop the unit before the servicing.			
 <table border="1"> <tr> <td>CAUTION</td> </tr> <tr> <td>High temperature parts. You might get burned when removing this panel.</td> </tr> </table>	CAUTION	High temperature parts. You might get burned when removing this panel.	ATENÇÃO Peças com elevadas temperaturas. Pode queimar-se quando retirar este painel.
CAUTION			
High temperature parts. You might get burned when removing this panel.			

 <table border="1"> <tr> <td>CAUTION</td> </tr> <tr> <td>Do not touch the aluminum fins of the unit. Doing so may result in injury.</td> </tr> </table>	CAUTION	Do not touch the aluminum fins of the unit. Doing so may result in injury.	ATENÇÃO Não toque nas palhetas de alumínio da unidade. Caso contrário, poderá ferir-se.
CAUTION			
Do not touch the aluminum fins of the unit. Doing so may result in injury.			
 <table border="1"> <tr> <td>CAUTION</td> </tr> <tr> <td>BURST HAZARD Open the service valves before the operation, otherwise there might be the burst.</td> </tr> </table>	CAUTION	BURST HAZARD Open the service valves before the operation, otherwise there might be the burst.	ATENÇÃO PERIGO DE EXPLOÇÃO Abra as válvulas de serviço antes de utilizar o equipamento, caso contrário, pode ocorrer uma explosão.
CAUTION			
BURST HAZARD Open the service valves before the operation, otherwise there might be the burst.			

1 PRECAUÇÕES DE SEGURANÇA

O fabricante não assumirá nenhuma responsabilidade por danos causados pela não observação das descrições dadas neste manual.

⚠ AVISO

Geral

- Antes de instalar o ar condicionado, leia cuidadosamente o Manual de Instalação e siga as instruções fornecidas para instalar o ar condicionado.
- Apenas um instalador qualificado(*1) ou um técnico de assistência qualificado(*1) pode instalar o ar condicionado. Se o ar condicionado for instalado por uma pessoa não qualificada, pode ocorrer um incêndio, choques eléctricos, lesões, fugas de água, ruídos e/ou vibrações.
- Não utilize um refrigerante diferente do especificado para complementação ou substituição. Caso contrário, uma pressão anormalmente alta pode ser gerada no ciclo de refrigeração, o que pode causar uma falha ou explosão do produto ou ferimentos.
- Quando transportar o aparelho de ar condicionado, utilize um empilhador, e quando mover o aparelho de ar condicionado manualmente, mova-o com 4 pessoas.
- Antes de abrir a grelha de entrada da unidade interior ou painel de serviço da unidade exterior, coloque o disjuntor eléctrico na posição OFF. A não colocação do disjuntor eléctrico na posição OFF pode provocar choques eléctricos devido ao contacto com as peças internas. Apenas um instalador qualificado(*1) ou um técnico de assistência qualificado(*1) pode retirar a grelha de entrada da unidade interior ou o painel de serviço da unidade exterior e efectuar os trabalhos necessários.

- Antes de efectuar o trabalho de instalação, manutenção, reparação ou de eliminação, certifique-se de que coloca o disjuntor eléctrico na posição OFF. Caso contrário, podem ocorrer choques eléctricos.
- Coloque um sinal “Trabalho em progresso” junto ao disjuntor eléctrico durante a realização de trabalhos de instalação, manutenção, reparação ou eliminação. Existe um perigo de choques eléctricos se colocar o disjuntor eléctrico na posição ON por engano.
- Apenas um instalador qualificado(*1) ou um técnico de assistência qualificado(*1) pode efectuar o trabalho em altura utilizando um suporte de 50 cm ou mais.
- Use luvas de protecção e vestuário de trabalho de segurança durante a instalação, a assistência e a eliminação.
- Não toque na palheta de alumínio da unidade exterior. Pode ferir-se, se o fizer. Se for necessário tocar na palheta por algum motivo, coloque primeiro as luvas de protecção e o vestuário de trabalho de segurança e, em seguida, prossiga.
- Não suba para nem coloque objectos sobre a unidade exterior. Pode cair ou os objetos podem cair de cima da unidade exterior e provocar ferimentos.
- Quando trabalhar em altura, utilize uma escada em conformidade com a norma ISO 14122 e efectue o procedimento descrito nas instruções da escada. Use também um capacete industrial como equipamento de protecção para efectuar o trabalho.
- Quando trabalhar em altura, coloque um sinal no local para que ninguém se aproxime do local de trabalho antes de continuar com o trabalho. As peças e outros objectos podem cair da parte superior, ferindo possivelmente uma pessoa que esteja por baixo.
- Certifique-se de que o ar condicionado é transportado de uma forma estável. Se qualquer parte do produto estiver partida, contacte o revendedor.

- Não modifique os produtos. Não desmonte nem modifique as peças. Isso pode resultar num incêndio, choque eléctrico ou lesão física.
- Este aparelho destina-se à utilização por parte de especialistas ou utilizadores com formação em oficinas, em indústria ligeira ou para uso comercial por leigos.

Sobre o refrigerante

- Este produto contém gases fluorados com efeito de estufa.
- Não evacue os gases para a atmosfera.
- O aparelho deve ser armazenado numa sala sem fontes de ignição a funcionar continuamente (por exemplo: chamas abertas, um aparelho a gás ou um aquecedor eléctrico).
- Não perfure nem queime as peças do ciclo de refrigeração.
- Não utilize meios para acelerar o processo de descongelamento ou para limpar, a não ser aqueles recomendados pelo fabricante.
- Saiba que os refrigerantes podem ser inodoros.
- O refrigerante no interior da unidade é inflamável. Se ocorrer fuga de refrigerante na sala e entrar em contacto com fogo de um queimador, um aquecedor, ou um fogão, pode resultar em incêndio ou na formação de um gás nocivo.
- Desligue os dispositivos de aquecimento combustíveis, ventile a sala e contacte o revendedor a quem adquiriu a unidade.
- Não utilize a unidade até um técnico de assistência confirmar que a parte da qual o refrigerante escapou é reparada.
- Quando instalar, realocar ou efetuar manutenção ao ar condicionado, utilize somente o refrigerante especificado (R32) para carregar as linhas de refrigeração. Não misture com qualquer outro refrigerante e não deixe que o ar permaneça nas linhas.
- A canalização deve ser protegida de danos físicos.
- Deve-se observar o cumprimento dos regulamentos nacionais relativos ao gás.

Seleção do local de instalação

- Se instalar a unidade numa sala pequena, tome as medidas adequadas para evitar que o refrigerante exceda o limite de concentração mesmo em caso de derrame. Consulte o revendedor a quem adquiriu o ar condicionado quando implementar as medidas. A acumulação de refrigerante altamente concentrado pode provocar um acidente devido à falta de oxigénio.
- Não instale o ar condicionado num local sujeito a um risco de expiração de um gás combustível. Se ocorrer uma fuga de um gás combustível que se concentre à volta da unidade, pode ocorrer um incêndio.
- Quando transportar o ar condicionado, use sapatos com proteção adicional para os dedos dos pés.
- Quando transportar o ar condicionado, não segure nas faixas existentes à volta da embalagem de cartão. Pode ferir-se, se as faixas se partirem.
- Não coloque nenhum aparelho de combustão num local exposto directamente ao vento do ar condicionado, caso contrário, pode provocar uma combustão imperfeita.
- Não instale o ar condicionado num espaço mal ventilado que seja mais pequeno que a área mínima do piso (A_{min}).
Isto aplica-se a:
 - Unidades interiores
 - Unidades exteriores instaladas
(exemplo: jardim de inverno, garagem, sala de máquinas, etc.)Consulte o “APÊNDICE 15 - [2] Área mínima do piso: A_{min} (m²)” para determinar a área mínima do piso.

Instalação

- Instale o ar condicionado em locais suficientemente fortes para suportar o peso da unidade. Se a força não for suficiente, a unidade pode cair e provocar lesões.
- Siga as instruções fornecidas no Manual de Instalação para instalar o ar condicionado. O incumprimento destas instruções pode provocar a queda do produto ou originar ruído, vibração, fuga de água, etc.
- Tem de utilizar os parafusos (M10) e as porcas (M10) para fixar a unidade exterior quando instalar a unidade.
- Instale a unidade exterior num local suficientemente forte para suportar o peso da unidade exterior. Uma capacidade de suporte insuficiente pode fazer com que a unidade exterior caia e provocar ferimentos.
- Se o gás refrigerante vazar durante o trabalho de instalação, ventile o ambiente imediatamente. Se o gás refrigerante que escapou entrar em contacto com fogo, poderá dar origem a gás tóxico.
- A instalação da canalização deve ser mantida a um mínimo.

Tubagem de refrigerante

- Instale correctamente o tubo de refrigeração durante a instalação antes de colocar o ar condicionado em funcionamento. Se operar o compressor com a válvula aberta e sem o tubo de refrigerante, o compressor suga o ar e os ciclos de refrigeração ficam sobreprensionados, esta situação pode provocar uma lesão.
- Aperte a porca de alargamento com uma chave dinamométrica e da forma especificada. O aperto excessivo da porca de alargamento pode provocar uma racha na porca de alargamento após um longo período, que pode resultar na fuga de refrigerante.

- Para trabalhos de instalação e realocização, siga as instruções no Manual de Instalação e utilize ferramentas e componentes de tubos especificamente fabricados para utilizar com o refrigerante R32. Se utilizar componentes de tubos não concebidos para o refrigerante R32 e a unidade não for instalada correctamente, os tubos podem rebentar e causar danos ou ferimentos. Além disso, daí pode resultar a fuga de água, choque eléctrico ou incêndio.
- Tem de utilizar gás de nitrogénio para o teste de impermeabilidade.
- Tem de ligar o tubo de carga para que não exista nenhuma folga.

Ligações eléctricas

- Apenas um instalador qualificado(*1) ou um técnico de assistência qualificado(*1) pode efectuar o trabalho eléctrico do ar condicionado. Este trabalho não deve ser efectuado por uma pessoa não qualificada em nenhuma circunstância porque um trabalho executado incorrectamente pode resultar em choques eléctricos e/ou fugas eléctricas.
- O aparelho deve ser instalado em conformidade com os regulamentos nacionais relativos a instalações eléctricas. Se o circuito de alimentação não tiver capacidade suficiente ou a instalação ficar incompleta, podem ocorrer choques eléctricos ou incêndios.
- Utilize cablagens que cumpram as especificações fornecidas no Manual de Instalação e as condições nas leis e regulamentos locais. A utilização de cablagens que não cumpram as especificações pode originar choques eléctricos, fugas eléctricas, fumo e/ou um incêndio.
- Não se esqueça de efectuar a ligação à massa (trabalho de ligação à terra).
A ligação à massa incompleta provoca um choque eléctrico.
- Não ligue os fios de ligação à massa a tubos de gás, tubos de água, pára-raios ou fios de ligação à massa de fios telefónicos.

- Depois de concluir o trabalho de reparação ou mudança, verifique se os fios de ligação à massa estão ligados correctamente.
- Instale um disjuntor eléctrico que cumpra as especificações fornecidas no manual de instalação e as condições nas leis e regulamentos locais.
- Instale o disjuntor eléctrico num local de fácil acesso ao agente.
- Quando instalar um disjuntor eléctrico no exterior, instale um disjuntor concebido para utilizar no exterior.
- Não deve ampliar o cabo de alimentação em nenhuma circunstância. O problema da ligação em locais em que o cabo é ampliado pode originar fumo e/ou um incêndio.

Teste de funcionamento

- Antes de utilizar o ar condicionado após a conclusão do trabalho, verifique se a tampa da caixa do equipamento eléctrico da unidade interior e o painel de serviço da unidade exterior estão fechados e coloque o disjuntor eléctrico na posição ON. Pode sofrer um choque eléctrico etc. se ligar a corrente eléctrica sem efectuar primeiro estas verificações.
- Quando detetar algum tipo de problema (como, por exemplo, quando aparecer o visor de verificação, existir um cheiro a queimado, ouvir sons anormais, o ar condicionado não arrefecer ou aquecer, ou existir uma fuga de água) no ar condicionado, não toque no ar condicionado, coloque o disjuntor eléctrico na posição OFF e contacte um técnico de assistência qualificado. Tome as medidas necessárias para garantir que a corrente eléctrica não será ligada (através da colocação do aviso “fora de serviço” junto ao disjuntor de serviço, por exemplo) até chegar o técnico de assistência qualificado. Se continuar a utilizar o ar condicionado com problemas, pode provocar o aumento dos problemas mecânicos ou choques eléctricos, etc.

- Depois de terminar o trabalho, certifique-se de que utiliza um aparelho de verificação do isolamento (500 VMΩ) para verificar se a resistência é 1 MΩ ou mais entre a secção de carga e a secção metálica sem carga (Secção de ligação à terra). Se o valor da resistência for baixo, ocorre uma fuga ou um choque eléctrico no lado do utilizador.
- Depois de concluir o trabalho de instalação, verifique se existem fugas de refrigerante, a resistência do isolamento e a drenagem de água. Realize um teste para verificar se o ar condicionado está a funcionar correctamente.
- Após o trabalho de instalação, confirme que não haja nenhuma fuga do gás refrigerante. Se houver uma fuga de gás refrigerante para o compartimento que entre em contacto com uma chama, por exemplo, no caso de um fogão, poderá gerar gás tóxico.

Explicações fornecidas ao utilizador

- Depois de concluir o trabalho de instalação, indique o local de instalação do disjuntor eléctrico ao utilizador. Se o utilizador não souber a localização do disjuntor eléctrico, não será capaz de o desligar no caso de ocorrer um problema no ar condicionado.
- Se descobrir que o protetor da ventoinha está danificado, não se aproxime da unidade exterior, mas coloque o disjuntor na posição OFF e contacte um técnico de assistência qualificado(*1) para proceder à reparação. Não coloque o disjuntor eléctrico na posição ON até ao fim das reparações.
- Depois de concluir o trabalho de instalação, utilize o Manual do Proprietário para explicar ao cliente como utilizar e manter a unidade.

Mudança

- Apenas um instalador qualificado(*1) ou um técnico de assistência qualificado(*1) pode mudar o ar condicionado. É perigoso o ar condicionado ser mudado por uma pessoa não qualificada porque pode ocorrer um incêndio, choques eléctricos, lesões, fugas de água, ruídos e/ou vibrações.
- Quando efectuar o trabalho de bombagem, encerre o compressor antes de desligar o tubo de refrigerante. Se desligar o tubo de refrigerante com a válvula de serviço aberta e o compressor em funcionamento, provocará a sucção do ar, etc., o aumento da pressão no ciclo de refrigeração para um nível elevado anormal e resultando possivelmente em lesões, recolocação, etc.

(*1) Consulte a "Definição de Instalador Qualificado ou Técnico de Instalação Qualificado".

⚠ ATENÇÃO

Este ar condicionado adota o refrigerante HFC (R32) que não destrói a camada de ozono

- O refrigerante R32 tem uma elevada pressão de trabalho e é suscetível de ser afetado por impurezas como água, membrana de oxidação e óleos. Por conseguinte, durante os trabalhos de instalação, tome cuidado para que a água, a poeira, o refrigerante anterior, o óleo de refrigeração da máquina, ou outras substâncias não entrem no ciclo de refrigeração R32.
- Para a instalação, são necessárias ferramentas especiais para o refrigerante R32 ou R410A.
- Para os tubos de ligação, utilize tubagens novas e limpas, e certifique-se de que a água e/ou poeira não entram.

Cuidados a ter no espaço de instalação da unidade exterior

- No caso de a unidade exterior ser instalada num espaço pequeno e ocorrer fuga de refrigerante, a acumulação de refrigerante altamente concentrado pode causar um perigo de incêndio. Por conseguinte, certifique-se de que segue as instruções para o espaço de instalação no Manual de Instalação, e disponibiliza espaço aberto em pelo menos um dos quatro lados da unidade exterior.
- Em particular, quando ambos os lados de descarga e admissão estão virados para paredes e existem obstáculos em ambos os lados da unidade exterior, tome medidas para disponibilizar espaço suficiente para uma pessoa passar (600 mm ou mais) num lado para evitar a acumulação de refrigerante que escapou.

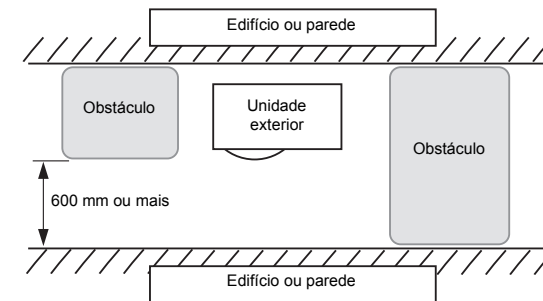

Para desligar o aparelho do fornecimento de energia principal

- Este aparelho deve ser conectado ao fornecimento de energia principal através dum interruptor com uma separação de contacto de pelo menos 3 mm.

Não lave os aparelhos de ar condicionado com uma máquina de lavagem a pressão.

- As fugas eléctricas podem provocar choques eléctricos ou incêndios.

Hartelijk dank voor uw aankoop van deze Toshiba airconditioner.

Lees deze instructies aandachtig door, evenals de belangrijke informatie die voldoet aan de "Machinerichtlijn" (richtlijn 2006/42/EG) en zorg dat u deze instructies begrijpt.

Na het doorlezen van deze instructies dient u ze te bewaren op een veilige plaats, samen met de eigenaarshandleiding en de installatiehandleiding die bij uw product zijn geleverd.

Algemene beschrijving: Airconditioner

Definitie van bevoegd installateur of bevoegd onderhoudsmonteur

De airconditioner moet worden geïnstalleerd, onderhouden, gerepareerd en uiteindelijk weggedaan door een bevoegd installateur of bevoegd onderhoudsmonteur. Wanneer een van deze taken verricht moet worden, verzoekt u dan een bevoegd installateur of bevoegd onderhoudsmonteur om dit voor u te doen.

Een bevoegd installateur of bevoegd onderhoudsmonteur is een persoon die beschikt over de kennis en bevoegdheden die staan vermeld in de onderstaande tabel.

Persoon	Kennis en bevoegdheden waarover de persoon moet beschikken
Bevoegd installateur	<ul style="list-style-type: none"> Een bevoegd installateur is een persoon die zorgt voor de installatie, het onderhoud, het verplaatsen en wegdoen van de airconditioners vervaardigd door de Toshiba Carrier Corporation. Hij of zij is opgeleid voor de installatie, het onderhoud, het verplaatsen en wegdoen van de airconditioners vervaardigd door de Toshiba Carrier Corporation, of anders is hij of zij geïnstrueerd in dergelijke ingrepen door een persoon of personen die daarvoor zijn opgeleid, en beschikt als zodanig over alle vereiste kennis voor deze ingrepen. De bevoegd installateur die kan worden toegestaan de vereiste elektrische ingrepen te verrichten voor de installatie, het verplaatsen en het wegdoen, beschikt over de bevoegdheden voor dit elektricienswerk zoals vastgelegd in de plaatselijke wetten en voorschriften, en hij of zij is opgeleid voor elektricienswerk aan de airconditioners vervaardigd door de Toshiba Carrier Corporation, of anders is hij of zij geïnstrueerd in dergelijke ingrepen door een persoon of personen die daarvoor zijn opgeleid, en beschikt als zodanig over alle vereiste kennis voor deze ingrepen. De bevoegd installateur die kan worden toegestaan de vereiste koelmiddelwerkzaamheden en buizenaanleg te verrichten voor de installatie, het verplaatsen en het wegdoen, beschikt over de bevoegdheden voor buizenaanleg en koelmiddelwerk zoals vastgelegd in de plaatselijke wetten en voorschriften, en hij of zij is opgeleid voor buizenaanleg en koelmiddelwerk aan de airconditioners vervaardigd door de Toshiba Carrier Corporation, of anders is hij of zij geïnstrueerd in dergelijke ingrepen door een persoon of personen die daarvoor zijn opgeleid, en beschikt als zodanig over alle vereiste kennis voor deze ingrepen. De bevoegd installateur die kan worden toegestaan op hoge installatieplaatsen te werken is opgeleid inzake het werken op hoge installatieplaatsen aan de airconditioners vervaardigd door de Toshiba Carrier Corporation, of anders is hij of zij geïnstrueerd in dergelijke ingrepen door een persoon of personen die daarvoor zijn opgeleid, en beschikt als zodanig over alle vereiste kennis voor deze ingrepen.

Bevoegd onderhoudsmonteur	<ul style="list-style-type: none"> Een bevoegd onderhoudsmonteur is een persoon die zorgt voor het installeren, repareren, onderhouden, verplaatsen en wegdoen van de airconditioners vervaardigd door de Toshiba Carrier Corporation. Hij of zij is opgeleid voor het installeren, repareren, onderhouden, verplaatsen en wegdoen van de airconditioners vervaardigd door de Toshiba Carrier Corporation, of anders is hij of zij geïnstrueerd in dergelijke ingrepen door een persoon of personen die daarvoor zijn opgeleid, en beschikt als zodanig over alle vereiste kennis voor deze ingrepen. De bevoegd onderhoudsmonteur die kan worden toegestaan de vereiste elektrische ingrepen te verrichten voor de installatie, reparatie, het verplaatsen en het wegdoen, beschikt over de bevoegdheden voor dit elektricienswerk zoals vastgelegd in de plaatselijke wetten en voorschriften, en hij of zij is opgeleid voor elektricienswerk aan de airconditioners vervaardigd door de Toshiba Carrier Corporation, of anders is hij of zij geïnstrueerd in dergelijke ingrepen door een persoon of personen die daarvoor zijn opgeleid, en beschikt als zodanig over alle vereiste kennis voor deze ingrepen. De bevoegd onderhoudsmonteur die kan worden toegestaan de nodige koelmiddelwerkzaamheden en buizenaanleg te verrichten voor de installatie, reparatie, het verplaatsen en het wegdoen, beschikt over de bevoegdheden voor buizenaanleg en koelmiddelwerk zoals vastgelegd in de plaatselijke wetten en voorschriften, en hij of zij is opgeleid voor buizenaanleg en koelmiddelwerk aan de airconditioners vervaardigd door de Toshiba Carrier Corporation, of anders is hij of zij geïnstrueerd in dergelijke ingrepen door een persoon of personen die daarvoor zijn opgeleid, en beschikt als zodanig over alle vereiste kennis voor deze ingrepen. De bevoegd onderhoudsmonteur die kan worden toegestaan op hoge installatieplaatsen te werken is opgeleid inzake het werken op hoge installatieplaatsen aan de airconditioners vervaardigd door de Toshiba Carrier Corporation, of anders is hij of zij geïnstrueerd in dergelijke ingrepen door een persoon of personen die daarvoor zijn opgeleid, en beschikt als zodanig over alle vereiste kennis voor deze ingrepen.
---------------------------	--

Definitie van beschermende kleding

Voor het vervoer, installeren, onderhoud, repareren en wegdoen van de airconditioner dient u stevige werkhandschoenen en beschermende kleding te dragen.

Naast dergelijke normale veiligheidswerkkleding dient u de hieronder beschreven speciale beschermende kleding te dragen voor de werkzaamheden vermeld in de onderstaande tabel.

Werken aan de apparatuur zonder beschermende kleding te dragen is gevaarlijk, omdat u kwetsbaarder bent voor verwondingen, elektrische schokken, brandwonden en ander letsel.

Te verrichten werkzaamheden	Beschermende kleding
Alle soorten werk	Werkhandschoenen Veiligheidswerkkleding
Elektrische werkzaamheden	Handschoenen die bescherming bieden tegen elektrische schokken Isolerend schoeisel Kleding die bescherming biedt tegen elektrische schokken
Werkzaamheden op hoge plaatsen (50 cm of meer)	Veiligheidshelm voor industrieel gebruik
Vervoer van zware voorwerpen	Schoenen met extra verstevigde neuzen
Reparatie van buiteneenheden	Handschoenen die bescherming bieden tegen elektrische schokken

■ Zwaartepunt

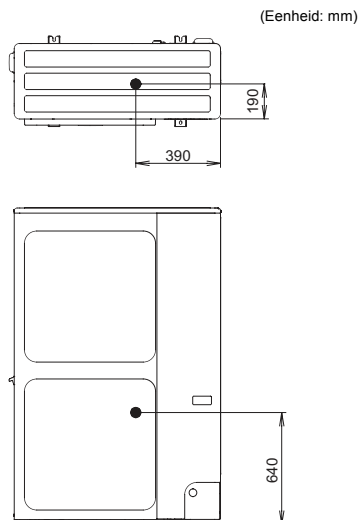

In deze veiligheidsvoorzorgsmaatregelen worden belangrijke punten beschreven met betrekking tot veiligheid om letsel bij gebruikers of andere personen en schade aan eigendommen te voorkomen. Lees deze handleiding door nadat u de onderstaande informatie (betekenissen van aanduidingen) hebt begrepen en houd u altijd aan de beschrijving.

Aanduiding	Betekenis aanduiding
WAARSCHUWING	Tekst die op deze manier wordt aangeduid, geeft aan dat het niet voldoen aan de instructies in de waarschuwing kan leiden tot ernstig lichamelijk letsel (*1) of overlijden als onjuist wordt omgegaan met het product.
VOORZICHTIG	Tekst die op deze manier wordt aangeduid, geeft aan dat het niet voldoen aan de instructies in de waarschuwing kan leiden tot licht lichamelijk letsel (*2) of schade (*3) aan eigendommen als onjuist wordt omgegaan met het product.



*1: Met ernstig lichamelijk letsel worden blindheid, letsel, brandwonden, elektrische schokken, botbreuken, vergiftiging en andere verwondingen met na-effecten bedoeld waarbij ziekenhuisopname of langdurige behandeling als externe patiënt is vereist.

*2: Met licht letsel worden letsel, brandwonden, elektrische schokken en andere verwondingen bedoeld waarbij ziekenhuisopname of langdurige behandeling als externe patiënt niet nodig is.

*3: Met schade aan eigendommen wordt schade aan gebouwen, huisraad, vee en huisdieren bedoeld.

■ **Waarschuingsaanduidingen op de airconditioner**

	WAARSCHUWING (Brandrisico)	Deze markering geldt uitsluitend voor het koelmiddel R32. Het type koelmiddel staat vermeld op de naamplaat van de buiteneenheid. In geval dat het type koelmiddel R32 is, maakt deze eenheid gebruik van een brandbaar koelmiddel. Als er koelmiddel lekt en in aanraking komt met vuur of een verwarmingsonderdeel, creëert dit schadelijk gas en bestaat er een brandrisico.
	Lees de GEBRUIKERSHANDLEIDING zorgvuldig door voorafgaand aan gebruik.	
	Onderhoudspersoneel dient de GEBRUIKERSHANDLEIDING en de INSTALLATIEHANDLEIDING voorafgaand aan gebruik zorgvuldig door te lezen.	
	Meer informatie is beschikbaar in de GEBRUIKERSHANDLEIDING, de INSTALLATIEHANDLEIDING en dergelijke.	

Waarschuingsaanduiding	Beschrijving		
 <table border="1"> <tr> <td>WARNING</td> </tr> <tr> <td>ELECTRICAL SHOCK HAZARD Disconnect all remote electric power supplies before servicing.</td> </tr> </table>	WARNING	ELECTRICAL SHOCK HAZARD Disconnect all remote electric power supplies before servicing.	WAARSCHUWING GEVAAR VOOR ELEKTRISCHE SCHOK Verbreek alle externe stroomvoorzieningsaansluitingen alvorens enig onderhoud te verrichten.
WARNING			
ELECTRICAL SHOCK HAZARD Disconnect all remote electric power supplies before servicing.			
 <table border="1"> <tr> <td>WARNING</td> </tr> <tr> <td>Moving parts. Do not operate unit with grille removed. Stop the unit before the servicing.</td> </tr> </table>	WARNING	Moving parts. Do not operate unit with grille removed. Stop the unit before the servicing.	WAARSCHUWING Bewegende delen. Schakel het apparaat niet in wanneer het voorrooster is verwijderd. Stop de werking van het apparaat alvorens enig onderhoud te verrichten.
WARNING			
Moving parts. Do not operate unit with grille removed. Stop the unit before the servicing.			
 <table border="1"> <tr> <td>CAUTION</td> </tr> <tr> <td>High temperature parts. You might get burned when removing this panel.</td> </tr> </table>	CAUTION	High temperature parts. You might get burned when removing this panel.	VOORZICHTIG Delen met hoge temperaturen. Bij het verwijderen van dit paneel is bestaan de kans dat u zich brandt.
CAUTION			
High temperature parts. You might get burned when removing this panel.			

	CAUTION	VOORZICHTIG Raak de aluminium koelvinnen van het apparaat niet aan. Dat zou tot ernstige verwondingen kunnen leiden.
	Do not touch the aluminum fins of the unit. Doing so may result in injury.	
	CAUTION	VOORZICHTIG GEVAAR VOOR UITBARSTING Open voor enige ingreep eerst de veiligheidskleppen, anders kan er een uitbarsting volgen.
	BURST HAZARD Open the service valves before the operation, otherwise there might be the burst.	

1 VEILIGHEIDSVOORSCHRIFTEN

De fabrikant is niet aansprakelijk voor schade veroorzaakt door het niet opvolgen van de in de handleiding gegeven aanwijzingen.

⚠ WAARSCHUWING

Algemeen

- Alvorens u begint met installeren van de airconditioner, leest u de installatiehandleiding aandachtig door en volgt u alle aanwijzingen daarin voor de installatie van de airconditioner.
- Alleen een bevoegd installateur(*1) of bevoegd onderhoudsmonteur(*1) mag de airconditioner installeren. Als het installeren van de airconditioner wordt verricht door een onbevoegde, kan dat leiden tot gevaar voor brand, elektrische schokken, verwondingen, waterlekkage, bijgeluiden en/of trillingen.
- Gebruik geen ander koelmiddel dan het gespecificeerde middel voor het bijvullen of verversen. De koelcyclus zal anders mogelijk onder extreem hoge druk komen, wat een onjuiste werking, ontploffing van het toestel of lichamelijk letsel zou kunnen veroorzaken.
- Gebruik een vorkheftruck om de airconditioner te verplaatsen, of verplaats de airconditioner met minstens 4 personen wanneer deze met de hand verplaatst moet worden.
- Voordat u het inlaatrooster van de binneneenheid of het onderhoudspaneel van de buiteneenheid opent, zet u eerst de stroomonderbreker in de OFF-stand. Als u verzuimt de stroomonderbreker in de OFF-stand te zetten, loopt u de kans op een elektrische schok bij aanraken van de inwendige onderdelen. Alleen een bevoegd installateur(*1) of een bevoegd onderhoudsmonteur(*1) mag het inlaatrooster van de binneneenheid of het onderhoudspaneel van de buiteneenheid verwijderen en het vereiste werk verrichten.

- Alvorens u begint met installeren, onderhoud, reparaties of werk voor afdanken van het apparaat, zet u eerst de stroomonderbreker in de OFF-stand. Anders loopt u de kans een elektrische schok te krijgen.
- Plaats een bordje "werk in uitvoering" bij de stroomonderbreker tijdens het installeren, onderhoud, reparatiewerk of werk voor afdanken van het apparaat. Als iemand per vergissing de stroomonderbreker in de ON-stand zet, loopt u de kans een elektrische schok te krijgen.
- Alleen een bevoegd installateur(*1) of een bevoegd onderhoudsmonteur(*1) mag werkzaamheden op hoogte verrichten met een trapje van 50 cm of meer.
- Draag tijdens het installeren, onderhoud en afdanken van het apparaat altijd werkhandschoenen en veiligheidskleding.
- Raak de aluminium koelvinnen van de buiteneenheid niet aan. Anders zou u zich er aan kunnen verwonden. Als het nodig is de koelvin aan te raken, trekt u eerst werkhandschoenen en beschermende kleding aan en begint u dan pas met het werk.
- Plaats nooit voorwerpen op de buiteneenheid en klim er niet bovenop. U zou kunnen vallen of de voorwerpen zouden van de buiteneenheid kunnen vallen en letsel veroorzaken.
- Voor het werken op grotere hoogte gebruikt u een ladder die voldoet aan de ISO 14122-norm en volgt u de aanwijzingen in de handleiding van de ladder. Draag tevens een helm voor industrieel gebruik ter bescherming voordat u aan het werk gaat.
- Bij het werken op hoogte dient u een waarschuwingsbord te plaatsen opdat niemand uw werkplek te dicht nadert, voordat u aan het werk gaat. Anders zouden voorbijgangers gewond kunnen raken door vallende onderdelen en andere voorwerpen.
- U dient te zorgen dat de warmtewisselingsventilator wordt vervoerd in een stabiele toestand. Als er delen van het product defect zijn, dient u contact op te nemen met de leverancier.

- Wijzig niets aan de producten. De onderdelen niet uiteen nemen of wijzigen. Dat zou namelijk brand, elektrische schokken of verwondingen kunnen veroorzaken.
- Dit toestel moet worden gebruikt door experts of opgeleide gebruikers in winkels, de lichte industrie of voor commercieel gebruik door leken.

Het koelmiddel

- Dit product bevat gefluoreerde broeikasgassen.
- Laat gassen niet ontluchten naar de atmosfeer.
- Het apparaat moet worden opgeslagen in een ruimte zonder continu werkende ontstekingsbronnen (bijvoorbeeld: open vuur, een werkend gastoestel of een werkend elektrisch verwarmingstoestel).
- Doorboor of verbrand geen onderdelen van het koelmiddelcircuit.
- Gebruik geen andere methoden om het ontdooiproces te versnellen of om te reinigen dan de methoden die door de fabrikant zijn aanbevolen.
- Houd er rekening mee dat koelmiddelen niet altijd een geur hebben.
- Het koelmiddel in de eenheid is brandbaar. Als het koelmiddel in de ruimte lekt en in aanraking komt met vuur uit een brander, een verwarmingstoestel of een kooktoestel, kan dit leiden tot brand of de vorming van een schadelijk gas.
- Draai gestookte verwarmingstoestellen uit, ventileer de ruimte en neem contact op met de leverancier bij wie u de eenheid hebt aangeschaft.
- Gebruik de eenheid pas weer als een onderhoudsmonteur heeft bevestigd dat het gedeelte waaruit het koelmiddel lekte, is gerepareerd.
- Gebruik bij installatie, verplaatsing of onderhoud van de airconditioner alleen het opgegeven koelmiddel (R32) om de koelmiddelleidingen te vullen. Meng het niet met ander koelmiddel en zorg dat er geen lucht in de leidingen achterblijft.
- Leidingen moeten tegen fysieke schade worden beschermd.
- De naleving van de nationale gaswetgeving moet in acht worden genomen.

Keuze van de installatieplaats

- Als u het apparaat installeert in een kleine kamer, dient u maatregelen te treffen om bij lekkage van koelmiddel in elk geval te zorgen dat de kritieke dampspanning in de kamer niet wordt overschreden. Raadpleeg de dealer van wie u de airconditioner hebt gekocht voor nader advies over de maatregelen. Als er zich sterk geconcentreerd koelmiddel ophoopt, kan dat ongelukken door zuurstofgebrek veroorzaken.
- Installeer de airconditioner niet op een plaats waar brandbare gassen vrijkomen, i.v.m. ontploffingsgevaar. Als er brandbaar gas lekt en zich ophoopt rondom de eenheid, kan er brand ontstaan.
- Draag bij het vervoeren van de airconditioner schoenen met extra verstevigde neuzen.
- Bij het vervoeren van de airconditioner mag u die niet optillen aan de banden rond de verpakkingsdoos. Als de banden zouden breken, loopt u de kans op verwondingen.
- Zet geen verbrandingsapparaat op een plaats waar het in de directe luchtstroom van de airconditioner staat, anders kan er onvolledige verbranding plaatsvinden.
- Installeer de airconditioner niet in een slecht geventileerde ruimte die kleiner is dan de minimale vloeroppervlakte (A_{min}).
Dit geldt voor:
 - Binneneenheden
 - Geïnstalleerde buiteneenheden (bijvoorbeeld: serre, garage, machineruimte enzovoort)Raadpleeg "15 BIJLAGE - [2] Minimale vloeroppervlakte: A_{min} (m²)" om de minimale vloeroppervlakte vast te stellen.

Installatie

- Installeer de airconditioner op een plaats die stevig genoeg is om het gewicht van het apparaat te dragen. Als het ophangpunt niet stevig genoeg is, kan het apparaat vallen, hetgeen letsel kan veroorzaken.
- Bij het installeren van de airconditioner volgt u de aanwijzingen in de installatiehandleiding. Als u die aanwijzingen niet opvolgt, kan het apparaat vallen of kantelen of kunnen er bijgeluiden, trillingen, waterlekkage e.d. optreden.
- Gebruik bij het installeren de bouten (M10) en moeren (M10) die bestemd zijn voor het vastzetten van de buiteneenheid.
- Installeer de buiteneenheid zorgvuldig op een plaats die stevig genoeg is om het gewicht van de buiteneenheid te dragen. Wanneer het steunpunt niet sterk genoeg is, kan de buiteneenheid vallen, met kans op persoonlijk letsel.
- Ventileer de ruimte direct indien er tijdens het installeren koelmiddel lekt. Wanneer gasvormig koelmiddel uit het toestel lekt en in contact komt met open vuur, kunnen er giftige gassen ontstaan.
- De installatie van leidingen moet tot een minimum worden beperkt.

Koelmiddelleiding

- Monteer tijdens de installatiewerkzaamheden de koelmiddelleiding nauwkeurig voordat de airconditioner wordt bediend. Als de compressor wordt bediend met de klep open en zonder koelmiddelbuis, zuigt de compressor lucht aan en ontstaat er overdruk in het koelsysteem, hetgeen kan leiden tot verwondingen.
- Draai de flensmoer met een momentsleutel aan op de voorgeschreven manier. Als de flensmoer al te krachtig wordt aangedraaid, kan de moer een tijd later barsten, waardoor koelmiddel kan gaan lekken.

- Volg voor installatie- en verplaatsingswerk de instructies in de installatiehandleiding en gebruik de gereedschappen en leidingonderdelen die specifiek zijn vervaardigd voor gebruik met het koelmiddel R32. Als leidingonderdelen worden gebruikt die niet zijn ontworpen voor het koelmiddel R32 en de eenheid niet correct wordt geïnstalleerd, kunnen de leidingen barsten en schade of letsel veroorzaken. Daarnaast kunnen waterlekkage, elektrische schokken of brand het gevolg zijn.
- Gebruik stikstofgas voor de test op luchtdichtheid.
- De oplaadslang moet zo worden aangesloten dat deze niet slap hangt.

Elektrische bekabeling

- Alleen een bevoegd installateur(*1) of een bevoegd onderhoudsmonteur(*1) mag elektrische werkzaamheden aan de airconditioner verrichten. Onder geen voorwaarde mag dit werk worden verricht door een onbevoegde, aangezien fouten of vergissingen kunnen leiden tot elektrische schokken en/of kortsluiting of lekstroom.
- Het apparaat moet worden geïnstalleerd overeenkomstig de landelijke regelgeving voor elektra en bedrading. Onvoldoende capaciteit van het voedingscircuit of een niet volledige installatie kan een elektrische schok of brand veroorzaken.
- Gebruik bedrading die voldoet aan de specificaties in de installatiehandleiding en de ter plaatse geldende voorschriften en wetten. Het gebruik van bedrading die niet voldoet aan de specificaties kan resulteren in elektrische schokken, kortsluiting en lekstroom, rookontwikkeling en/of brandgevaar.
- Sluit de apparatuur aan op de aarde. (aardaansluitingen) Onvoldoende aarding kan leiden tot een elektrische schok.
- Sluit de aardleidingen niet aan op gasbuizen, waterleidingsbuizen, of bliksemafleiders of aardleidingen voor telefoondraden.

- Na het voltooien van de verplaatsing of het reparatiewerk dient u te controleren of de aardleidingen naar behoren zijn aangesloten.
- Installeer een stroomonderbreker die voldoet aan de specificaties in de installatiehandleiding en de ter plaatse geldende voorschriften en wetten.
- Installeer de stroomonderbreker op een plaats waar die goed toegankelijk is voor de gebruiker.
- Als u de stroomonderbreker buitenshuis aanbrengt, let dan goed op dat het een specifiek voor buitengebruik geschikt type is.
- Onder geen voorwaarde mag het netsnoer worden verlengd. Aansluitproblemen op een plaats waar het netsnoer is verlengd kunnen leiden tot rookontwikkeling en/of brandgevaar.

Testen

- Nadat u de werkzaamheden hebt voltooid dient u voor het inschakelen van de airconditioner eerst te controleren of het deksel van de elektriciteitskast van de binneneenheid en het onderhoudspaneel van de buiteneenheid zijn gesloten, om vervolgens de stroomonderbreker in de ON-stand te zetten. Als u de stroom inschakelt zonder eerst deze punten te controleren, kunt u een elektrische schok krijgen.
- Als u merkt dat er iets mis is met de airconditioner (wanneer u het controle display ziet of een schroeilucht ruikt, vreemde geluiden hoort of wanneer de airconditioner niet koelt of verwarmt, of wanneer er water uit lekt), raakt u dan zelf de airconditioner niet aan maar zet u de stroomonderbreker in de OFF-stand (UIT) en neemt u contact op met een bevoegd onderhoudsmonteur. Neem de nodige maatregelen om te voorkomen dat het apparaat wordt ingeschakeld (schrijf bijvoorbeeld "defect" dichtbij de stroomonderbreker e.d.) totdat de bevoegde onderhoudsmonteur arriveert. Als de airconditioner in gebruik blijft terwijl er iets mis mee is, kan dat leiden tot ernstige mechanische problemen en gevaar voor een elektrische schok e.d.

- Nadat het werk is voltooid, dient u altijd met een isolatietester (500 VMΩ) te controleren of de weerstand 1 MΩ of meer bedraagt tussen het ladingsdragende deel en de niet-geladen metalen delen (aardingsdeel). Als de weerstandswaarde te gering is, kan er kortsluiting, lekstroom of een elektrische schok optreden aan de gebruikerskant.
- Na voltooiing van het installatiewerk controleert u of er geen koelmiddel lekt, of de waterafvoer in orde is en controleert u de weerstand van de isolatie. Vervolgens laat u de airconditioner proefdraaien, om te zien of het apparaat goed werkt.
- Controleer na het installeren dat er geen koelmiddel lekt. Wanneer ontsnapt gasvormig koelmiddel in de buurt of in contact komt met open vuur, zoals bij een gasfornuis, kunnen giftige gassen worden gevormd.

Uitleg aan de gebruiker

- Na voltooiing van het installatiewerk vertelt u de gebruiker waar de stroomonderbreker zich bevindt. Als de gebruiker niet weet waar de stroomonderbreker zit, kan hij of zij de airconditioner niet uitschakelen wanneer er zich een storing voordoet in de werking.
- Als u bemerkt dat het ventilatierooster is beschadigd, moet u uit de buurt blijven van de buitenunit, de stroomonderbreker op de OFF-stand zetten en moet u contact opnemen met bevoegd onderhoudspersoneel(*1) om de reparatie uit te voeren. Zet de stroomonderbreker niet terug in de ON-stand totdat alle vereiste reparaties zijn voltooid.
- Na voltooiing van het installatiewerk vertelt u aan de hand van de eigenaarshandleiding de gebruiker hoe het apparaat te bedienen en te onderhouden.

Elders opstellen

- Alleen een bevoegd installateur(*1) of een bevoegd onderhoudsmonteur(*1) mag de airconditioner verplaatsen. Het is gevaarlijk als een onbevoegde de airconditioner verplaatst, aangezien dat kan leiden tot gevaar voor brand, elektrische schokken, verwondingen, waterlekage, bijgeluiden en/of trillingen.
- Bij uitvoeren van werkzaamheden wanneer de pomp gestopt is, schakelt u eerst de compressor uit voordat u de koelmiddelbuis losmaakt. Bij losmaken van de koelmiddelbuis terwijl de onderhoudsklep open staat en de compressor nog werkt, zuigt de compressor lucht aan en ontstaat er overdruk in het koelsysteem, hetgeen eventueel kan leiden tot verwondingen, enz.

(*1) Zie de "Definitie van een bevoegd installateur of bevoegd onderhoudsmonteur".

⚠ VOORZICHTIG

Deze airconditioner gebruikt het koelmiddel HFC (R32) om aantasting van de ozonlaag te voorkomen

- Koelmiddel R32 heeft een hoge bedrijfsdruk en is vatbaar voor onzuiverheden zoals water, oxiderend membraan en olie. Daarom dient u tijdens installatiewerk extra goed op te letten dat er geen water, stof, eerder koelmiddel, koelmachineolie of andere stoffen in het R32-koelcircuit terechtkomen.
- Speciale gereedschappen voor koelmiddel R32 of R410A zijn vereist voor installatie.
- Gebruik voor verbindingsleidingen nieuwe en schone leidingmaterialen en zorg ervoor dat er geen water en/of stof binnendringt.

Waarschuwingen voor installatieruimte buiteneenheid

- In het geval dat de buiteneenheid in een kleine ruimte wordt geplaatst en er koelvloeistof lekt, kan de ophoping van sterk geconcentreerd koelmiddel een brandrisico veroorzaken. Volg daarom altijd de instructies met betrekking tot de installatieruimte in de installatiehandleiding en zorg voor open ruimte aan ten minste een van de vier zijden van de buiteneenheid.
- Vooral wanneer zowel de uitlaat- als inlaatzijde op een muur zijn gericht en er ook obstakels aan beide zijden van de buiteneenheid zijn geplaatst, dient u stappen te zetten om een ruimte te bieden die breed genoeg is dat één persoon kan passeren (600 mm of meer) aan één zijde om te voorkomen dat gelekt koelmiddel zich ophoopt.

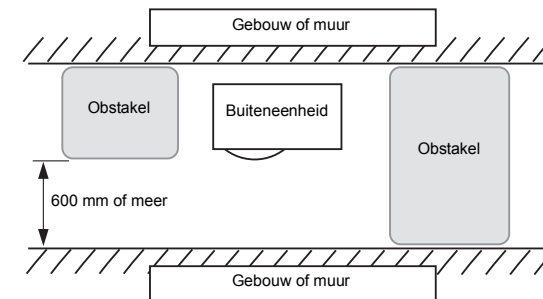

Loskoppelen van de hoofdstroomvoorziening

- Dit systeem moet met de hoofdstroomtoevoer worden verbonden met gebruik van een circuitonderbreker of schakelaar met contactscheiding van ten minste 3 mm.

Airconditioners nooit schoon spuiten met een hogedrukstraal.

- Lekstroom of kortsluiting kan brand of elektrische schokken veroorzaken.

Ευχαριστούμε για την αγορά αυτού του κλιματιστικού Toshiba.

Διαβάστε προσεκτικά αυτές τις οδηγίες, συμπεριλαμβανομένων των σημαντικών πληροφοριών που συμμορφώνονται με την «Οδηγία σχετικά με μηχανήματα» (Οδηγία 2006/42/ΕΚ), και βεβαιωθείτε ότι τις καταλαβαίνετε.

Όταν διαβάσετε αυτές τις οδηγίες, φροντίστε να τις φυλάξετε σε ασφαλές μέρος μαζί με το Εγχειρίδιο Κατόχου και το Εγχειρίδιο Εγκατάστασης τα οποία παρέχονται με το προϊόν σας.

Γενικός χαρακτηρισμός: Κλιματιστική μονάδα

Ορισμός Εξειδικευμένου Εγκαταστάτη ή Εξειδικευμένου Τεχνικού Σέρβις

Απαιτείται εγκατάσταση, συντήρηση, επισκευή και απόρριψη του κλιματιστικού από εξειδικευμένο εγκαταστάτη ή εξειδικευμένο τεχνικό σέρβις. Όταν απαιτείται εκτέλεση οποιασδήποτε από τις συγκεκριμένες εργασίες, αναθέστε την εκτέλεσή της σε εξειδικευμένο εγκαταστάτη ή εξειδικευμένο τεχνικό σέρβις.

Ένας εξειδικευμένος εγκαταστάτης ή εξειδικευμένος τεχνικός σέρβις είναι αντιπρόσωπος ο οποίος διαθέτει τα προσόντα και τις γνώσεις που περιγράφονται στον πίνακα κατωτέρω.

Αντιπρόσωπος	Προσόντα και γνώσεις τα οποία απαιτείται να διαθέτει ο αντιπρόσωπος
Εξειδικευμένος εγκαταστάτης	<ul style="list-style-type: none"> Ο εξειδικευμένος εγκαταστάτης είναι άτομο το οποίο είναι επιφορτισμένο με την εγκατάσταση, συντήρηση, αλλαγή θέσης και απόρριψη των κλιματιστικών παραγωγής της Toshiba Carrier Corporation. Έχει εκπαιδευτεί στην εγκατάσταση, συντήρηση, αλλαγή θέσης και απόρριψη των κλιματιστικών παραγωγής της Toshiba Carrier Corporation ή, εναλλακτικά, έχει λάβει οδηγίες σχετικά με την εκτέλεση των εν λόγω εργασιών από άτομο ή άτομα τα οποία έχουν εκπαιδευτεί, και επομένως έχει εξοικειωθεί απολύτως με τις γνώσεις που απαιτούνται για τις εν λόγω εργασίες. Ο εξειδικευμένος εγκαταστάτης ο οποίος επιτρέπεται να αναλαμβάνει την εκτέλεση των ηλεκτρολογικών εργασιών που απαιτούνται για την εγκατάσταση, αλλαγή θέσης και απόρριψη διαθέτει τα προσόντα για την εκτέλεση των εν λόγω ηλεκτρολογικών εργασιών όπως ορίζεται από τους τοπικούς νόμους και κανονισμούς, και είναι άτομο το οποίο έχει εκπαιδευτεί σε θέματα τα οποία σχετίζονται με την εκτέλεση ηλεκτρολογικών εργασιών στα κλιματιστικά παραγωγής της Toshiba Carrier Corporation ή, εναλλακτικά, έχει λάβει οδηγίες πάνω στα εν λόγω θέματα από άτομο ή άτομα τα οποία έχουν εκπαιδευτεί, και επομένως έχει εξοικειωθεί απολύτως με τις γνώσεις που απαιτούνται για τις εν λόγω εργασίες. Ο εξειδικευμένος εγκαταστάτης ο οποίος επιτρέπεται να αναλαμβάνει την εκτέλεση των εργασιών που αφορούν το χειρισμό του ψυκτικού υγρού και τη διαμόρφωση των σωληνώσεων και απαιτούνται για την εγκατάσταση, αλλαγή θέσης και απόρριψη διαθέτει τα προσόντα για την εκτέλεση των εν λόγω εργασιών, που αφορούν το χειρισμό του ψυκτικού υγρού και τη διαμόρφωση των σωληνώσεων, όπως ορίζεται από τους τοπικούς νόμους και κανονισμούς, και είναι άτομο το οποίο έχει εκπαιδευτεί σε θέματα τα οποία σχετίζονται με την εκτέλεση εργασιών που αφορούν το χειρισμό του ψυκτικού υγρού και τη διαμόρφωση των σωληνώσεων στα κλιματιστικά παραγωγής της Toshiba Carrier Corporation ή, εναλλακτικά, έχει λάβει οδηγίες πάνω στα εν λόγω θέματα από άτομο ή άτομα τα οποία έχουν εκπαιδευτεί, και επομένως έχει εξοικειωθεί απολύτως με τις γνώσεις που απαιτούνται για τις εν λόγω εργασίες. Ο εξειδικευμένος εγκαταστάτης ο οποίος επιτρέπεται να αναλαμβάνει την εκτέλεση εργασιών σε υψηλά σημεία έχει εκπαιδευτεί σε θέματα τα οποία σχετίζονται με τις εργασίες σε υψηλά σημεία πάνω στα κλιματιστικά παραγωγής της Toshiba Carrier Corporation ή, εναλλακτικά, έχει λάβει οδηγίες πάνω στα εν λόγω θέματα από άτομο ή άτομα τα οποία έχουν εκπαιδευτεί, και επομένως έχει εξοικειωθεί απολύτως με τις γνώσεις που απαιτούνται για τις εν λόγω εργασίες.

Εξειδικευμένος τεχνικός σέρβις	<ul style="list-style-type: none"> Ο εξειδικευμένος τεχνικός σέρβις είναι άτομο το οποίο είναι επιφορτισμένο με την εγκατάσταση, επισκευή, συντήρηση, αλλαγή θέσης και απόρριψη κλιματιστικών συσκευών παραγωγής της Toshiba Carrier Corporation. Έχει εκπαιδευτεί στην εγκατάσταση, επισκευή, συντήρηση, αλλαγή θέσης και απόρριψη των κλιματιστικών παραγωγής της Toshiba Carrier Corporation ή, εναλλακτικά, έχει λάβει οδηγίες σχετικά με την εκτέλεση των εν λόγω εργασιών από άτομο ή άτομα τα οποία έχουν εκπαιδευτεί, και επομένως έχει εξοικειωθεί απολύτως με τις γνώσεις που απαιτούνται για τις εν λόγω εργασίες. Ο εξειδικευμένος τεχνικός σέρβις ο οποίος επιτρέπεται να αναλαμβάνει την εκτέλεση των ηλεκτρολογικών εργασιών που απαιτούνται για την εγκατάσταση, επισκευή, αλλαγή θέσης και απόρριψη διαθέτει τα προσόντα για την εκτέλεση των εν λόγω ηλεκτρολογικών εργασιών όπως ορίζεται από τους τοπικούς νόμους και κανονισμούς, και είναι άτομο το οποίο έχει εκπαιδευτεί σε θέματα τα οποία σχετίζονται με την εκτέλεση ηλεκτρολογικών εργασιών στα κλιματιστικά παραγωγής της Toshiba Carrier Corporation ή, εναλλακτικά, έχει λάβει οδηγίες πάνω στα εν λόγω θέματα από άτομο ή άτομα τα οποία έχουν εκπαιδευτεί, και επομένως έχει εξοικειωθεί απολύτως με τις γνώσεις που απαιτούνται για τις εν λόγω εργασίες. Ο εξειδικευμένος τεχνικός σέρβις ο οποίος επιτρέπεται να αναλαμβάνει την εκτέλεση των εργασιών που αφορούν το χειρισμό του ψυκτικού υγρού και τη διαμόρφωση των σωληνώσεων και απαιτούνται για την εγκατάσταση, επισκευή, αλλαγή θέσης και απόρριψη διαθέτει τα προσόντα για την εκτέλεση των εν λόγω εργασιών, που αφορούν το χειρισμό του ψυκτικού υγρού και τη διαμόρφωση των σωληνώσεων, όπως ορίζεται από τους τοπικούς νόμους και κανονισμούς, και είναι άτομο το οποίο έχει εκπαιδευτεί σε θέματα τα οποία σχετίζονται με την εκτέλεση εργασιών που αφορούν το χειρισμό του ψυκτικού υγρού και τη διαμόρφωση των σωληνώσεων στα κλιματιστικά παραγωγής της Toshiba Carrier Corporation ή, εναλλακτικά, έχει λάβει οδηγίες πάνω στα εν λόγω θέματα από άτομο ή άτομα τα οποία έχουν εκπαιδευτεί, και επομένως έχει εξοικειωθεί απολύτως με τις γνώσεις που απαιτούνται για τις εν λόγω εργασίες. Ο εξειδικευμένος τεχνικός σέρβις ο οποίος επιτρέπεται να αναλαμβάνει την εκτέλεση εργασιών σε υψηλά σημεία έχει εκπαιδευτεί σε θέματα τα οποία σχετίζονται με τις εργασίες σε υψηλά σημεία πάνω στα κλιματιστικά παραγωγής της Toshiba Carrier Corporation ή, εναλλακτικά, έχει λάβει οδηγίες πάνω στα εν λόγω θέματα από άτομο ή άτομα τα οποία έχουν εκπαιδευτεί, και επομένως έχει εξοικειωθεί απολύτως με τις γνώσεις που απαιτούνται για τις εν λόγω εργασίες.
--------------------------------	--

Ορισμός εξοπλισμού προστασίας

Όταν το κλιματιστικό προορίζεται για μεταφορά, εγκατάσταση, συντήρηση, επισκευή ή απόρριψη, να φοράτε γάντια προστασίας και ρουχισμό για την ασφάλεια κατά την εργασία.

Πέραν του συγκεκριμένου συνήθους εξοπλισμού προστασίας, να φοράτε τον εξοπλισμό προστασίας που περιγράφεται κατωτέρω, όταν αναλαμβάνετε την εκτέλεση των ειδικών εργασιών που αναγράφονται στον πίνακα κατωτέρω.

Η μη χρήση του κατάλληλου εξοπλισμού προστασίας είναι επικίνδυνη, επειδή θα είστε πιο ευάλωτοι σε ενδεχόμενο τραυματισμό, εγκαύματα, ηλεκτροπληξία και άλλους τραυματισμούς.

Εκτελούμενη εργασία	Χρήση εξοπλισμού προστασίας
Κάθε τύπος εργασίας	Γάντια προστασίας Ρουχισμός για την ασφάλεια κατά την εργασία
Ηλεκτρολογικές εργασίες	Γάντια για προστασία από ηλεκτροπληξία Υποδήματα με μόνωση Ρουχισμός προστασίας από ηλεκτροπληξία
Εκτέλεση εργασίας σε υψηλά σημεία (50 cm ή περισσότερο)	Κράνη βιομηχανικής χρήσης
Μεταφορά βαρέων αντικειμένων	Υποδήματα με επιπρόσθετη προστατευτική μύτη
Επισκευή εξωτερικής μονάδας	Γάντια για προστασία από ηλεκτροπληξία

■ Κέντρο βαρύτητας

(Μονάδα: mm)

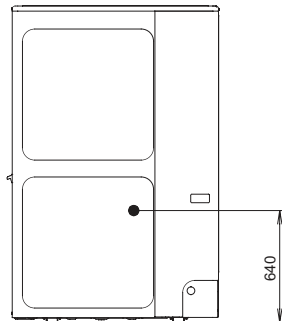
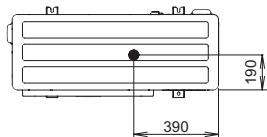

Αυτές οι επισημάνσεις προσοχής για την ασφάλεια περιγράφουν σημαντικά ζητήματα που αφορούν την ασφάλεια, για την αποφυγή τραυματισμών σε χρήστες ή άλλα άτομα και ζημιών σε ιδιοκτησία. Διαβάστε το παρόν εγχειρίδιο αφού κατανοήσετε το παρακάτω περιεχόμενο (επεξήγηση ενδείξεων) και βεβαιωθείτε να ακολουθήσετε την περιγραφή.





Ένδειξη	Επεξήγηση ενδείξεων
ΠΡΟΕΙΔΟΠΟΙΗΣΗ	Το κείμενο που φέρει αυτή την ένδειξη υποδεικνύει ότι η μη συμμόρφωση με τις οδηγίες στην προειδοποίηση μπορεί να προκαλέσει σοβαρό τραυματισμό (*1) ή θάνατο, αν δεν γίνει σωστός χειρισμός του προϊόντος.
ΠΡΟΣΟΧΗ	Το κείμενο που φέρει αυτή την ένδειξη υποδεικνύει ότι η μη συμμόρφωση με τις οδηγίες στην επισήμανση προσοχής μπορεί να προκαλέσει ελαφρύ τραυματισμό (*2) ή ζημιά (*3) σε ιδιοκτησία, αν δεν γίνει σωστός χειρισμός του προϊόντος.



*1: Ο όρος "σοβαρός τραυματισμός" αναφέρεται σε τύφλωση, τραυματισμό, εγκαύματα, ηλεκτροπληξία, κατάγματα οστών, δηλητηρίαση και άλλους τραυματισμούς, οι οποίοι αφήνουν υπολειμματικές επιπτώσεις και απαιτούν περίθαλψη σε νοσοκομείο ή παρατεταμένη θεραπεία ως εξωτερικός ασθενής.



*2: Ο όρος "ελαφρύς τραυματισμός" αναφέρεται σε τραυματισμό, έγκαυμα, ηλεκτροπληξία και άλλους τραυματισμούς, οι οποίοι δεν απαιτούν περίθαλψη σε νοσοκομείο ή παρατεταμένη θεραπεία ως εξωτερικός ασθενής.

*3: Ο όρος "ζημιά σε ιδιοκτησία" αναφέρεται σε ζημιά που εκτείνεται σε κτίρια, οικιακά είδη, οικόσιτα ζώα και κατοικίδια ζώα.

■ Προειδοποιητικές ενδείξεις πάνω στην κλιματιστική μονάδα

	ΠΡΟΕΙΔΟΠΟΙΗΣΗ (Κίνδυνος πυρκαγιάς)	Αυτό το σήμα αφορά μόνο ψυκτικό R32. Ο τύπος ψυκτικού αναγράφεται στην πινακίδα ονομαστικών τιμών της εξωτερικής μονάδας. Στην περίπτωση που ο τύπος ψυκτικού είναι R32, αυτή η μονάδα χρησιμοποιεί εύφλεκτο ψυκτικό. Αν το ψυκτικό διαρρεύσει και έρθει σε επαφή με φωτιά ή θερμαντικό μέρος, θα δημιουργήσει ένα βλαβερό αέριο και θα υπάρξει κίνδυνος πυρκαγιάς.
	Διαβάστε προσεκτικά το ΕΓΧΕΙΡΙΔΙΟ ΚΑΤΟΧΟΥ πριν τη λειτουργία.	
	Το προσωπικό σέρβις πρέπει να διαβάσει προσεκτικά το ΕΓΧΕΙΡΙΔΙΟ ΚΑΤΟΧΟΥ και το ΕΓΧΕΙΡΙΔΙΟ ΕΓΚΑΤΑΣΤΑΣΗΣ πριν τη λειτουργία.	
	Διατίθενται περαιτέρω πληροφορίες στο ΕΓΧΕΙΡΙΔΙΟ ΚΑΤΟΧΟΥ, στο ΕΓΧΕΙΡΙΔΙΟ ΕΓΚΑΤΑΣΤΑΣΗΣ και άλλα.	

Προειδοποιητική ένδειξη	Περιγραφή		
 <table border="1"> <tr> <td>WARNING</td> </tr> <tr> <td>ELECTRICAL SHOCK HAZARD Disconnect all remote electric power supplies before servicing.</td> </tr> </table>	WARNING	ELECTRICAL SHOCK HAZARD Disconnect all remote electric power supplies before servicing.	ΠΡΟΕΙΔΟΠΟΙΗΣΗ ΚΙΝΔΥΝΟΣ ΗΛΕΚΤΡΟΠΛΗΞΙΑΣ Αποσυνδέστε όλες τις απομακρυσμένες παροχές ηλεκτρικής τροφοδοσίας πριν από τη διενέργεια σέρβις.
WARNING			
ELECTRICAL SHOCK HAZARD Disconnect all remote electric power supplies before servicing.			
 <table border="1"> <tr> <td>WARNING</td> </tr> <tr> <td>Moving parts. Do not operate unit with grille removed. Stop the unit before the servicing.</td> </tr> </table>	WARNING	Moving parts. Do not operate unit with grille removed. Stop the unit before the servicing.	ΠΡΟΕΙΔΟΠΟΙΗΣΗ Κινούμενα μέρη. Μην θέσετε τη μονάδα σε λειτουργία, εάν έχετε αφαιρέσει τη γρίλια. Διακόψτε τη λειτουργία της μονάδας πριν από τη διενέργεια σέρβις.
WARNING			
Moving parts. Do not operate unit with grille removed. Stop the unit before the servicing.			
 <table border="1"> <tr> <td>CAUTION</td> </tr> <tr> <td>High temperature parts. You might get burned when removing this panel.</td> </tr> </table>	CAUTION	High temperature parts. You might get burned when removing this panel.	ΠΡΟΣΟΧΗ Μέρη με υψηλή θερμοκρασία. Ενδέχεται να υποστείτε έγκαυμα κατά την αφαίρεση αυτού του πινάκα.
CAUTION			
High temperature parts. You might get burned when removing this panel.			

	CAUTION	ΠΡΟΣΟΧΗ Μην αγγίζετε τα πτερύγια αλουμινίου της μονάδας. Η μη συμμόρφωση ενδέχεται να προκαλέσει τραυματισμό.
	Do not touch the aluminum fins of the unit. Doing so may result in injury.	
	CAUTION	ΠΡΟΣΟΧΗ ΚΙΝΔΥΝΟΣ ΕΚΡΗΞΗΣ Ανοίξτε τις βαλβίδες σέρβις πριν από τη λειτουργία, διαφορετικά ενδέχεται να προκληθεί έκρηξη.
	BURST HAZARD Open the service valves before the operation, otherwise there might be the burst.	

1 ΠΡΟΦΥΛΑΞΕΙΣ ΑΣΦΑΛΕΙΑΣ

Ο κατασκευαστής αποποιείται κάθε ευθύνη για ζημιές που τυχόν προκύψουν λόγω της μη τήρησης των οδηγιών του παρόντος εγχειριδίου.

⚠ ΠΡΟΕΙΔΟΠΟΙΗΣΗ

Γενικά

- Πριν ξεκινήσετε με την εγκατάσταση του κλιματιστικού, διαβάστε με προσοχή το Εγχειρίδιο Εγκατάστασης και ακολουθήστε τις οδηγίες του για την εγκατάσταση του κλιματιστικού.
- Η εγκατάσταση του κλιματιστικού επιτρέπεται μόνον από εξειδικευμένο εγκαταστάτη(*1) ή εξειδικευμένο τεχνικό σέρβις(*1). Σε περίπτωση εγκατάστασης του κλιματιστικού από ανειδίκευτο άτομο, ενδέχεται να προκληθεί πυρκαγιά, ηλεκτροπληξία, τραυματισμός, διαρροή νερού, θόρυβος ή και κραδασμοί.
- Να χρησιμοποιείτε αποκλειστικά και μόνο το καθορισμένο ψυκτικό για συμπλήρωση ή αντικατάσταση. Σε διαφορετική περίπτωση, ενδέχεται να προκληθεί αφύσικα υψηλή πίεση στον κύκλο ψύξης, η οποία μπορεί να οδηγήσει σε αστοχία ή έκρηξη του προϊόντος ή στον σωματικό τραυματισμό του χρήστη.
- Για την μεταφορά του κλιματιστικού χρησιμοποιήστε περονοφόρο όχημα και εάν μεταφέρετε την μονάδα με τα χέρια μετακινήστε την με την βοήθεια 4 ατόμων.
- Πριν ανοίξετε τη γρίλια εισαγωγής της εσωτερικής μονάδας ή του πίνακα σέρβις της εξωτερικής μονάδας, θέστε τον αυτόματο διακόπτη κυκλώματος στη θέση OFF. Εάν δεν θέσετε τον αυτόματο διακόπτη κυκλώματος στη θέση OFF ενδέχεται να προκληθεί ηλεκτροπληξία λόγω τυχαίας επαφής με τα εξαρτήματα στο εσωτερικό της μονάδας. Η αφαίρεση της γρίλιας εισαγωγής της εσωτερικής μονάδας ή του πίνακα σέρβις της εξωτερικής μονάδας και η εκτέλεση των απαιτούμενων εργασιών, επιτρέπεται μόνον από εξειδικευμένο εγκαταστάτη(*1) ή εξειδικευμένο τεχνικό σέρβις(*1).

- Πριν από την εκτέλεση εργασιών εγκατάστασης, συντήρησης, επισκευής ή απόρριψης, φροντίστε να θέσετε τον αυτόματο διακόπτη κυκλώματος στη θέση OFF. Διαφορετικά, ενδέχεται να προκληθεί ηλεκτροπληξία.
- Αναρτήστε πινακίδα με την ένδειξη "Εκτελούνται εργασίες" κοντά στον αυτόματο διακόπτη κυκλώματος ενόσω εκτελούνται εργασίες εγκατάστασης, συντήρησης, επισκευής ή απόρριψης. Υπάρχει κίνδυνος πρόκλησης ηλεκτροπληξίας, εάν ο αυτόματος διακόπτης κυκλώματος τεθεί στη θέση ON τυχαία.
- Η εκτέλεση των εργασιών σε υψηλό σημείο με χρήση σταντ ύψους 50 cm ή μεγαλύτερου, επιτρέπεται να πραγματοποιηθεί μόνο από εξειδικευμένο τεχνικό εγκατάστασης(*1) ή εξειδικευμένο τεχνικό σέρβις(*1).
- Να φοράτε γάντια προστασίας και ρουχισμό για την ασφάλεια κατά την εργασία, όταν εκτελείτε εργασίες εγκατάστασης, σέρβις και απόρριψης.
- Μην αγγίζετε το πτερύγιο αλουμινίου της εξωτερικής μονάδας. Ενδέχεται να τραυματιστείτε εάν το πράξετε. Εάν απαιτείται να αγγίξετε το πτερύγιο για οποιοδήποτε λόγο, φορέστε πρώτα γάντια προστασίας και ρουχισμό για την ασφάλεια κατά την εργασία και τότε μόνον προχωρήστε.
- Μην ανεβαίνετε πάνω στην εξωτερική μονάδα και μην τοποθετείτε αντικείμενα πάνω σε αυτήν. Μπορεί να πέσετε ή να πέσουν κάτω τα αντικείμενα που βρίσκονται πάνω στην εξωτερική μονάδα και να προκληθεί τραυματισμός.
- Όταν εργάζεστε σε υψηλά σημεία, να χρησιμοποιείτε σκάλα η οποία συμμορφώνεται με το πρότυπο ISO 14122 και να ακολουθείτε τη διαδικασία που αναγράφεται στις οδηγίες της σκάλας. Να φοράτε επίσης, κράνος βιομηχανικής χρήσης ως εξοπλισμό προστασίας πριν από την εκτέλεση της εργασίας.
- Όταν εργάζεστε σε υψηλά σημεία, αναρτήστε προειδοποιητική πινακίδα σε κατάλληλο σημείο ώστε να μην πλησιάζει κανείς στο χώρο των εργασιών, πριν προχωρήσετε στην εκτέλεση των εργασιών. Εξαρτήματα και άλλα αντικείμενα ενδέχεται να υποστούν πτώση, τραυματίζοντας ενδεχομένως κάποιο άτομο το οποίο βρίσκεται από κάτω.
- Φροντίστε για τη μεταφορά του κλιματιστικού σε σταθεροποιημένη κατάσταση. Αν οποιοδήποτε μέρος του προϊόντος είναι σπασμένο, επικοινωνήστε με τον αντιπρόσωπο.

- Μην τροποποιείτε τα προϊόντα. Μην αποσυναρμολογήσετε ή τροποποιήσετε τα μέρη. Μπορεί να προκληθεί πυρκαγιά, ηλεκτροπληξία ή τραυματισμός.
- Η συγκεκριμένη συσκευή προορίζεται για χρήση από έμπειρους ή καταρτισμένους χρήστες στον κλάδο της ελαφράς βιομηχανίας ή για εμπορική χρήση από μη ειδικούς.

Πληροφορίες για το ψυκτικό

- Αυτό το προϊόν περιέχει φθοριούχα αέρια του θερμοκηπίου.
- Μην απελευθερώνετε τα αέρια στην ατμόσφαιρα.
- Η συσκευή θα πρέπει να αποθηκευτεί σε ένα δωμάτιο χωρίς πηγές ανάφλεξης που λειτουργούν συνεχόμενα (για παράδειγμα: γυμνές φλόγες, συσκευή αερίου σε λειτουργία ή ηλεκτρικό θερμαντήρα σε λειτουργία).
- Μην διατρυπάτε ή καίγετε τα εξαρτήματα του κύκλου ψυκτικού.
- Μην χρησιμοποιείτε μέσα για να επιταχύνετε τη διαδικασία απόψυξης ή για να καθαρίσετε, διαφορετικά από αυτά που συνιστά ο κατασκευαστής.
- Να γνωρίζετε ότι τα ψυκτικά μπορεί να μην διαθέτουν οσμή.
- Το ψυκτικό στο εσωτερικό της μονάδας είναι εύφλεκτο. Αν το ψυκτικό διαρρέυσει στο δωμάτιο και έρθει σε επαφή με φωτιά από καυστήρα, θερμαντήρα ή φούρνο, μπορεί να έχει ως αποτέλεσμα πυρκαγιά ή το σχηματισμό βλαβερού αερίου.
- Απενεργοποιήστε τυχόν θερμαντικές συσκευές με καύσιμο, αερίστε το δωμάτιο και επικοινωνήστε με τον αντιπρόσωπο από τον οποίο προμηθευτήκατε τη μονάδα.
- Μην χρησιμοποιήσετε τη μονάδα μέχρι κάποιος υπεύθυνος σέρβις να επιβεβαιώσει ότι το τμήμα από το οποίο διαρρέει το ψυκτικό έχει επισκευαστεί.
- Όταν εγκαθιστάτε, αλλάζετε τοποθεσία ή επισκευάζετε το κλιματιστικό, να χρησιμοποιείτε μόνο το συγκεκριμένο ψυκτικό (R32) για την πλήρωση των γραμμών ψυκτικού. Μην το αναμιγνύεται με κανένα άλλο ψυκτικό και μην αφήσετε να παραμείνει αέρας στις γραμμές.
- Οι σωληνώσεις πρέπει να προστατεύονται από φυσική ζημιά.
- Πρέπει να τηρείται η συμμόρφωση με τους εθνικούς κανονισμούς για τα αέρια.

Επιλογή θέσης εγκατάστασης

- Σε περίπτωση εγκατάστασης της μονάδας σε μικρό δωμάτιο, φροντίστε για τη λήψη κατάλληλων μέτρων, ώστε το ψυκτικό υγρό να μην υπερβεί το όριο συγκέντρωσης ακόμη και σε περίπτωση διαρροής. Κατά την εφαρμογή των μέτρων, συμβουλευτείτε τον αντιπρόσωπο από τον οποίο αγοράσατε το κλιματιστικό. Η συσσώρευση υψηλής συγκέντρωσης ψυκτικού υγρού ενδέχεται να προκαλέσει ατύχημα λόγω έλλειψης οξυγόνου.
- Μην εγκαταστήσετε το κλιματιστικό σε θέση, όπου υπάρχει κίνδυνος έκθεσης σε εύφλεκτο αέριο. Αν ένα εύφλεκτο αέριο διαρρεύσει και παραμείνει στο χώρο γύρω από τη μονάδα, ενδέχεται να προκληθεί πυρκαγιά.
- Όταν μεταφέρετε το κλιματιστικό, να φοράτε υποδήματα με επιπρόσθετη προστατευτική μύτη.
- Κατά τη μεταφορά του κλιματιστικού, μην επιχειρήσετε να το συγκρατήσετε από τις ταινίες πρόσδεσης γύρω από το χαρτοκιβώτιο συσκευασίας. Ενδέχεται να τραυματιστείτε, εάν οι ταινίες σπάσουν.
- Μην τοποθετείτε συσκευή καύσης σε σημείο το οποίο εκτίθεται απευθείας στη ροή αέρα του κλιματιστικού, ενδέχεται να προκληθεί ατελής καύση.
- Μην εγκαθιστάτε το κλιματιστικό σε ένα χώρο με ανεπαρκή εξαερισμό, ο οποίος έχει εμβαδόν μικρότερο από το ελάχιστο εμβαδόν δαπέδου (Amin).
Αυτό ισχύει για:
 - Εσωτερικές μονάδες
 - Εγκατεστημένες εξωτερικές μονάδες (για παράδειγμα, χειμερινοί κήποι, γκαράζ, δωμάτιο με μηχανήματα, κτλ.)
 Ανατρέξτε στο "15 ΠΑΡΑΡΤΗΜΑ - [2] Ελάχιστο εμβαδόν δαπέδου: Amin (m²)" για να καθορίσετε το ελάχιστο εμβαδόν δαπέδου.

Εγκατάσταση

- Η εγκατάσταση του κλιματιστικού θα πρέπει να διενεργείται σε σημεία τα οποία είναι ικανά να συγκρατήσουν το βάρος της μονάδας. Εάν τα σημεία αυτά δεν διαθέτουν επαρκή αντοχή, η μονάδα ενδέχεται να υποστεί πτώση και να προκαλέσει τραυματισμό.
- Ακολουθήστε τις οδηγίες που αναγράφονται στο Εγχειρίδιο Εγκατάστασης για να εγκαταστήσετε το κλιματιστικό. Η μη τήρηση αυτών των οδηγιών ενδέχεται να προκαλέσει πτώση ή αναποδογύρισμα του προϊόντος ή δημιουργία θορύβου, κραδασμών, διαρροής νερού, κ.λ.π.
- Κατά την εγκατάσταση της μονάδας, απαιτείται η χρήση των κοχλίων (M10) και των περικοχλίων (M10) αποκλειστικής χρήσης για την ασφάλιση της εξωτερικής μονάδας.
- Εγκαταστήστε την εξωτερική μονάδα σε κατάλληλη θέση, η οποία είναι αρκετά ανθεκτική για να αντέξει το βάρος της εξωτερικής μονάδας. Η ανεπαρκής αντοχή ενδέχεται να προκαλέσει πτώση της μονάδας και, κατά συνέπεια, τραυματισμό.
- Σε περίπτωση διαρροής του ψυκτικού αερίου κατά τη διάρκεια των εργασιών εγκατάστασης, αερίστε τον χώρο αμέσως. Αν η διαρροή του ψυκτικού αερίου έλθει σε επαφή με φλόγα, ενδέχεται να εκλυθούν δηλητηριώδη αέρια.
- Η εγκατάσταση των σωληνώσεων θα πρέπει να διατηρείτε στο ελάχιστο.

Σωληνώσεις ψυκτικού

- Εγκαταστήστε το σωλήνα ψυκτικού με ασφάλεια στη διάρκεια της εργασίας εγκατάστασης πριν θέσετε σε λειτουργία το κλιματιστικό. Εάν ο συμπιεστής λειτουργήσει με τη βαλβίδα ανοιχτή και χωρίς σωλήνα ψυκτικού υγρού, ο συμπιεστής αναρροφά αέρα και ο κύκλος ψύξης υπερσυμπιέζεται, πράγμα το οποίο ενδέχεται να προκαλέσει τραυματισμό.
- Σφίξτε το ρακόρ με ένα ροπόκλειδο ακολουθώντας τον καθορισμένο τρόπο. Τυχόν υπερβολικό σφίξιμο του ρακόρ ενδέχεται να προκαλέσει ράγισμα του ρακόρ μετά από μακρό χρονικό διάστημα, πράγμα το οποίο ενδέχεται να καταλήξει σε διαρροή ψυκτικού υγρού.

- Για εργασίες εγκατάστασης και αλλαγής θέσης, ακολουθήστε τις οδηγίες στο Εγχειρίδιο εγκατάστασης και χρησιμοποιήστε εργαλεία και εξαρτήματα σωλήνων που έχουν κατασκευαστεί ειδικά για χρήση με το ψυκτικό R32. Αν χρησιμοποιηθούν εξαρτήματα σωλήνων που δεν έχουν σχεδιαστεί για ψυκτικό R32 και η μονάδα δεν έχει εγκατασταθεί σωστά, οι σωλήνες μπορεί να σπάσουν και να προκληθεί ζημιά ή τραυματισμοί. Επιπλέον, μπορεί να προκύψει διαρροή νερού, ηλεκτροπληξία ή πυρκαγιά.
- Απαιτείται η χρήση αερίου αζώτου για τη δοκιμή στεγανότητας.
- Ο σωλήνας πλήρωσης πρέπει να συνδεθεί με τρόπο ώστε να μην παρουσιάζει χαλαρότητα.

Ηλεκτρική καλωδίωση

- Η εκτέλεση των ηλεκτρολογικών εργασιών στο κλιματιστικό επιτρέπεται μόνον από εξειδικευμένο εγκαταστάτη(*1) ή εξειδικευμένο τεχνικό σέρβις(*1). Σε καμία περίπτωση δεν επιτρέπεται η εκτέλεση των εν λόγω εργασιών από ανειδίκευτο άτομο, επειδή τυχόν μη κατάλληλη εκτέλεση των εργασιών ενδέχεται να καταλήξει σε ηλεκτροπληξία ή/και διαρροές ρεύματος.
- Η συσκευή πρέπει να εγκατασταθεί σύμφωνα με τους εθνικούς κανονισμούς περί καλωδιώσεων. Τυχόν ανεπάρκεια ικανότητας του κυκλώματος τροφοδοσίας ή ελλιπής εγκατάσταση ενδέχεται να προκαλέσει ηλεκτροπληξία ή πυρκαγιά.
- Να χρησιμοποιείτε καλωδιώσεις οι οποίες πληρούν τις προδιαγραφές του Εγχειριδίου Εγκατάστασης και τις απαιτήσεις των τοπικών κανονισμών και νομοθεσίας. Η χρήση καλωδιώσεων οι οποίες δεν πληρούν τις προδιαγραφές ενδέχεται να προκαλέσει ηλεκτροπληξία, διαρροές ρεύματος, καπνό ή/και πυρκαγιά.
- Φροντίστε να συνδέσετε το καλώδιο της γείωσης. (εργασία γείωσης) Η ελλιπής γείωση προκαλεί ηλεκτροπληξία.
- Μην συνδέετε τα καλώδια γείωσης σε σωλήνες αερίου ή νερού, ράβδους αλεξικέραυνων ή σύρματα γείωσης τηλεφωνικών καλωδίων.
- Μόλις ολοκληρωθούν οι εργασίες επισκευής ή αλλαγής θέσης του κλιματιστικού, βεβαιωθείτε ότι τα καλώδια γείωσης έχουν συνδεθεί κατάλληλα.

- Φροντίστε για την εγκατάσταση αυτόματου διακόπτη κυκλώματος ο οποίος πληροί τις προδιαγραφές του Εγχειριδίου Εγκατάστασης και τις απαιτήσεις των τοπικών κανονισμών και νομοθεσίας.
- Εγκαταστήστε τον αυτόματο διακόπτη κυκλώματος σε σημείο όπου θα διευκολύνεται η πρόσβασή του από τον αντιπρόσωπο.
- Όταν πραγματοποιείτε εγκατάσταση του αυτόματου διακόπτη κυκλώματος σε εξωτερικό χώρο, φροντίστε για την εγκατάσταση διακόπτη κατάλληλου τύπου για εξωτερική χρήση.
- Σε καμία περίπτωση δεν επιτρέπεται προέκταση του καλωδίου τροφοδοσίας. Τυχόν προβλήματα σύνδεσης στα σημεία προέκτασης του καλωδίου ενδέχεται να προκαλέσουν καπνό ή/και πυρκαγιά.

Δοκιμαστική λειτουργία

- Μόλις ολοκληρωθούν οι εργασίες και πριν θέσετε το κλιματιστικό σε λειτουργία, βεβαιωθείτε ότι το κάλυμμα του κιβωτίου ηλεκτρικών εξαρτημάτων της εσωτερικής μονάδας και ο πίνακας σέρβις της εξωτερικής μονάδας είναι κλειστά και θέστε τον αυτόματο διακόπτη κυκλώματος στη θέση ON. Εάν δεν πραγματοποιήσετε πρώτα αυτούς τους ελέγχους, ενδέχεται να υποστείτε ηλεκτροπληξία σε περίπτωση που ενεργοποιηθεί η τροφοδοσία.
- Εάν παρατηρήσετε κάποιο πρόβλημα (όπως εμφάνιση ένδειξης ελέγχου, οσμή καμμένου, μη φυσιολογικούς θορύβους, το κλιματιστικό δεν ψύχει ούτε θερμαίνει ή παρουσιάζεται διαρροή νερού) στην λειτουργία του κλιματιστικού, μην αγνίζετε το κλιματιστικό εσείς οι ίδιοι αλλά θέστε τον διακόπτη κυκλώματος στη θέση OFF και απευθυνθείτε σε εξειδικευμένο τεχνικό σέρβις. Λάβετε μέτρα, ώστε να μην είναι εφικτή η ενεργοποίηση της παροχής τροφοδοσίας (αναρτώντας πινακίδα με την ένδειξη "εκτός λειτουργίας" κοντά στον αυτόματο διακόπτη κυκλώματος, για παράδειγμα), έως ότου φθάσει ο εξειδικευμένος τεχνικός σέρβις. Εάν συνεχίσετε τη χρήση του κλιματιστικού, όταν έχει παρουσιαστεί πρόβλημα, ενδέχεται να προκληθεί κλιμάκωση των μηχανικών προβλημάτων ή να καταλήξει σε ηλεκτροπληξία, κ.λ.π.

- Μόλις ολοκληρωθούν οι εργασίες, φροντίστε να χρησιμοποιήσετε κατάλληλη συσκευή για τον έλεγχο της μόνωσης (500 VMΩ) για να ελέγξετε εάν η αντίσταση είναι 1 MΩ ή περισσότερο μεταξύ ηλεκτροφόρου τμήματος και μη ηλεκτροφόρου μεταλλικού τμήματος (τμήμα γείωσης). Εάν η τιμή της αντίστασης είναι χαμηλή, προκαλείται σοβαρή ζημία στην πλευρά του χρήστη, όπως διαρροή ρεύματος ή ηλεκτροπληξία.
- Μόλις ολοκληρωθούν οι εργασίες εγκατάστασης, ελέγξτε για διαρροές ψυκτικού υγρού, την αντίσταση μόνωσης και την αποστράγγιση νερού. Στη συνέχεια, εκτελέστε δοκιμαστική λειτουργία ώστε να ελεγχθεί ότι το κλιματιστικό λειτουργεί κανονικά.
- Μετά τις εργασίες εγκατάστασης, βεβαιωθείτε ότι δεν υπάρχει διαρροή του ψυκτικού αερίου. Τυχόν διαρροή του ψυκτικού αερίου στο χώρο και κίνησή του κοντά σε πηγή φωτιάς, όπως εστία κουζίνας, ενδέχεται να δημιουργήσει επιβλαβείς αναθυμιάσεις.

Επεξηγήσεις που παρέχονται στο χρήστη

- Μόλις ολοκληρωθούν οι εργασίες εγκατάστασης, ενημερώστε το χρήστη για τη θέση του αυτόματου διακόπτη κυκλώματος. Εάν ο χρήστης δεν γνωρίζει που βρίσκεται ο αυτόματος διακόπτης κυκλώματος, δεν θα μπορεί να τον απενεργοποιήσει σε περίπτωση που παρουσιαστεί κάποιο πρόβλημα στο κλιματιστικό.
- Αν διαπιστώσετε ότι το προστατευτικό του ανεμιστήρα έχει βλάβη, μην πλησιάζετε την εξωτερική μονάδα, αλλά θέστε τον διακόπτη κυκλώματος στη θέση OFF και επικοινωνήστε με έναν εξειδικευμένο τεχνικό σέρβις(*1) για να προβεί στις απαραίτητες επισκευές. Μην θέσετε τον αυτόματο διακόπτη κυκλώματος στη θέση ON, εάν δεν ολοκληρωθούν οι επισκευές.
- Μόλις ολοκληρωθούν οι εργασίες εγκατάστασης, ακολουθήστε τις οδηγίες που αναγράφονται στο Εγχειρίδιο Κατόχου, για να εξηγήσετε στον πελάτη τον τρόπο χρήσης και συντήρησης της μονάδας.

Αλλαγή θέσης

- Η μεταφορά του κλιματιστικού σε άλλη θέση επιτρέπεται μόνον από εξειδικευμένο εγκαταστάτη(*1) ή εξειδικευμένο τεχνικό σέρβις(*1). Σε περίπτωση εγκατάστασης του κλιματιστικού από ανειδίκευτο άτομο, υπάρχει μεγάλος κίνδυνος να προκληθεί πυρκαγιά, ηλεκτροπληξία, τραυματισμός, διαρροή νερού, θόρυβος ή/και κραδασμοί.
- Κατά την εργασία περισυλλογής ψυκτικού υγρού, διακόψτε τη λειτουργία του συμπιεστή πριν από την αποσύνδεση του σωλήνα ψυκτικού υγρού. Εάν ο σωλήνας ψυκτικού αποσυνδεθεί ενώ ο συμπιεστής βρίσκεται σε λειτουργία με τη βαλβίδα ανοιχτή, ο συμπιεστής αναρροφά αέρα και η πίεση στη διάρκεια του κύκλου ψύξης αυξάνει σε μη φυσιολογικά επίπεδα, πράγμα το οποίο ενδέχεται να προκαλέσει έκρηξη, τραυματισμό, κ.λ.π.

(*1) Ανατρέξτε στην ενότητα "Ορισμός Εξειδικευμένου Εγκαταστάτη ή Εξειδικευμένου Τεχνικού Σέρβις".

⚠ ΠΡΟΣΟΧΗ

Αυτό το κλιματιστικό χρησιμοποιεί το ψυκτικό HFC (R32) το οποίο δεν καταστρέφει τη στιβάδα του όζοντος

- Το ψυκτικό R32 έχει υψηλή πίεση εργασίας και επηρεάζεται από ακαθαρσίες όπως νερό, οξειδωτική μεμβράνη και λάδια. Συνεπώς, κατά τη διάρκεια των εργασιών εγκατάστασης, προσέχετε ώστε να μην εισχωρήσει νερό, σκόνη, παλαιότερο ψυκτικό, λάδι ψύξης μηχανημάτων ή άλλες ουσίες μέσα στον κύκλο ψύξης R32.
- Για την εγκατάσταση απαιτούνται ειδικά εργαλεία για ψυκτικό R32 ή R410A.
- Για τη σύνδεση των σωλήνων, χρησιμοποιήστε καινούρια και καθαρά υλικά σωληνώσεων και βεβαιωθείτε ότι δεν εισέρχεται νερό ή/και σκόνη.

Επισημάνσεις προσοχής για το χώρο εγκατάστασης της εξωτερικής μονάδας

- Στην περίπτωση που η εξωτερική μονάδα εγκατασταθεί σε μικρό χώρο και διαρρεύσει ψυκτικό, η συσσώρευση ψυκτικού υψηλής συγκέντρωσης μπορεί να προκαλέσει κίνδυνο πυρκαγιάς. Συνεπώς, βεβαιωθείτε να ακολουθήσετε τις οδηγίες για το χώρο εγκατάστασης που περιέχονται στο Εγχειρίδιο εγκατάστασης και να παρέχετε ανοικτό χώρο σε τουλάχιστον μία από τις τέσσερις πλευρές της εξωτερικής μονάδας.
- Συγκεκριμένα, όταν οι πλευρές εκκένωσης και εισόδου είναι στραμμένες σε τοίχους και επίσης υπάρχουν εμπόδια και στις δύο πλευρές της εξωτερικής μονάδας, λάβετε μέτρα για να παράσχετε χώρο αρκετά μεγάλο (600 mm ή περισσότερο) για να περνάει ένα άτομο από τη μία πλευρά, ώστε να αποφευχθεί η συσσώρευση διαρροής ψυκτικού.

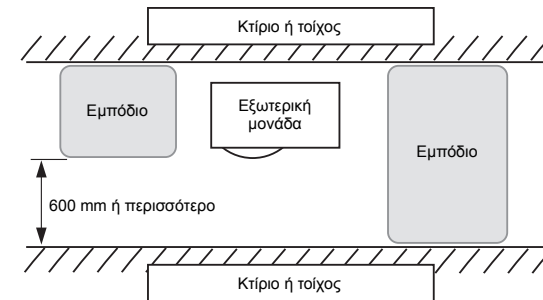

Για να αποσυνδέσετε την συσκευή από την κύρια τροφοδοσία ρεύματος

- Αυτή η συσκευή πρέπει να συνδεθεί στην κεντρική τροφοδοσία ρεύματος με έναν διακόπτη με διαχωριστή επαφής τουλάχιστον 3 mm. **Μην χρησιμοποιείτε πλυστικά υψηλής πίεσης για την έκπλυση των κλιματιστικών.**
- Τυχόν διαρροές ρεύματος ενδέχεται να προκαλέσουν ηλεκτροπληξία ή πυρκαγιά.

Благодарим вас за покупку кондиционера воздуха Toshiba.

Внимательно прочтите данные инструкции, которые содержат важную информацию, соответствующую директиве "Машины и механизмы" (Директива 2006/42/ЕС), и убедитесь, что они вам понятны. После того, как вы прочитаете данную инструкцию, обязательно сохраните ее в надежном месте вместе с Руководством пользователя и Руководством по установке, поставляемыми вместе с изделием.

Общее Обозначение: Кондиционер Воздуха

Определение квалифицированного установщика или квалифицированного специалиста

Только квалифицированный установщик или квалифицированный специалист должен устанавливать, обслуживать, ремонтировать и демонтировать кондиционер воздуха. Если необходимо провести какие-либо из вышеописанных работ, обратитесь к квалифицированному установщику или квалифицированному специалисту провести их за вас.

Квалифицированным установщиком или квалифицированным специалистом является исполнитель, имеющий квалификацию и знания, описанные в таблице ниже.

Исполнитель	Квалификация и знания, которыми должен обладать исполнитель
Квалифицированный установщик	<ul style="list-style-type: none"> • Квалифицированным установщиком является человек, который устанавливает, поддерживает, перемещает и демонтирует кондиционеры воздуха, изготовленные Toshiba Carrier Corporation. Он или она прошли подготовку, позволяющую им устанавливать, обслуживать, перемещать и демонтировать кондиционеры воздуха, изготовленные Toshiba Carrier Corporation, либо же он или она были обучены проведению данных операций человеком или людьми, которые прошли подготовку и поэтому обладают всеми необходимыми знаниями, касающимися данных операций. • Квалифицированный установщик, которому разрешено проводить электротехнические работы, связанные с установкой, перемещением и демонтажем, имеет соответствующую квалификацию для выполнения данных электротехнических работ, которая соответствует местным законам и правилам. Он или она прошли необходимую подготовку по проведению электротехнических работ для кондиционеров воздуха, изготовленных Toshiba Carrier Corporation, либо же он или она были обучены проведению данных операций человеком или людьми, которые прошли подготовку и поэтому обладают всеми необходимыми знаниями, касающимися данных работ. • Квалифицированный установщик, которому разрешено обращаться с хладагентом и осуществлять работы по прокладке трубопровода, связанные с установкой, перемещением и демонтажем, имеет соответствующую квалификацию для обращения с хладагентом и проведения работ по прокладке трубопровода, которая соответствует местным законам и правилам. Он или она прошли необходимую подготовку по обращению с хладагентом и прокладке трубопровода для кондиционеров воздуха, изготовленных Toshiba Carrier Corporation, либо же он или она были обучены проведению данных операций человеком или людьми, которые прошли подготовку и поэтому обладают всеми необходимыми знаниями, касающимися данных работ. • Квалифицированный установщик, которому разрешено проводить высотные работы, прошел необходимую подготовку для проведения высотных работ с кондиционерами воздуха, изготовленными Toshiba Carrier Corporation, либо же он или она были обучены проведению данных операций человеком или людьми, которые прошли подготовку и поэтому обладают всеми необходимыми знаниями, касающимися данных работ.

Квалифицированный специалист	<ul style="list-style-type: none"> • Квалифицированным специалистом является человек, который устанавливает, ремонтирует, поддерживает, перемещает и демонтирует кондиционеры воздуха, изготовленные Toshiba Carrier Corporation. Он или она прошли подготовку, позволяющую им устанавливать, ремонтировать, обслуживать, перемещать и демонтировать кондиционеры воздуха, изготовленные Toshiba Carrier Corporation, либо же он или она были обучены проведению данных операций человеком или людьми, которые прошли подготовку и поэтому обладают всеми необходимыми знаниями, касающимися данных операций. • Квалифицированный специалист, которому разрешено проводить электротехнические работы, связанные с установкой, ремонтом перемещением и демонтажем, имеет соответствующую квалификацию для выполнения данных электротехнических работ, которая соответствует местным законам и правилам. Он или она прошли необходимую подготовку по проведению электротехнических работ для кондиционеров воздуха, изготовленных Toshiba Carrier Corporation, либо же он или она были обучены проведению данных операций человеком или людьми, которые прошли подготовку и поэтому обладают всеми необходимыми знаниями, касающимися данных работ. • Квалифицированный специалист, которому разрешено обращаться с хладагентом и осуществлять работы по прокладке трубопровода, связанные с установкой, ремонтом, перемещением и демонтажем, имеет соответствующую квалификацию для обращения с хладагентом и проведения работ по прокладке трубопровода, которая соответствует местным законам и правилам. Он или она прошли необходимую подготовку по обращению с хладагентом и прокладке трубопровода для кондиционеров воздуха, изготовленных Toshiba Carrier Corporation, либо же он или она были обучены проведению данных операций человеком или людьми, которые прошли подготовку и поэтому обладают всеми необходимыми знаниями, касающимися данных работ. • Квалифицированный специалист, которому разрешено проводить высотные работы, прошел необходимую подготовку для проведения высотных работ с кондиционерами воздуха, изготовленными Toshiba Carrier Corporation, либо же он или она были обучены проведению данных операций человеком или людьми, которые прошли подготовку и поэтому обладают всеми необходимыми знаниями, касающимися данных работ.
------------------------------	---

Определение защитной экипировки

При перевозке, установке, обслуживании, ремонте или демонтаже кондиционера воздуха, надевайте защитные перчатки и "безопасную" рабочую одежду.

В дополнение к обычной защитной экипировке, одевайте защитную экипировку, описанную ниже, при выполнении специальных работ, приведенных в таблице ниже.

Отсутствие необходимой защитной экипировки опасно, поскольку вы будете более подвержены травмам, ожогам, поражению электрическим током или другим травмам.

Проводимые работы	Защитная экипировка
Все типы работ	Защитные перчатки "Безопасная" рабочая одежда
Электротехнические работы	Перчатки, обеспечивающие защиту от удара электрическим током Диэлектрическая обувь Одежда, обеспечивающая защиту от поражения электрическим током
Высотные работы (50 см или более)	Каски, применяемые в отрасли
Перевозка тяжелых предметов	Ботинки с дополнительным защитным носком
Ремонт внешнего блока	Перчатки, обеспечивающие защиту от удара электрическим током

■ Центр тяжести

(Единица измерения: мм)

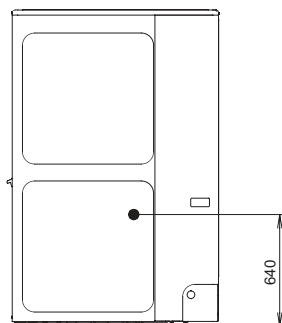
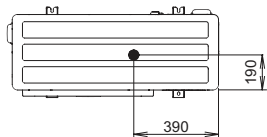

Настоящие меры предосторожности описывают важные аспекты, касающиеся безопасности и направленные на предотвращение травм пользователей или других людей и ущерба имуществу. Полностью прочитайте данное руководство, предварительно изучив приведенную ниже информацию (значение обозначений), и следуйте описанию.





Обозначение	Значение обозначений
ПРЕДУПРЕЖДЕНИЕ	Текст, отмеченный таким образом, указывает, что несоблюдение указаний в предупреждении может привести к серьезному телесному повреждению (*1) или смерти в случае неправильного обращения с изделием.
ВНИМАНИЕ	Текст, отмеченный таким образом, указывает, что несоблюдение указаний в предостережении может привести к легкому телесному повреждению (*2) или повреждению имущества (*3) в случае неправильного обращения с изделием.



*1: Серьезное телесное повреждение включает потерю зрения, травму, ожоги, поражение электрическим током, перелом, отравление и другие повреждения, имеющие последствия и требующие госпитализации или длительного амбулаторного лечения.

*2: Легкое телесное повреждение включает травму, ожоги, поражение электрическим током и другие повреждения, не требующие госпитализации или длительного амбулаторного лечения.

*3: Повреждение имущества включает повреждение зданий, домашнего имущества, домашнего скота и домашних питомцев.

■ Предупредительные указатели на кондиционере воздуха

	ПРЕДУПРЕЖДЕНИЕ (Опасность возгорания)	Это обозначение относится только к хладагенту R32. Тип хладагента указан на паспортной табличке наружного блока. В случае использования хладагента R32 настоящее оборудование использует огнеопасный хладагент. В случае утечки хладагента и его контакте с огнем или нагревательным элементом образуется вредный газ и возникает опасность возгорания.
	Перед эксплуатацией внимательно прочитайте руководство по эксплуатации.	
	Технический персонал перед проведением работ должен внимательно прочитать руководство по эксплуатации и руководство по установке.	
	Более подробная информация приведена в руководстве по эксплуатации, руководстве по установке и других аналогичных документах.	

Предупредительный указатель	Описание		
 <table border="1"> <tr> <td>WARNING</td> </tr> <tr> <td>ELECTRICAL SHOCK HAZARD Disconnect all remote electric power supplies before servicing.</td> </tr> </table>	WARNING	ELECTRICAL SHOCK HAZARD Disconnect all remote electric power supplies before servicing.	ПРЕДУПРЕЖДЕНИЕ ПОРАЖЕНИЕ ЭЛЕКТРИЧЕСКИМ ТОКОМ Перед обслуживанием отключите все внешние источники питания.
WARNING			
ELECTRICAL SHOCK HAZARD Disconnect all remote electric power supplies before servicing.			
 <table border="1"> <tr> <td>WARNING</td> </tr> <tr> <td>Moving parts. Do not operate unit with grille removed. Stop the unit before the servicing.</td> </tr> </table>	WARNING	Moving parts. Do not operate unit with grille removed. Stop the unit before the servicing.	ПРЕДУПРЕЖДЕНИЕ Подвижные части. Не эксплуатируйте устройство со снятой решеткой. Выключите устройство перед обслуживанием.
WARNING			
Moving parts. Do not operate unit with grille removed. Stop the unit before the servicing.			
 <table border="1"> <tr> <td>CAUTION</td> </tr> <tr> <td>High temperature parts. You might get burned when removing this panel.</td> </tr> </table>	CAUTION	High temperature parts. You might get burned when removing this panel.	ВНИМАНИЕ Горячие детали. Вы можете получить ожоги при снятии данной панели.
CAUTION			
High temperature parts. You might get burned when removing this panel.			

 <table border="1"> <tr> <td>CAUTION</td> </tr> <tr> <td>Do not touch the aluminum fins of the unit. Doing so may result in injury.</td> </tr> </table>	CAUTION	Do not touch the aluminum fins of the unit. Doing so may result in injury.	ВНИМАНИЕ Не прикасайтесь к алюминиевым пластинам устройства. Это может привести к травмам.
CAUTION			
Do not touch the aluminum fins of the unit. Doing so may result in injury.			
 <table border="1"> <tr> <td>CAUTION</td> </tr> <tr> <td>BURST HAZARD Open the service valves before the operation, otherwise there might be the burst.</td> </tr> </table>	CAUTION	BURST HAZARD Open the service valves before the operation, otherwise there might be the burst.	ВНИМАНИЕ ОПАСНОСТЬ ВЗРЫВА Откройте клапаны обслуживания перед эксплуатацией, иначе может произойти взрыв.
CAUTION			
BURST HAZARD Open the service valves before the operation, otherwise there might be the burst.			

1 МЕРЫ ПРЕДОСТОРОЖНОСТИ

Производитель не несет никакой ответственности за ущерб, понесенный в результате несоблюдения описания в данном руководстве.

ПРЕДУПРЕЖДЕНИЕ

Общие положения

- Перед началом установки кондиционера воздуха внимательно прочитайте Руководство по установке и следуйте приведенным там инструкциям для установки кондиционера воздуха.
- Только квалифицированный установщик(*1) или квалифицированный специалист(*1) может устанавливать кондиционер воздуха. Если кондиционер воздуха устанавливается неспециалистом, то это может привести к пожару, поражению электрическим током, травмам, протечке воды, возникновению шума и/или вибраций.
- Не используйте какой-либо другой хладагент, отличный от указанного, для пополнения или замены. В противном случае в контуре охлаждения может генерироваться аномально высокое давление, что может привести к сбоям в работе или взрыву изделия, а также к травмам.
- При транспортировке кондиционера используйте вилочный погрузчик, а при перемещении вручную кондиционер переносят 4 человека.
- Перед тем, как открывать решетку забора внутреннего блока или сервисную панель внешнего блока, установите прерыватель питания в положение OFF. Если прерыватель питания не переведен в положение OFF, это может привести к поражению электрическим током в результате соприкосновения с внутренними деталями. Только квалифицированный установщик(*1) или квалифицированный специалист(*1) может снимать решетку забора внутреннего блока или сервисную панель внешнего блока, и выполнять необходимые работы.

- Перед выполнением работ по установке, обслуживанию, ремонту или демонтажу обязательно установите прерыватель питания в положение OFF. Иначе может произойти поражение электрическим током.
- Поместите рядом с прерывателем питания знак “Ведутся работы”, пока выполняются работы по установке, обслуживанию, ремонту или демонтажу. Если прерыватель питания по ошибке будет переведен в положение ON, существует опасность поражения электрическим током.
- Только квалифицированный монтажник(*1) или квалифицированный специалист по обслуживанию(*1) может выполнять высотные работы, используя опору 50 см или выше.
- Одевайте защитные перчатки и безопасную одежду во время работ по установке, обслуживанию и демонтажу.
- Не прикасайтесь к алюминиевой пластине внешнего блока. Это может привести к травмам. Если необходимо дотронуться до пластины, сначала наденьте защитные перчатки и безопасную рабочую одежду и только после этого приступайте к работе.
- Не забирайтесь на внешний блок и не кладите на него никаких вещей. Вы можете упасть, или же эти предметы могут свалиться с наружного блока и причинить травму.
- При высотных работах используйте лестницу, соответствующую стандарту ISO 14122, и следуйте процедуре, описанной в инструкциях к лестнице. Также надевайте каску, применяемую в отрасли, в качестве защитной экипировки при работах.
- При проведении высотных работ, установите на месте работ знак, перед тем, как приступать к работе, чтобы никто не приближался к месту проведения работ. Детали и другие предметы могут упасть с высоты и возможно привести к травмам человека, стоящего внизу.
- Убедитесь, что кондиционер воздуха перевозится в устойчивом положении. Если сломана любая из деталей изделия, обратитесь к дилеру.

- Запрещается модифицировать данные изделия. Запрещается разбирать или модифицировать детали. Это может привести к возгоранию, поражению электрическим током или травме.
- Прибор предназначен для использования специалистами или обученными пользователями в магазинах, в легкой промышленности, а также для коммерческого использования неспециалистами.

О хладагенте

- Данное изделие содержит фторсодержащие парниковые газы.
- Не выпускайте эти газы в атмосферу.
- Устройство следует хранить в помещении без постоянно работающих источников воспламенения (например, открытого пламени, работающего газового прибора или работающего электрического нагревателя).
- Не прокалывайте и не сжигайте детали, контактирующие с хладагентом.
- Не используйте устройства для ускорения процесса размораживания или очистки, отличные от рекомендуемых производителем.
- Следует иметь в виду, что хладагенты могут не иметь запаха.
- Хладагент, находящийся внутри блока, огнеопасен. Утечка хладагента в помещении и его контакт с пламенем горелки, нагревателем или плитой может привести к образованию вредного газа.
- Отключите все нагревательные устройства, использующие горение, проветрите помещение и обратитесь к дилеру, у которого было приобретено оборудование.
- Не используйте оборудование до получения подтверждения от технического персонала о завершении ремонта узла, из которого произошла утечка хладагента.

- При установке, перемещении и обслуживании кондиционера для заполнения трубопроводов хладагента используйте только указанный хладагент (R32). Не смешивайте его с другими хладагентами и не допускайте, чтобы в трубопроводах оставался воздух.
- Трубопроводы следует защищать от физического повреждения.
- Следует соблюдать требования национальных норм, касающихся работы газами.

Выбор места установки

- Если вы устанавливаете устройство в небольшом помещении, примите необходимые меры к тому, чтобы хладагент не превысил предельной концентрации, даже если он протечет. Проконсультируйтесь с дилером, у которого вы купили кондиционер воздуха, при принятии данных мер. Скопление высококонцентрированного хладагента может привести к несчастному случаю вследствие кислородной недостаточности.
- Не устанавливайте кондиционер воздуха в местах, где есть риск утечки горючего газа. В случае утечки воспламеняющегося газа и концентрации его вокруг блока, может произойти возгорание.
- При перевозке кондиционера одевайте обувь с дополнительным защитным носком.
- При перевозке кондиционера воздуха не беритесь за стяжные ленты упаковочного картона. Вы можете травмироваться, если ленты порвутся.
- Не помещайте приборы, использующие открытое горение, в местах, где они могут непосредственно находиться под воздействием потока воздуха от кондиционера воздуха. Иначе это может привести к неполному сгоранию.
- Не устанавливайте кондиционер в плохо проветриваемом помещении, площадь которого меньше минимальной площади помещения (Амин).
Это относится к:
 - внутренним блокам;

- установленным наружным блокам (например в зимнем саду, гараже, машинном зале и других аналогичных помещениях).

Для определения минимальной площади см. “ПРИЛОЖЕНИЕ 15 – [2] Минимальная площадь помещения: Амин (м²)”.

Установка

- Устанавливайте кондиционер воздуха в местах, достаточно прочных, чтобы выдержать вес устройства. Если прочность будет недостаточной, устройство может упасть, что приведет к травмам.
- Чтобы установить кондиционер воздуха, следуйте инструкциям Руководства по установке. Если не следовать данным инструкциям, то изделие может упасть, перевернуться, либо появятся шум, вибрация, протечка воды и пр.
- При установке внешнего блока должны использоваться специально предназначенные для этого болты (M10) и гайки (M10).
- Устанавливайте внешний блок в месте, которое имеет достаточную прочность, чтобы поддерживать его вес. Недостаточная прочность опоры может повлечь падение внешнего блока и травм.
- В случае утечки газообразного хладагента во время установки немедленно проветрите помещение. При контакте газообразного хладагента с огнем может образоваться токсичный газ.
- Объем монтажа трубопроводов следует сводить к минимуму.

Прокладка трубопровода контура охлаждения

- Перед запуском кондиционера воздуха надежно закрепите трубопровод хладагента. Если компрессор работает с открытым клапаном и без трубопровода, компрессор подсасывает воздух и в контуре охлаждения давление поднимается выше нормы, что может привести к травмам.
- Затягивайте накидную гайку динамометрическим ключом так, как указано в руководстве. Перенатяжение накидной гайки может привести к тому, что с течением времени на ней образуется трещина, вследствие чего может произойти утечка хладагента.

- При выполнении работ по установке и перемещению следуйте указаниям, приведенным в руководстве по установке, и используйте инструменты и узлы трубопроводов, предназначенные для работы с хладагентом R32. В случае использования узлов трубопроводов, не предназначенных для хладагента R32, или неправильной установки оборудования трубопроводы могут взорваться и привести к повреждениям или травмам. Кроме того, может возникнуть утечка воды, поражение электрическим током или возгорание.
- Для проверки герметичности должен использоваться азот.
- Зарядный шланг должен быть подключен таким образом, чтобы он не провисал.

Электропроводка

- Только квалифицированный установщик(*1) или квалифицированный специалист(*1) может выполнять электротехнические работы с кондиционером воздуха. Ни в коем случае данные работы не должны производиться неспециалистом, поскольку неправильное выполнение работ может привести к поражению электрическим током и/или утечкам тока.
- Устройство устанавливается в соответствии с национальными правилами электропроводки. Недостаточные характеристики цепи питания или неполная установка может привести к поражению электрическим током или пожару.
- Используйте проводку, которая соответствует спецификации, приведенной в Руководстве по установке и положениям местных законов и правил. Использование проводки, не соответствующей спецификации, может привести к поражению электрическим током, утечке тока, задымлению и/или пожару.
- Обязательно подключайте провод заземления. (Работы по заземлению)
Неполное заземление приводит к поражению электрическим током.
- Не замыкайте провода заземления на газовые или водопроводные трубы, громоотводы или провода заземления телефонных линий.

- После завершения работ по ремонту или перемещению проверьте, что провода заземления подключены надлежащим образом.
- Устанавливайте прерыватель питания, который соответствует спецификации, приведенной в Руководстве по установке и положениям местных законов и правил.
- Устанавливайте прерыватель питания в таком месте, где бы он мог быть легко доступен пользователю.
- При установке прерывателя питания вне помещения, установите прерыватель, который специально предназначен для использования на открытом воздухе.
- Ни в коем случае нельзя наращивать силовой кабель питания. Проблемы соединения в местах, где кабель был наращен, могут привести к задымлению и/или пожару.

Пробный пуск

- После окончания работ и перед эксплуатацией кондиционера воздуха, проверьте, что крышка отделения электрических частей внутреннего блока и сервисная панель внешнего блока закрыты, и установите прерыватель питания в положение ON. Если включить питание до проведения данных проверок, это может привести к поражению электрическим током.
- Если обнаружили какие-либо неполадки в работе кондиционера (например, загорелся контрольный индикатор, появился запах гари, слышны нехарактерные звуки, кондиционер не охлаждает или не нагревает воздух, подтекает вода) — не трогайте кондиционер самостоятельно, переведите его сетевой выключатель в положение выключения OFF и вызовите квалифицированного специалиста по обслуживанию. Примите меры к тому, чтобы до прибытия квалифицированного специалиста питание не включалось (например, пометкой “Неисправно” около прерывателя питания). Продолжение использования кондиционера воздуха при имеющихся неполадках может усугубить механические проблемы или привести к поражению электрическим током и пр.

- После окончания работ, обязательно используйте измеритель сопротивления изоляции (500 ВМОм), чтобы проверить, что сопротивление между секцией зарядки и металлической секцией без зарядки (секция заземления) составляет 1 МΩ или более. Если сопротивление низкое, то может произойти несчастный случай, например, утечка или поражение электрическим током на стороне пользователя.
- После окончания работ по установке проверьте возможные утечки хладагента, сопротивление изоляции и дренаж воды. Затем проведите пробный пуск, чтобы проверить, что кондиционер воздуха работает должным образом.
- По окончании установки убедитесь в отсутствии утечек газообразного хладагента. Утечка хладагента и формирование его потока в непосредственной близости от источников огня, например, кухонной плиты, может приводить к образованию токсичного газа.

Объяснения пользователю

- После окончания работ по установке покажите пользователю где находится прерыватель питания. Если пользователь не знает где находится прерыватель питания, он или она не смогут выключить устройство в случае каких-либо проблем с кондиционером воздуха.
- При обнаружении повреждения ограждения вентилятора не подходите к наружному блоку, а установите сетевой выключатель в положение OFF и свяжитесь с квалифицированным специалистом по обслуживанию(*1) для проведения ремонта. До окончания ремонта не возвращайте сетевой выключатель в положение ON.
- После проведения работ по установке следуйте Руководству пользователя, чтобы объяснить покупателю как использовать и обслуживать устройство.

Перемещение

- Только квалифицированный установщик(*1) или квалифицированный специалист(*1) может перемещать кондиционер воздуха. Перемещение кондиционера воздуха неспециалистом опасно, поскольку может привести к пожару, поражению электрическим током, травмам, протечкам воды, возникновению шума и/или вибраций.
- При проведении работ по откачке выключите компрессор перед тем, как отключать трубопровод. Отключение трубопровода при открытом сервисном клапане и включенном компрессоре приведет к засасыванию воздуха и пр., повышению давления в контуре охлаждения до ненормально высоких значений, и возможно к разрыву, травмам, и пр.

(*1) Смотрите "Определение квалифицированного установщика или квалифицированного специалиста".

⚠ ВНИМАНИЕ

В этом кондиционере используется гидрофторуглеродный (HFC) хладагент (R32), который не разрушает озоновый слой

- Хладагент R32 работает под высоким давлением и подвержен воздействию примесей, таких как вода, окислительная мембрана и масла. Поэтому при проведении работ по установке примите меры, чтобы вода, пыль, ранее использовавшийся хладагент, машинное масло холодильной машины и другие вещества не попадали в контур хладагента R32.
- При установке для хладагента R32 или R410A требуются специальные инструменты.
- Для соединения труб используйте новые и чистые материалы для изготовления труб и убедитесь, что на них не попадают вода и/или пыль.

Меры предосторожности, касающиеся места установки наружного блока

- При установке наружного блока в ограниченном пространстве в случае утечки хладагента накопление хладагента в высокой концентрации может вызывать опасность возгорания. Поэтому обязательно следуйте указаниям по месту установки, приведенным в руководстве по установке, и обеспечьте свободное пространство по крайней мере возле одной из четырех сторон наружного блока.
- В частности, когда возле сторон выпуска и забора воздуха находятся стены, а возле двух других сторон наружного блока находятся препятствия, примите меры по обеспечению свободного пространства достаточной ширины для прохода человека (600 мм или более) с одной стороны, чтобы предотвратить накопление утечек хладагента.

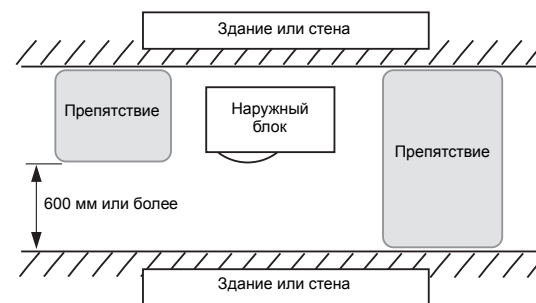





Для отключения устройства от источника питания

- Данное устройство должно подключаться к источнику питания с помощью выключателя с зазором между разомкнутыми контактами не менее 3 мм.

Не мойте кондиционеры воздуха с помощью моечных машин высокого давления.

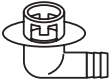
- Утечка тока может привести к поражению электрическим током или возгоранию.

2 ACCESSORY PARTS

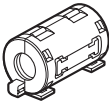
Part name	Q'ty	Shape	Usage
Installation manual	1		Hand this directly to the customer. (For other languages that do not appear in this Installation Manual, please refer to the enclosed CD-R.)
CD-ROM	1	—	Installation manual
Drain nipple	1		
Waterproof rubber cap	5		
Protective bush	1		For protecting wires (pipe cover)
Guard material for passage part	1		For protecting passage part (pipe cover)
Clamp filter	1		For conforming to EMC standards (Used for power wire)

3 INSTALLATION OF R32 REFRIGERANT AIR CONDITIONER

CAUTION

R32 refrigerant air conditioner installation

- This air conditioner adopts the HFC refrigerant (R32) which does not destroy ozone layer. Therefore, during installation work, make sure that water, dust, former refrigerant, or refrigerant oil does not enter the R32 refrigerant air conditioner cycle. To prevent mixing of refrigerant or refrigerant oil, the sizes of connecting sections of charge port on the main unit and installation tools are different from those of the conventional refrigerant units. Accordingly, special tools are required for the R32 or R410A refrigerant units. For connecting pipes, use new and clean piping materials with high pressure fittings made for the R32 or R410A only, so that water and/or dust does not enter.
- When using existing piping, refer to “15 APPENDIX - [1] Existing piping”.







■ Required Tools/Equipment and Precautions for Use

Prepare the tools and equipment listed in the following table before starting the installation work. Newly prepared tools and equipment must be used exclusively.

Legend

 : Conventional tools (R32 or R410A)

 : Prepared newly (Use for R32 only)

Tools / equipment	Use	How to use tools / equipment
Gauge manifold	Vacuuming / charging refrigerant and operation check	 Conventional tools (R410A)
Charging hose		 Conventional tools (R410A)
Charging cylinder	Cannot be used	Unusable (Use the electronic refrigerant charging scale)
Gas leak detector	Charging refrigerant	 Conventional tools (R32 or R410A)
Vacuum pump	Vacuum drying	 Conventional tools (R32 or R410A) Usable if the backflow prevention adapter is installed.
Vacuum pump with backflow prevention function	Vacuum drying	 Conventional tools (R32 or R410A)
Flare tool	Flare machining of pipes	 Conventional tools (R410A)

4 INSTALLATION CONDITIONS

Bender	Bending pipes	△ Conventional tools (R410A)
Refrigerant recovery equipment	Refrigerant recovery	△ Conventional tools (R32 or R410A)
Torque wrench	Tightening flare nuts	△ Conventional tools (R410A)
Pipe cutter	Cutting pipes	△ Conventional tools (R410A)
Refrigerant cylinder	Charging refrigerant	⊙ Prepared newly (Use for R32 only)
Welding machine and nitrogen cylinder	Welding pipes	△ Conventional tools (R410A)
Electronic refrigerant charging scale	Charging refrigerant	△ Conventional tools (R32 or R410A)

■ Refrigerant Piping

R32 refrigerant

⚠ CAUTION

- Incomplete flaring may cause refrigerant gas leakage.
- Do not re-use flares. Use new flares to prevent refrigerant gas leakage.
- Use flare nuts that are included with the unit. Using different flare nuts may cause refrigerant gas leakage.

Use the following item for the refrigerant piping.
Material : Seamless phosphorous deoxidized copper pipe.
ø6.35, ø9.52, ø12.7 Wall thickness 0.8 mm or more
ø15.88 Wall thickness 1.0 mm or more

REQUIREMENT

When the refrigerant pipe is long, provide support brackets at intervals of 2.5 to 3 m to clamp the refrigerant pipe. Otherwise, abnormal sound may be generated.

■ Before Installation

Be sure to prepare to the following items before installation.

Length of refrigerant pipe

Length of refrigerant pipe connected to indoor/outdoor unit	Height difference (Indoor-outdoor)		Item
	Indoor unit: Upper	Outdoor unit: Lower	
3 to 75 m	30 m	30 m	Addition of refrigerant at the local site is unnecessary for refrigerant pipe lengths up to 30 m. If the refrigerant pipe length exceeds 30 m, add refrigerant in the amount given in "Charging additional refrigerant".

- * Caution during addition of refrigerant
Charge the refrigerant accurately. Overcharging may cause serious trouble with the compressor.
- Do not connect a refrigerant pipe that is shorter than **3 m**.
This may cause a malfunction of the compressor or other devices.

■ Airtight Test

1. Before starting an airtight test, further tighten the spindle valves on the gas and liquid sides.
2. Pressurize the pipe with nitrogen gas charged from the service port to the design pressure (4.15 MPa) to conduct an airtight test.
3. After the airtight test is completed, evacuate the nitrogen gas.

Air purge

- To purge air, use a vacuum pump.
- Do not use refrigerant charged in the outdoor unit to purge air. (The air purge refrigerant is not contained in the outdoor unit.)

Electrical wiring

- Be sure to fix the power wires and indoor/outdoor connecting wires with clamps so that they do not come into contact with the cabinet, etc.

Earthing

WARNING

Make sure that proper earthing is provided.

Improper earthing may cause an electric shock. For details on how to check earthing, contact the dealer who installed the air conditioner or a professional installation company.

- Proper earthing can prevent charging of electricity on the outdoor unit surface due to the presence of a high frequency in the frequency converter (inverter) of the outdoor unit, as well as prevent electric shock. If the outdoor unit is not properly earthed, you may be exposed to an electric shock.
- **Be sure to connect the earth wire. (Grounding work)**
Incomplete earthing can cause an electric shock. Do not connect earth wires to gas pipes, water pipes, lightning rods or earth wires for telephone wires.

Test Run

Turn on the leakage breaker at least 12 hours before starting a test run to protect the compressor during startup.

CAUTION

Incorrect installation work may result in a malfunction or complaints from customers.

Installation Location

WARNING

Install the outdoor unit properly in a location that is durable enough to support the weight of the outdoor unit.

Insufficient durability may cause the outdoor unit to fall, which may result in injury.
Pay special attention when installing the unit onto a wall surface.

CAUTION

Do not install the outdoor unit in a location that is subject to combustible gas leaks.

Accumulation of combustible gas around the outdoor unit may cause a fire.

Install the outdoor unit in a location that meets the following conditions after the customer's consent is obtained.

- A well-ventilated location free from obstacles near the air inlets and air outlet
- A location that is not exposed to rain or direct sunlight
- A location that does not increase the operating noise or vibration of the outdoor unit
- A location that does not produce any drainage problems from discharged water

Do not install the outdoor unit in the following locations.

- A location with a saline atmosphere (coastal area) or one that is full of sulfide gas (hot-spring area) (Special maintenance is required.)
- A location subject to oil, vapor, oily smoke, or corrosive gases
- A location in which organic solvent is used
- Places where iron or other metal dust is present. If iron or other metal dust adheres to or collects on the interior of the air conditioner, it may spontaneously combust and start a fire.

- A location where high-frequency equipment (including inverter equipment, private power generator, medical equipment, and communication equipment) is used (Installation in such a location may cause malfunction of the air conditioner, abnormal control or problems due to noise from such equipment.)
- A location in which the discharged air of the outdoor unit blows against the window of a neighboring house
- A location where the operating noise of the outdoor unit is transmitted
- When the outdoor unit is installed in an elevated position, be sure to secure its feet.
- A location in which drain water poses any problems.

CAUTION

1. Install the outdoor unit in a location where the discharge air is not blocked.
2. When an outdoor unit is installed in a location that is always exposed to strong winds like a coast or on the high stories of a building, secure normal fan operation by using a duct or wind shield.
3. When installing the outdoor unit in a location that is constantly exposed to strong winds such as on the upper stairs or rooftop of a building, apply the windproofing measures referred to in the following examples.
 - 1) Install the unit so that its discharge port faces the wall of the building.
Keep a distance 500 mm or more between the unit and wall surface.

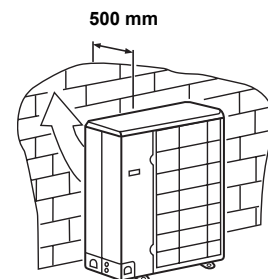

- 2) Consider the wind direction during the operational season of the air conditioner, and install the unit so that the discharge port is set at a right angle relative to the wind direction.

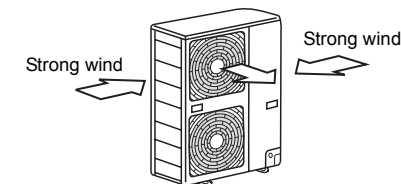

- When using an air conditioner under low outside temperature conditions (outside temp. -5 °C or lower) in COOL mode, prepare a duct or snow hood so that it is not affected by the snow.

<Example>

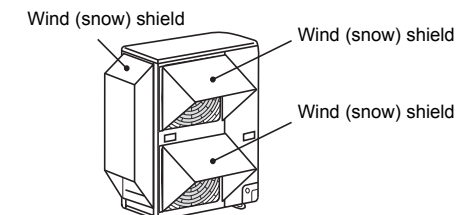

■ Necessary Space for Installation (Unit: mm)

Single unit installation

When there is an obstacle on the back side
(Front, sides, and top are free)

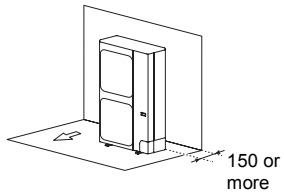

When there is an obstacle on the front side
(Back, sides, and top are free)

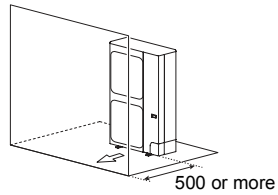

When there are obstacles on the front and back sides
(Sides and top are free)

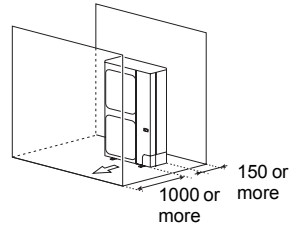

When there are obstacles on the top and front sides
(Back and sides are free)

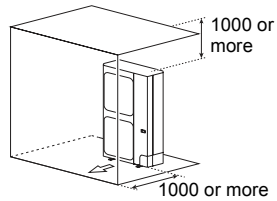

When there are obstacles on the back and top sides
(Front and sides are free)

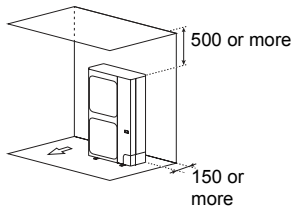

When there are obstacles on the back and sides
(Front and top are free)
* The height of the obstacle should be lower than that of the outdoor unit.

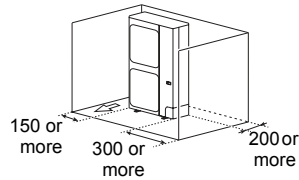

Serial unit installation

* When the outdoor temperature is high, the cooling capability may be decreased because of an equipment protection operation.

When there is an obstacle on the back side
(Front, sides, and top are free)

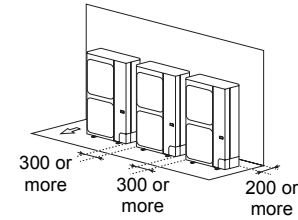

When there are obstacles on the back and top sides
(Front and sides are free)

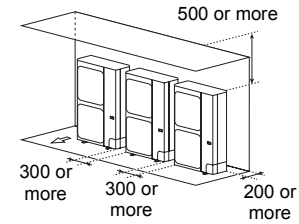

When there is an obstacle on the front side
(Back, sides, and top are free)

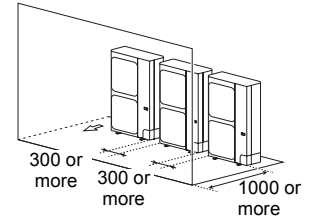

When there are obstacles on the back and sides
(Front and top are free)

* The height of the obstacle should be lower than that of the outdoor unit.

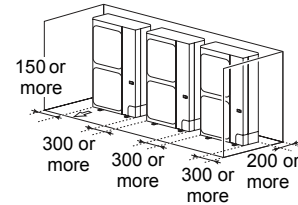

When there are obstacles on the front and back sides
(Sides and top are free)

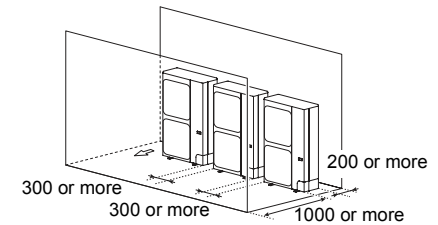

Single unit multiple-row installation
(Top and both sides are free)

* The height of the obstacle should be lower than that of the outdoor unit.

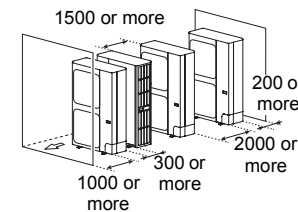

Multiple unit multiple-row installation
(Top, both sides, and front are free)

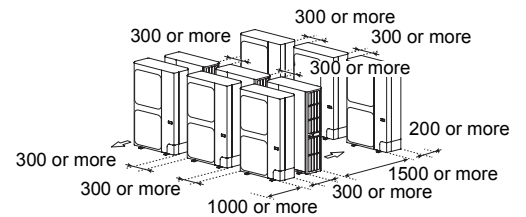

■ Installation of Outdoor Unit

- Before installation, check the strength and horizontalness of the base so that abnormal sounds do not emanate.
- According to the following base diagram, fix the base firmly with the anchor bolts.
(Anchor bolt, nut: M10 x 4 pairs)

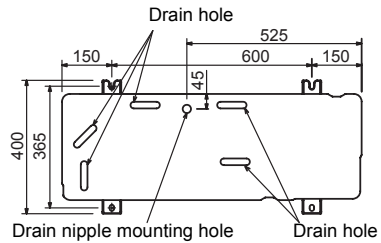

- As shown in the figure below, install the foundation and vibration-proof rubber pads to directly support the bottom surface of the fixing leg that is in contact with and underneath the bottom plate of the outdoor unit.
- * When installing the foundation for an outdoor unit with downward piping, consider the piping work.

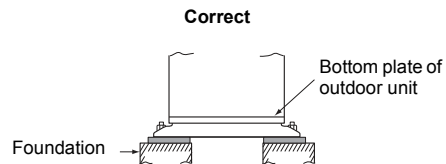
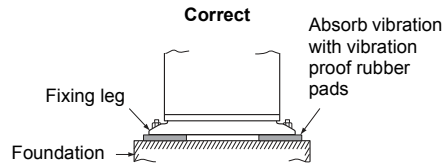

Support the bottom surface of the fixing leg that is in contact with and underneath the bottom plate of the outdoor unit.

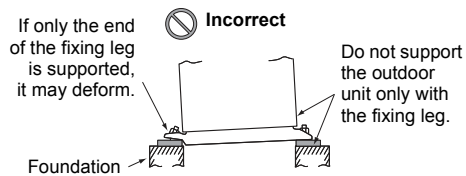

Set the out margin of the anchor bolt to 15 mm or less.

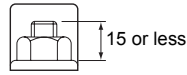

- When water is to be drained through the drain hose, attach the following drain nipple and waterproof rubber cap, and use the drain hose (Inner diam: 16 mm) sold on the market. Also seal knockout hole and the screws securely with silicone material, etc., to prevent water from leaking. Some conditions may cause dewing or dripping of water.
- When collectively draining discharged water completely, use a drain pan.

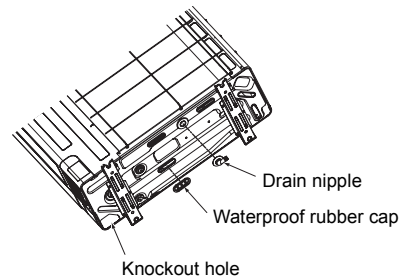
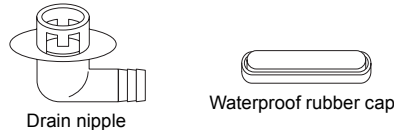

■ For Reference

If a heating operation is to be continuously performed for a long time under the condition that the outdoor temperature is 0 °C or lower, draining defrosted water may be difficult due to the bottom plate freezing, resulting in trouble with the cabinet or fan. It is recommended to procure an anti-freeze heater locally in order to safely install the air conditioner. For details, contact the dealer.

5 REFRIGERANT PIPING

■ Refrigerant Piping

1. Use the following items for the refrigerant piping.
Material : Seamless phosphorous deoxidized copper pipe.
ø6.35, ø9.52, ø12.7 Wall thickness 0.8 mm or more
ø15.88 Wall thickness 1.0 mm or more
Do not use any copper pipes with a wall thickness less than these thicknesses.

Removing service panel

- Remove the screws at 3 locations and slide the service panel down. Next, detach the right-side claws followed by left-side claws to remove the service panel. When doing this, pulling the service panel towards the front could damage the claws. When attaching the service panel, attach the left claws followed by the right claws and lift the service panel upwards and secure it with screws in the 3 locations.

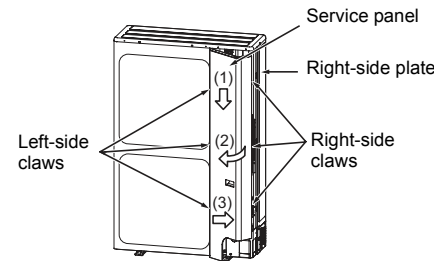

■ Knockout of Pipe Cover

Knockout procedure

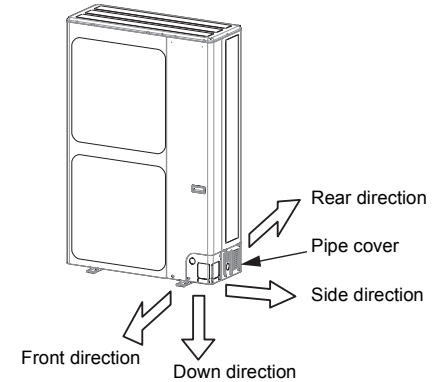

- The indoor/outdoor connecting pipes can be connected in 4 directions. Take off the knockout part of the pipe cover through which pipes or wires will pass through the base plate.
- Detach the pipe cover and tap on the knockout section a few times with the shank of a screwdriver. A knockout hole can easily be punched.
- After punching out the knockout hole, remove burrs from the hole and then install the supplied protective bush and guard material around the passage hole to protect wires and pipes. Be sure to attach the pipe covers after pipes have been connected. Cut the slits under the pipe covers to facilitate the installation. After connecting the pipes, be sure to mount the pipe cover. The pipe cover is easily mounted by cutting off the slit at the lower part of the pipe cover.

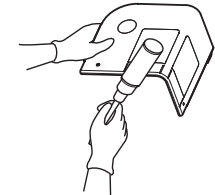

* Be sure to wear heavy work gloves while working.

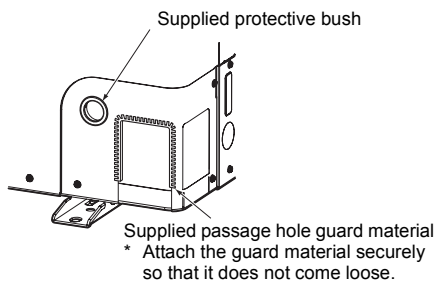

■ Optional Installation Parts (Locally procured)

	Parts name	Q'ty
A	Refrigerant piping Liquid side: Ø9.5 mm Gas side: Ø15.9 mm	One each
B	Pipe insulating material (polyethylene foam, 10 mm thick)	1
C	Putty, PVC tape	One each

■ Refrigerant Piping Connection

⚠ CAUTION

Take note of these 4 important points below for piping work

1. Keep dust and moisture away from inside the connecting pipes.
2. Tightly connect the connection between pipes and the unit.
3. Evacuate the air in the connecting pipes using a VACUUM PUMP.
4. Check for gas leaks at connection points.

Piping connection

Liquid side	
Outer diameter	Thickness
9.5 mm	0.8 mm
Gas side	
Outer diameter	Thickness
15.9 mm	1.0 mm

Flaring

1. Cut the pipe with a pipe cutter.
Be sure to remove burrs that may cause a gas leak.
2. Insert a flare nut into the pipe, and then flare the pipe.
Use the flare nuts supplied with the air conditioner or those for R32.
Insert a flare nut into the pipe, and flare the pipe.
Use the flare nuts supplied with the air conditioner or flare nuts for R32 or R410A.
However, the conventional tools can be used by adjusting the projection margin of the copper pipe.

Projection margin in flaring: B (Unit: mm)

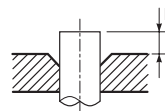

Rigid (Clutch type)

Outer dia. of copper pipe	R32 or R410A tool used	Conventional tool used
9.5	0 to 0.5	1.0 to 1.5
15.9		

Flaring diameter size: A (Unit: mm)



Outer dia. of copper pipe	A ⁺⁰ _{-0.4}
9.5	13.2
15.9	19.7

⚠ CAUTION

- Do not scratch the inner surface of the flared part when removing burrs.
- Flare processing under the condition of scratches on the inner surface of flare processing part will cause refrigerant gas leak.
- Check that the flared part is not scratched, deformed, stepped, or flattened, and that there are no chips adhered or other problems, after flare processing.
- Do not apply refrigerating machine oil to the flare surface.

■ Tightening of Connecting Part

1. Align the centers of the connecting pipes and fully tighten the flare nut with your fingers. Then fix the nut with a wrench as shown in the figure and tighten it with a torque wrench.
2. As shown in the figure, be sure to use two wrenches to loosen or tighten the flare nut of the valve on the gas side. If you use a single crescent, the flare nut cannot be tightened to the required tightening torque. On the other hand, use a single crescent to loosen or tighten the flare nut of the valve on the liquid side.

(Unit: N·m)

Outer dia. of copper pipe	Tightening torque
9.5 mm	33 to 42
15.9 mm	68 to 82

Valve at gas side

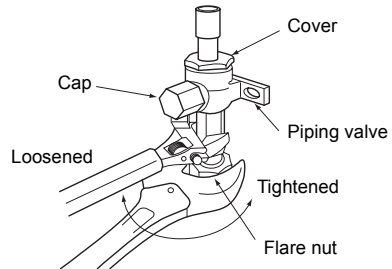

⚠ CAUTION

- Do not put the crescent wrench on the cap or cover. The valve may break.
- If applying excessive torque, the nut may break according to some installation conditions.

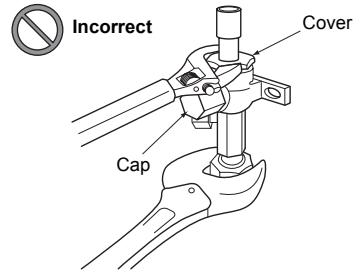

- After the installation work, be sure to check for gas leaks of the pipe connections with nitrogen.
- Therefore, using a torque wrench, tighten the flare pipe connecting sections that connect the indoor/outdoor units at the specified tightening torque. Incomplete connections may cause not only a gas leak, but also trouble with the refrigeration cycle.

Do not apply refrigerating machine oil to the flared surface.

■ Refrigerant Pipe Length

Single

Allowable pipe length (m)	Height difference (Indoor-outdoor H) (m)	
	Indoor unit: Upper	Outdoor unit: Lower
Total length L	75	30

Pipe diameter (mm)		Number of bent portions
Gas side	Liquid side	
Ø15.9	Ø9.5	10 or less

Simultaneous twin, triple

System	Model	Allowable pipe length (m)			Height difference (m)		
		Total length • $l_1 + l_2$ • $l_1 + l_3$ • $l_1 + l_4$ Maximum	Distributed pipes • l_2 • l_3 • l_4 Maximum	Distributed pipes • $l_3 - l_2$ • $l_4 - l_2$ • $l_4 - l_3$ Maximum	Indoor-outdoor H		Indoor-indoor (Δh)
				Indoor unit: Upper	Outdoor unit: Upper		
TWIN	GP110	50	15	10	30	30	0.5
	GP140, GP160	50	15	10	30	30	0.5
TRIPLE	GP160 only	50	15	10	30	30	0.5

System	Model	Pipe diameter (mm)				Number of bent portions
		Main pipe		Branching pipe		
		Gas side	Liquid side	Gas side	Liquid side	
TWIN	GP110	Ø15.9	Ø9.5	Ø12.7	Ø6.4	10 or less
	GP140, GP160	Ø15.9	Ø9.5	Ø15.9	Ø9.5	10 or less
TRIPLE	GP160 only	Ø15.9	Ø9.5	Ø12.7	Ø6.4	10 or less

Figure of Single

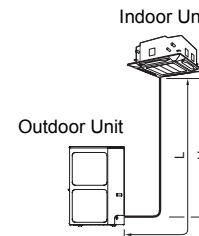

Figure of Simultaneous twin

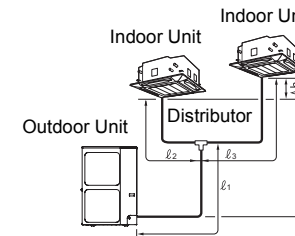
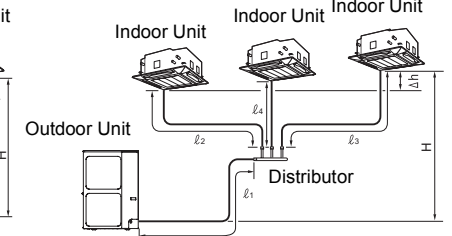

Figure of Simultaneous triple



6 AIR PURGING

■ Airtight Test

After completing the refrigerant piping work, perform an airtight test. Connect a nitrogen gas cylinder and pressurize the pipes with nitrogen gas as follows to conduct the airtight test.

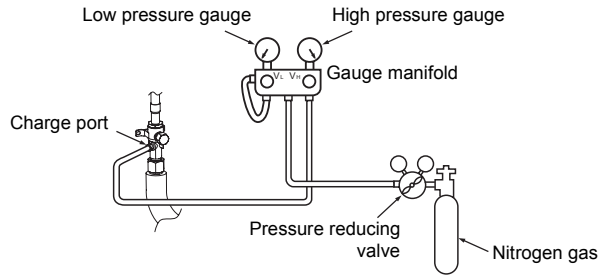

CAUTION
Never use oxygen, flammable gas, or noxious gas for the airtight test.

Gas leak check

- Step 1 ... Pressurize to **0.5 MPa** (5 kg/cm²G) for 5 minutes or longer. > Major leaks can be discovered.
 - Step 2 ... Pressurize to **1.5 MPa** (15 kg/cm²G) for 5 minutes or longer. > Micro leaks can be discovered.
 - Step 3 ... Pressurize to **4.15 MPa** (42 kg/cm²G) for 24 hours. Micro leaks can be discovered.
- (However, note that when the ambient temperature differs during pressurization and after 24 hours, the pressure will change by approximately 0.01 MPa (0.1 kg/cm²G) per 1°C, so this should be compensated.)

If the pressure drops in steps 1 through 3, check the connections for leakage. Check for leaks with foaming liquid, etc., take steps to fix the leaks such as brazing the pipes again and tightening the flare nuts, and then perform the airtight test again.

* After the airtight test is completed, evacuate the nitrogen gas.

■ Air Purge

With respect to the preservation of the terrestrial environment, adopt "Vacuum pump" to purge air (Evacuate air in the connecting pipes) when installing the unit.

- Do not discharge the refrigerant gas to the atmosphere to preserve the terrestrial environment.
- Use a vacuum pump to discharge the air (nitrogen, etc.) that remains in the set. If air remains, the capacity may decrease.

For the vacuum pump, be sure to use one with a backflow preventer so that the oil in the pump does not backflow into the pipe of the air conditioner when the pump stops.

(If oil in the vacuum pump is put in an air conditioner including R32, it may cause trouble with the refrigeration cycle.)

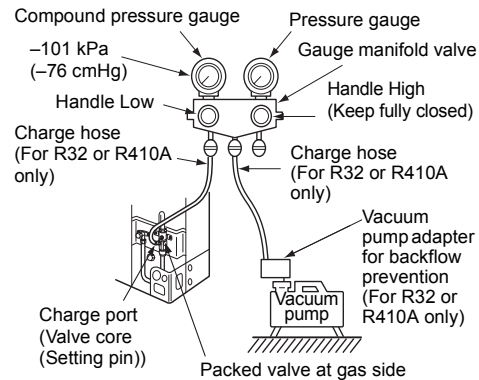

Vacuum pump

- As shown in the figure, connect the charge hose after the manifold valve is closed completely.
- ↓
- Attach the connecting port of the charge hose with a projection to push the valve core (setting pin) to the charge port of the set.
- ↓
- Open Handle Low fully.
- ↓
- Turn ON the vacuum pump. (*1)
- ↓
- Loosen the flare nut of the packed valve (Gas side) a little to check that the air passes through. (*2)
- ↓
- Retighten the flare nut.
- ↓
- Execute vacuuming until the compound pressure gauge indicates -101 kPa (-76 cmHg). (*1)
- ↓
- Close Handle Low completely.
- ↓
- Turn OFF the vacuum pump.
- ↓
- Leave the vacuum pump as it is for 1 or 2 minutes, and check that the indicator of the compound pressure gauge does not return.
- ↓
- Open the valve stem or valve handle fully. (First, at liquid side, then gas side)
- ↓
- Disconnect the charge hose from the charge port.
- ↓
- Tighten the valve and caps of the charge port securely.

- *1 Use the vacuum pump, vacuum pump adapter, and gauge manifold correctly referring to the manuals supplied with each tool before using them. Check that the vacuum pump oil is filled up to the specified line of the oil gauge.
- *2 When air is not charged, check again whether the connecting port of the discharge hose, which has a projection to push the valve core, is firmly connected to the charge port.

■ How to Open the Valve

Fully open the valves of the outdoor unit. (First fully open the valve on the liquid side, and then fully open the valve on the gas side.)

- * Do not open or close the valves when the ambient temperature is -20°C or less. Doing so may damage the valve O-rings and result in refrigerant leakage.

Liquid side

Open the valve with hexagon wrench.

Hexagon wrench size
4 mm

Gas side

Ball valve

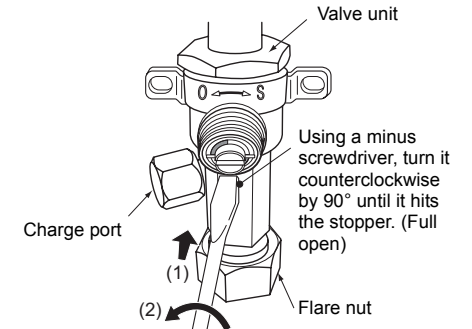

Groove position

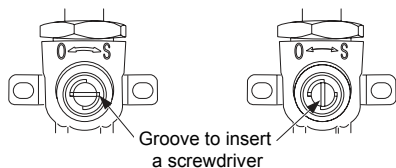

Closed completely

Opened fully

- While the valve is fully opened, after the screwdriver has reached the stopper, do not apply torque exceeding 5 N·m. Applying excessive torque may damage the valve.

Valve handling precautions

- Open the valve stem until it strikes the stopper. It is unnecessary to apply further force.
- Securely tighten the cap with a torque wrench.

Cap tightening torque

Cap tightening torque		Valve type	
Valve size	Ø9.5 (H22)*	33 to 42 N·m (3.3 to 4.2 kgf·m)	Service valve
	Ø9.5 (H19)*	14 to 18 N·m (1.4 to 1.8 kgf·m)	Service valve
	Ø15.9	20 to 25 N·m (2.0 to 2.5 kgf·m)	Ball valve
Charge port	14 to 18 N·m (1.4 to 1.8 kgf·m)	Ball valve	



* The H dimension is the width across flats of the cap.

■ Replenishing Refrigerant

This model is a 30 m chargeless type that does not need to have its refrigerant replenished for refrigerant pipes up to 30 m. When a refrigerant pipe longer than 30 m is used, add the specified amount of refrigerant.

Refrigerant replenishing procedure

- After vacuuming the refrigerant pipe, close the valves and then charge the refrigerant while the air conditioner is not working.
- When the refrigerant cannot be charged to the specified amount, charge the required amount of refrigerant from the charge port of the valve on the gas side during cooling.

Requirement for replenishing refrigerant

Replenish liquid refrigerant.

When gaseous refrigerant is replenished, the refrigerant composition varies, which disables normal operation.

Charging additional refrigerant

Figure of Single

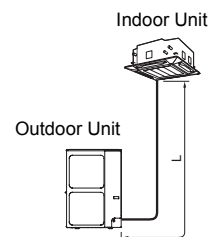

Figure of Simultaneous twin

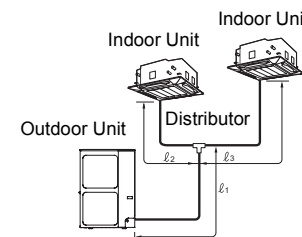
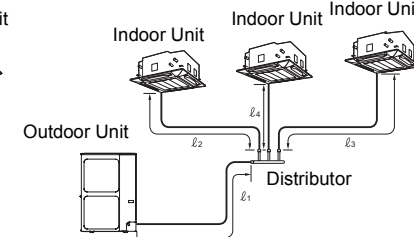

Figure of Simultaneous triple



Formula for calculating the amount of additional refrigerant

(Formula will differ depending on the diameter of the liquid connecting side pipe.)

* l_1 to l_4 are the lengths of the pipes shown in the figures above (unit: m).

Single

Diameter of connecting pipe (liquid side)	Amount of additional refrigerant per meter (g/m)	Amount of additional refrigerant (g) = Amount of refrigerant charged for main pipe
l	α	$\alpha \times (l - 30)$
Ø9.5	40	

Simultaneous twin

Outdoor unit	Diameter of connecting pipe (liquid side)			Amount of additional refrigerant per meter (g/m)		Amount of additional refrigerant (g) = Amount of refrigerant charged for main pipe + amount of refrigerant charged for branch piping
	l_1	l_2	l_3	α	β	
GP110	Ø9.5	Ø6.4	Ø6.4	40	20	$\alpha \times (l_1 - 28) + \beta \times (l_2 + l_3 - 4)$
GP140 GP160	Ø9.5	Ø9.5	Ø9.5	40	40	

Simultaneous triple

Outdoor unit	Diameter of connecting pipe (liquid side)				Amount of additional refrigerant per meter (g/m)		Amount of additional refrigerant (g) = Amount of refrigerant charged for main pipe + amount of refrigerant charged for branch piping
	l_1	l_2	l_3	l_4	α	β	
GP160	Ø9.5	Ø6.4	Ø6.4	Ø6.4	40	20	$\alpha \times (l_1 - 28) + \beta \times (l_2 + l_3 + l_4 - 6)$

Gas leak inspection

Use a leak detector manufactured specially for HFC refrigerant (R32, R410A, R134a, etc.) to perform the R32 gas leak inspection.

- * Leak detectors for conventional HCFC refrigerant (R22, etc.) cannot be used, as the sensitivity drops to approximately 1/40 when used for HFC refrigerant.
- R32 has a high working pressure, so failure to perform the installation work properly may result in gas leaks such as when the pressure rises during operation. Be sure to perform leak tests on the piping connections.

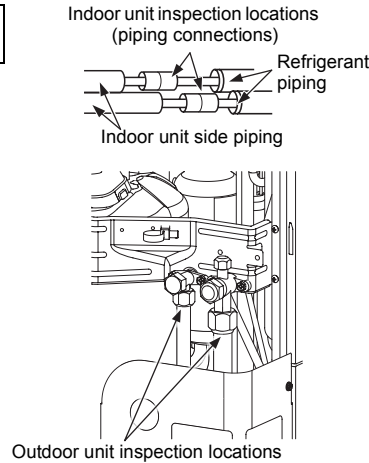

Insulating the Pipes

- The temperatures at both the liquid side and gas side will be low during cooling so in order to prevent condensation, be sure to insulate the pipes at both of these sides.
- Insulate the pipes separately for the liquid side and gas side.
- Insulate the branch pipes by following the instructions in the installation manual provided with the branch pipe kit.

REQUIREMENT

Be sure to use an insulating material which can withstand temperatures above 120°C for the gas side pipe since this pipe will become very hot during heating operations.

To Fix the Fluorinated Greenhouse Gases Label

This product contains fluorinated greenhouse gases. Do not vent gases into the atmosphere.

Contains fluorinated greenhouse gases	
• Chemical Name of Gas	R32
• Global Warming Potential (GWP) of Gas	675

CAUTION

- Stick the enclosed refrigerant label adjacent to the service ports for charging or recovering location and where possible adjacent to existing nameplates or product information label.
- Clearly write the charged refrigerant quantity on the refrigerant label using indelible ink. Then, place the included transparent protective sheet over the label to prevent the writing from rubbing off.
- Prevent emission of the contained fluorinated greenhouse gas. Ensure that the fluorinated greenhouse gas is never vented to the atmosphere during installation, service or disposal. When any leakage of the contained fluorinated greenhouse gas is detected, the leak shall be stopped and repaired as soon as possible.
- Only qualified service personnel are allowed to access and service this product.
- Any handling of the fluorinated greenhouse gas in this product, such as when moving the product or recharging the gas, shall comply under (EU) Regulation No.517/2014 on certain fluorinated greenhouse gases and any relevant local legislation.
- Periodical inspections for refrigerant leaks may be required depending on European or local legislation.
- Contact dealers, installers, etc., for any questions.

Fill in the label as follows:

Refrigerant Label

Contains fluorinated greenhouse gases.

① Pre-charged refrigerant at factory [kg], specified in the nameplate.

② Additional charge on installation site [kg].

③ Total quantity of refrigerant in tonnes CO₂ equivalent.

Caution: Write out charge amount ①, ②, ①+② and ③ by indelible means on installation site.

R32 GWP:675

① = kg ← Pre-charged refrigerant at factory [kg], specified in the nameplate

② = kg ← Additional charge on installation site [kg]

①+② = kg

③ = t ← $\frac{\text{GWP} \times \text{kg}}{1000}$

DG44206103

7 ELECTRICAL WORK

⚠ WARNING

1. **Using the specified wires, ensure that the wires are connected, and fix wires securely so that the external tension to the wires does not affect the connecting part of the terminals.**
Incomplete connection or fixation may cause a fire, etc.
2. **Be sure to connect the earth wire. (Grounding work)**
Incomplete earthing may lead to electric shock. Do not connect earth wires to gas pipes, water pipes, lightning rods or earth wires for telephone wires.
3. **The appliance shall be installed in accordance with national wiring regulations.**
Capacity shortages of the power circuit or an incomplete installation may cause an electric shock or fire.

⚠ CAUTION

- An installation fuse must be used for the power supply line of this air conditioner.
- Incorrect / incomplete wiring may lead to an electrical fire or smoke.
- Prepare an exclusive power supply for the air conditioner.
- This product can be connected to the mains power.
Fixed wire connections:
A switch that disconnects all poles and has a contact separation of at least 3 mm must be incorporated in the fixed wiring.
- Be sure to use the cord clamps attached to the product.
- Do not damage or scratch the conductive core or inner insulator of the power and indoor/outdoor connecting wires when peeling them.
- Use the power and indoor/outdoor connecting wires with specified thicknesses, specified types and protective devices required.

- Remove the service panel, and the terminal cover.
- A conduit pipe can be installed through the hole for wiring. If the hole size does not fit the wiring pipe to be used, drill the hole again to an appropriate size.
- Be sure to clamp the power wires and indoor/outdoor connecting wires with a cord clamp along the connecting pipe so that the wires do not touch the compressor or discharge pipe.
(The compressor and the discharge pipe become hot.)

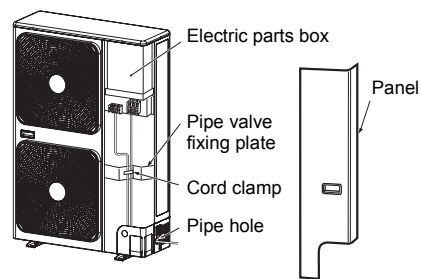

■ Wiring between Indoor Unit and Outdoor Unit

The dashed lines show on-site wiring.

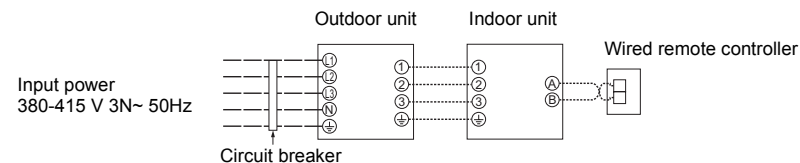

- Connect the indoor/outdoor connecting wires to the identical terminal numbers on the terminal block of each unit. Incorrect connection may cause a failure.

For the air conditioner, connect a power wire with the following specifications.

■ Power and Wiring Specifications

Model (RAV-GP Type)	110AT8	140AT8	160AT8
Power supply	380-415 V 3N~ 50 Hz		
Maximum running current	16.4 A		
Recommended field fuse	20 A		
Power wire*	5 × 2.5 mm ² or more (H07 RN-F or 60245 IEC 66)		
Indoor/outdoor connecting wires*	4 × 1.5 mm ² or more (H07 RN-F or 60245 IEC 66)		

* Number of wire × wire size

How to wire

1. Connect the connecting wire to the terminal as identified with their respective numbers on the terminal block of the indoor and outdoor units.
H07 RN-F or 60245 IEC 66 (1.5 mm² or more)
2. When connecting the connecting wire to the outdoor unit terminal, prevent water from coming into the outdoor unit.
3. Secure the power supply wire and indoor/outdoor connecting wires using the cord clamp of the outdoor unit.
4. For interconnecting wires, do not use a wire joined to another on the way.
Use wires long enough to cover the entire length.
5. **Wiring connections differ in conformance to EMC standards, depending whether the system is single, twin or triple. Connect wires according to respective instructions.**

CAUTION

- Fuse must be used in installation for the power supply line of this air conditioner.
- Incorrect/incomplete wiring may lead to an electrical fire or smoke.
- Prepare an exclusive power supply for the air conditioner.
- This product can be connected to the mains power.
Fixed wire connections:
A switch that disconnects all poles and has a contact separation of at least 3 mm must be incorporated in the fixed wiring.

Wiring diagram

* For details on the remote controller wiring/installation, refer to the Installation Manual enclosed with the remote controller.

Single system

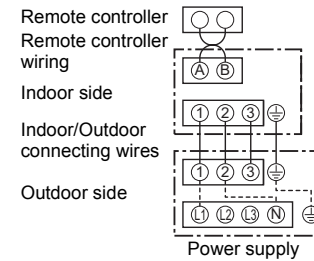

Simultaneous twin system

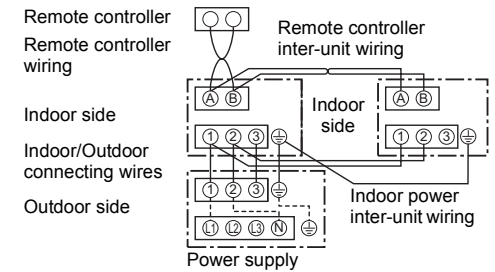

Simultaneous triple system (GP160 only)

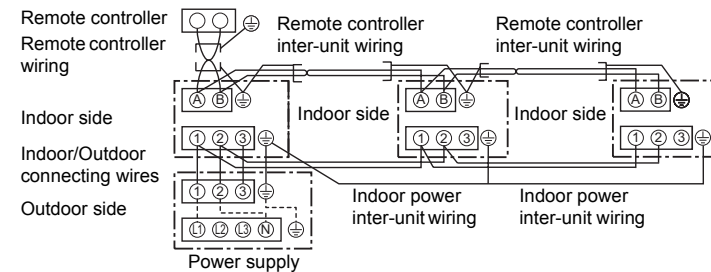

* Use 2-core shield wire (MVVS 0.5 to 2.0 mm² or more) for the remote controller wiring in the simultaneous twin and simultaneous triple systems to prevent noise problems. Be sure to connect both ends of the shield wire to earth leads.

* Connect earth wires for each indoor unit in the simultaneous twin and simultaneous triple systems.

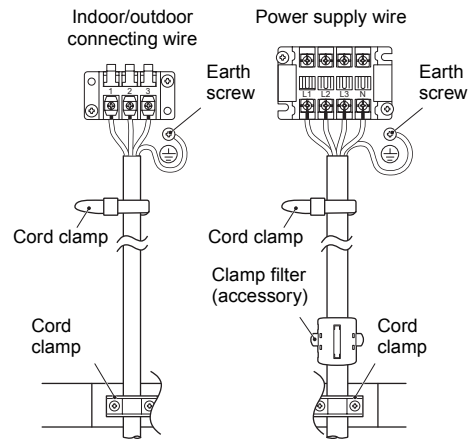

Stripping length power cord and connecting wire

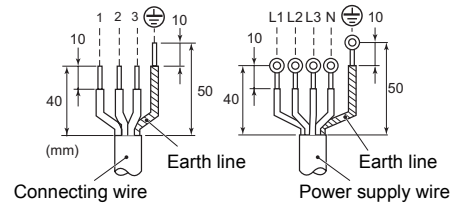

8 EARTHING

⚠ WARNING

Be sure to connect the earth wire. (Grounding work)
Incomplete earthing may cause an electric shock.

Connect the earth line properly following applicable technical standards. Connecting the earth line is essential to preventing electric shock and to reducing noise and electrical charges on the outdoor unit surface due to the high-frequency wave generated by the frequency converter (inverter) in the outdoor unit. If you touch the charged outdoor unit without an earth line, you may experience an electric shock.

9 FINISHING

After the refrigerant pipe, inter-unit wires, and drain pipe have been connected, cover them with finishing tape and clamp them to the wall with off-the-shelf support brackets or their equivalent. Keep the power wires and indoor/outdoor connecting wires off the valve on the gas side or pipes that have no heat insulator.

10 TEST RUN

- **Turn on the circuit breaker at least 12 hours before starting a test run to protect the compressor during startup.**
To protect the compressor, power is supplied from the 380-415 VAC input to the unit to preheat the compressor.
- **Check the following before starting a test run:**
 - **That all pipes are connected securely without leaks.**
 - **That the valve is open.**

If the compressor is operated with the valve closed, the outdoor unit will become overpressurized, which may damage the compressor or other components.
If there is a leak at a connection, air can be sucked in and the internal pressure further increases, which may cause a burst or injury.
- Operate the air conditioner in the correct procedure as specified in the Owner's Manual.

11 ANNUAL MAINTENANCE

For an air conditioning system that is operated on a regular basis, cleaning and maintenance of the indoor/outdoor units are strongly recommended.

As a general rule, if an indoor unit is operated for about 8 hours daily, the indoor/outdoor units will need to be cleaned at least once every 3 months. This cleaning and maintenance should be carried out by a qualified service person.

Failure to clean the indoor/outdoor units regularly will result in poor performance, icing, water leaking and even compressor failure.

12 AIR CONDITIONER OPERATING CONDITIONS

For proper performance, operate the air conditioner under the following temperature conditions:

Cooling operation	Dry bulb temp.	-15 °C to 46 °C
Heating operation	Wet bulb temp.	-20 °C to 15 °C

If air conditioner is used outside of the above conditions, safety protection may work.

13 FUNCTIONS TO BE IMPLEMENTED LOCALLY

■ Handling Existing Pipe (Refer to 15 APPENDIX)

When using the existing pipe, carefully check for the following:

- Wall thickness (within the specified range)
- Scratches and dents
- Water, oil, dirt, or dust in the pipe
- Flare looseness and leakage from welds
- Deterioration of copper pipe and heat insulator

Cautions for using existing pipe

- Do not reuse a flare nut to prevent gas leaks.
Replace it with the supplied flare nut and then process it to a flare.
- Blow nitrogen gas or use an appropriate means to keep the inside of the pipe clean. If discolored oil or much residue is discharged, wash the pipe.
- Check welds, if any, on the pipe for gas leaks.



When the pipe corresponds to any of the following, do not use it. Install a new pipe instead.

- The pipe has been opened (disconnected from indoor unit or outdoor unit) for a long period.
- The pipe has been connected to an outdoor unit that does not use refrigerant R22, R410A or R407C.

- The existing pipe must have a wall thickness equal to or larger than the following thicknesses.

Reference outside diameter (mm)	Wall thickness (mm)	Material
6.4	0.8	-
9.5	0.8	-
12.7	0.8	-
15.9	1.0	-

- Do not use any pipe with a wall thickness less than these thicknesses due to insufficient pressure capacity.
- When using a Ø19.1 mm gas pipe for the existing piping, set bit 3 of SW802 (switch for existing pipe) on the P.C. board of the outdoor unit to ON. In this case, the heating performance may be reduced depending on the outside air temperature and room temperature.

SW802	
When shipped from factory	When using existing pipe
	

■ Refrigerant recovery

- Use refrigerant recovery switch SW801 on the P.C. board of the outdoor unit to recover refrigerant when the indoor or outdoor unit is moved.
- Before recovering the refrigerant in the existing system, perform a cooling operation for at least 30 minutes.

Procedure

1. Turn on the power of the air conditioner.
2. Select the FAN mode for indoor unit operation with the remote controller.
3. Set SW804 on the P.C. board of the outdoor unit to all OFF, and then press SW801 for 1 second or more. The air conditioner enters the forced cooling mode for up to 10 minutes. Operate or handle the valve to recover refrigerant during this time period.
4. Upon completion of refrigerant recovery, close the valve and press SW801 for at least 1 second to stop operation.
5. Turn off the power.

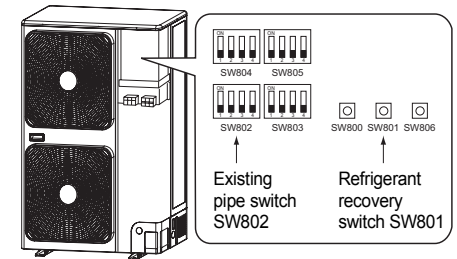

DANGER

Be careful of electric shock because the P.C. board has an electrical current running through it.

14 TROUBLESHOOTING

You can perform fault diagnosis of the outdoor unit with the LEDs on the P.C. board of the outdoor unit in addition to using the check codes displayed on the wired remote controller of the indoor unit.

Use the LEDs and check codes for various checks. Details of the check codes displayed on the wired remote controller of the indoor unit are described in the Installation Manual of the indoor unit.

Verifying current abnormal status

1. Check that DIP switch SW803 is set to OFF.
2. Jot down the states of LED800 to LED804. (Display mode 1)
3. Press SW800 for at least 1 second. The LED status changes to display mode 2.
4. Check the code whose display mode 1 equals the LED states jotted down and display mode 2 equals the current flashing status of LED800 to LED804 from the following table to identify the cause.

Verifying an abnormal state in the past although the abnormal state no longer occurs

1. Set bit 1 of DIP switch SW803 to ON.
2. Jot down the states of LED800 to LED804. (Display mode 1)
3. Press SW800 for at least 1 second. The LED status changes to display mode 2.
4. Find an error whose display mode 1 equals the LED states jotted down and display mode 2 equals the current flashing states of LED800 to LED804 from the following table to identify the error.
 - An outside **air temperature (TO) sensor error** can be checked only while it occurs.

15 APPENDIX

[1] Existing piping

Work instructions

The existing R22 and R407C piping can be reused for our digital inverter R32 product installations.

WARNING

Confirming the existence of scratches or dents on the existing pipes and confirming the reliability of the pipe strength are conventionally referred to the local site.

If the specified conditions can be cleared, it is possible to update existing R22 and R407C pipes to those for R32 models.

Basic conditions needed to reuse existing pipes

Check and observe the presence of three conditions in the refrigerant piping works.

1. **Dry** (There is no moisture inside of the pipes.)
2. **Clean** (There is no dust inside of the pipes.)
3. **Tight** (There are no refrigerant leaks.)

Restrictions for use of existing pipes

In the following cases, the existing pipes should not be reused as they are. Clean the existing pipes or exchange them with new pipes.

1. When a scratch or dent is heavy, be sure to use new pipes for the refrigerant piping works.
2. When the existing pipe thickness is thinner than the specified "Pipe diameter and thickness," be sure to use new pipes for the refrigerant piping works.
 - The operating pressure of R32 is high. If there is a scratch or dent on the pipe or a thinner pipe is used, the pressure strength may be inadequate, which may cause the pipe to break in the worst case.

* Pipe diameter and thickness (mm)

Reference outside diameter (mm)	Wall thickness (mm)	Material
6.4	0.8	—
9.5	0.8	—
12.7	0.8	—
15.9	1.0	—

- In case the pipe diameter is $\varnothing 12.7$ mm or less and the thickness is less than 0.7 mm, be sure to use new pipes for the refrigerant piping works.
3. When the outdoor unit was left with the pipes disconnected, or the gas leaked from the pipes and the pipes were not repaired and refilled.
 - There is the possibility of rain water or air, including moisture, entering the pipe.
 4. When refrigerant cannot be recovered using a refrigerant recovery unit.
 - There is the possibility that a large quantity of dirty oil or moisture remains inside the pipes.
 5. When a commercially available dryer is attached to the existing pipes.
 - There is the possibility that copper green rust has been generated.
 6. When the existing air conditioner is removed after refrigerant has been recovered.

Check if the oil is judged to be clearly different from normal oil.

 - The refrigerator oil is copper rust green in color: There is the possibility that moisture has mixed with the oil and rust has been generated inside the pipe.
 - There is discolored oil, a large quantity of residue, or a bad smell.
 - A large quantity of shiny metal dust or other wear residue can be seen in the refrigerant oil.
 7. When the air conditioner has a history of the compressor failing and being replaced.
 - When discolored oil, a large quantity of residue, shiny metal dust, or other wear residue or mixture of foreign matter is observed, trouble will occur.

8. When temporary installation and removal of the air conditioner are repeated such as when leased, etc.
9. If the type of refrigerator oil of the existing air conditioner is other than the following oil (Mineral oil), Suniso, Freol-S, MS (Synthetic oil), alkyl benzene (HAB, Barrel-freeze), ester series, PVE only of ether series.
 - The winding-insulation of the compressor may deteriorate.

NOTE

The above descriptions are results have been confirmed by our company and represent our views on our air conditioners, but do not guarantee the use of the existing pipes of air conditioners that have adopted R32 or R410A in other companies.

Branching pipe for simultaneous operation system

In the concurrent twin system, when TOSHIBA has specified that branching pipe is to be used, it can be reused.

Branching pipe model name:

RBC-TWP30E, RBC-TWP50E, RBC-TRP100E

On the existing air conditioner for simultaneous operation system (twin, triple system), there are cases of branch pipes being used that have insufficient compressive strength.

In such case, please change the piping to a branch pipe for R32 or R410A.

Curing of pipes

When removing and opening the indoor or outdoor unit for a long time, cure the pipes as follows:

- Otherwise rust may be generated when moisture or foreign matter due to condensation enters the pipes.
- The rust cannot be removed by cleaning, and new pipes are necessary.

Placement location	Term	Curing manner
Outdoors	1 month or more	Pinching
	Less than 1 month	Pinching or taping
Indoors	Every time	

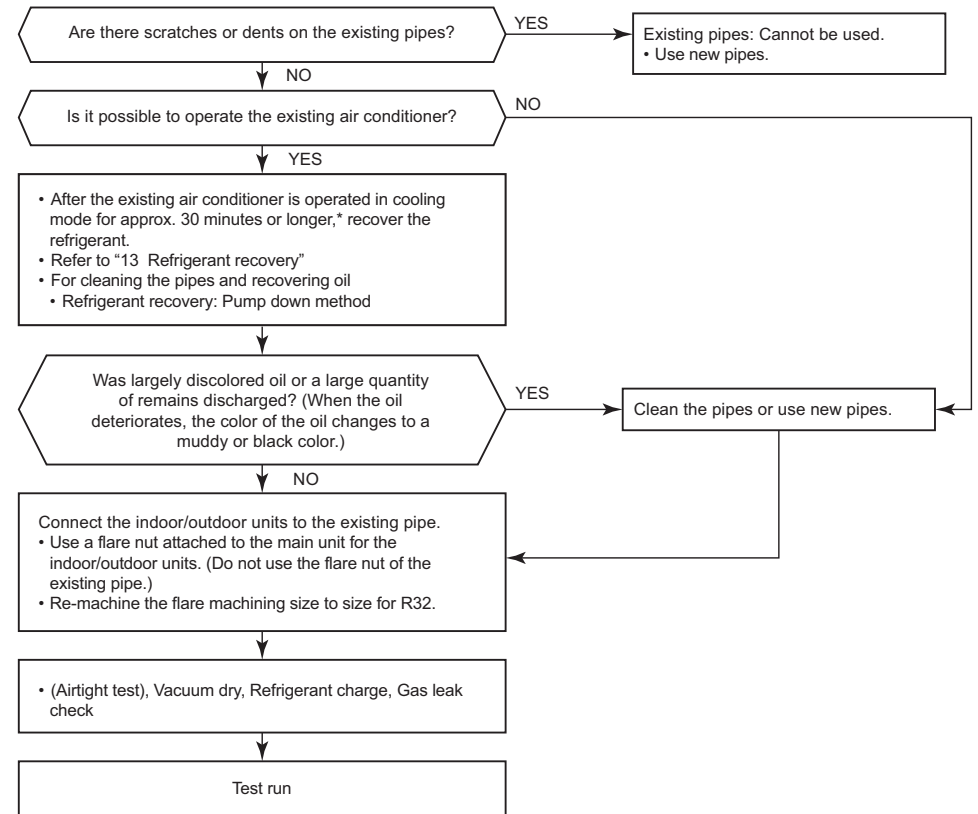

[2] Minimum floor area: A_{min} (m²)

Piping length (m)	Total refrigerant quantity*	Floor standing unit	Wall mounted unit	Ceiling mounted unit
	h_0	0.6	1.8	2.2
	M (kg)	A_{min} (m ²)		
~30	2.6	58.00	6.44	4.31
31	2.64	59.80	6.64	4.45
32	2.68	61.63	6.85	4.58
33	2.72	63.48	7.05	4.72
34	2.76	65.36	7.26	4.86
35	2.8	67.27	7.47	5.00
36	2.84	69.21	7.69	5.15
37	2.88	71.17	7.91	5.29
38	2.92	73.16	8.13	5.44
39	2.96	75.18	8.35	5.59
40	3	77.22	8.58	5.74
41	3.04	79.30	8.81	5.90
42	3.08	81.40	9.04	6.05
43	3.12	83.53	9.28	6.21
44	3.16	85.68	9.52	6.37
45	3.2	87.86	9.76	6.54
46	3.24	90.07	10.01	6.70
47	3.28	92.31	10.26	6.87
48	3.32	94.58	10.51	7.03
49	3.36	96.87	10.76	7.21
50	3.4	99.19	11.02	7.38
51	3.44	101.54	11.28	7.55
52	3.48	103.91	11.55	7.73
53	3.52	106.32	11.81	7.91
54	3.56	108.75	12.08	8.09
55	3.6	111.20	12.36	8.27
56	3.64	113.69	12.63	8.46
57	3.68	116.20	12.91	8.64
58	3.72	118.74	13.19	8.83
59	3.76	121.31	13.48	9.02
60	3.8	123.90	13.77	9.22
61	3.84	126.53	14.06	9.41
62	3.88	129.17	14.35	9.61
63	3.92	131.85	14.65	9.81
64	3.96	134.56	14.95	10.01
65	4	137.29	15.25	10.21
66	4.04	140.05	15.56	10.42
67	4.08	142.83	15.87	10.62
68	4.12	145.65	16.18	10.83
69	4.16	148.49	16.50	11.04
70	4.2	151.36	16.82	11.26
71	4.24	154.26	17.14	11.47
72	4.28	157.18	17.46	11.69
73	4.32	160.13	17.79	11.91
74	4.36	163.11	18.12	12.13
75	4.4	166.12	18.46	12.36

* Total refrigerant quantity: Refrigerant quantity pre-charged at factory + Additional refrigerant quantity charged during installation

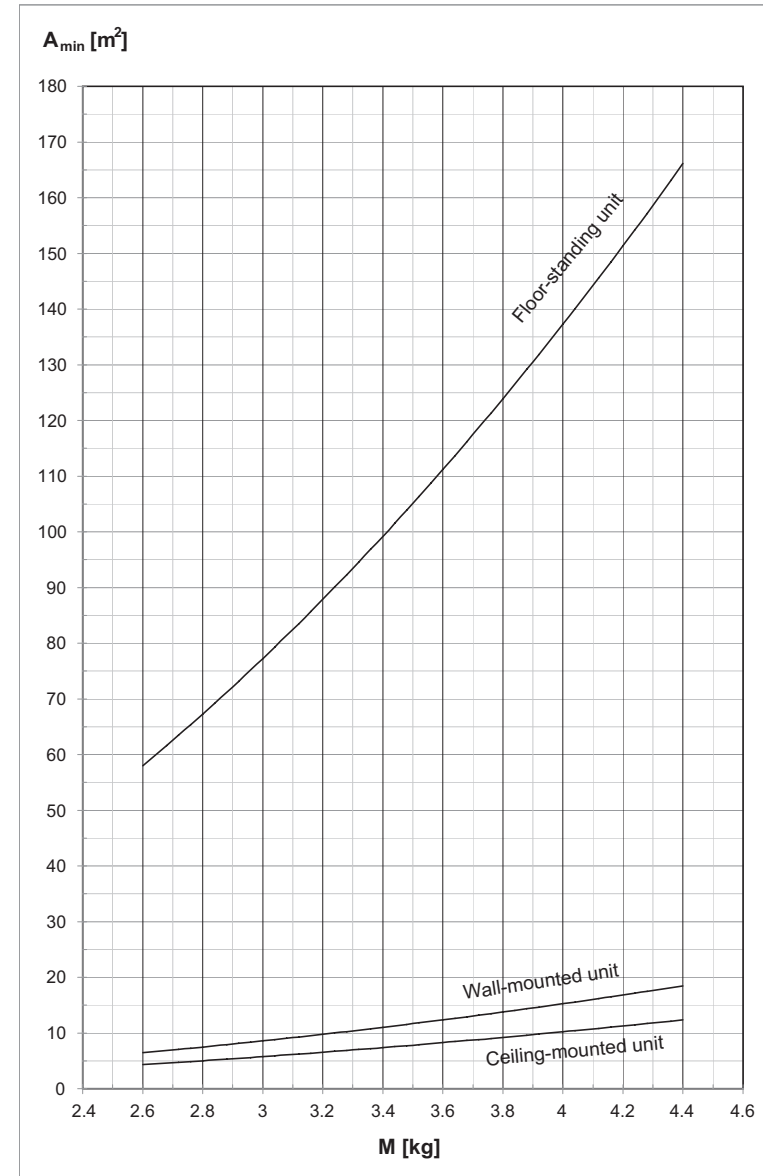

16 SPECIFICATIONS

Model	Sound pressure level (dB(A))		Weight (kg)
	Cooling	Heating	
RAV-GP1101AT8-E	*	*	95
RAV-GP1101AT8J-E	*	*	95
RAV-GP1401AT8-E	*	*	95
RAV-GP1401AT8J-E	*	*	95
RAV-GP1601AT8-E	*	*	95
RAV-GP1601AT8J-E	*	*	95

* Under 70 dB(A)

Product information of ecodesign requirements. (Regulation (EU) 2016/2281)

<http://ecodesign.toshiba-airconditioning.eu/en>

Declaration of Conformity

Manufacturer: TOSHIBA CARRIER CORPORATION
336 Tadehara, Fuji-shi, Shizuoka-ken 416-8521 JAPAN

TCF holder: TOSHIBA CARRIER EUROPE S.A.S
Route de Thil
01120 Montluel FRANCE

Hereby declares that the machinery described below:

Generic Denomination: Air Conditioner

Model/type: RAV-GP1101AT8-E, RAV-GP1401AT8-E, RAV-GP1601AT8-E
RAV-GP1101AT8J-E, RAV-GP1401AT8J-E, RAV-GP1601AT8J-E

Commercial name: Super Digital Inverter Series Air Conditioner

Complies with the provisions of the "Machinery Directive" (Directive 2006/42/EC) and the regulations transposing into national law

Complies with the provisions of the following harmonized standard: EN 378-2

Note: This declaration becomes invalid if technical or operational modifications are introduced without the manufacturer's consent.

Warnings on Refrigerant Leakage

Check of concentration limit

The room in which the air conditioner is to be installed requires a design that in the event of refrigerant gas leaking out, its concentration will not exceed a set limit.

The refrigerant R32 which is used in the air conditioner is safe, without the toxicity or combustibility of ammonia, and is not restricted by laws to be imposed which protect the ozone layer. However, since it contains more than air, it poses the risk of suffocation if its concentration should rise excessively. Suffocation from leakage of R32 is almost non-existent.

If a conditioner system is to be installed in a small room, select a suitable model and installation procedure so that if the refrigerant accidentally leaks out, its concentration does not reach the limit (and in the event of an emergency, measures can be made before injury can occur).

In a room where the concentration may exceed the limit, create an opening with adjacent rooms, or install mechanical ventilation combined with a gas leak detection device.

The concentration is as given below.

$$\frac{\text{Total amount of refrigerant (kg)}}{\text{Min. volume of the indoor unit installed room (m}^3\text{)}} \leq \text{Concentration limit (kg/m}^3\text{)}$$

Refrigerant Concentration Limit shall be in accordance with local regulations.

.....
.....
.....
.....
.....
.....
.....
.....
.....
.....
.....
.....
.....
.....
.....
.....
.....
.....
.....
.....
.....
.....
.....
.....
.....
.....
.....
.....
.....
.....
.....
.....
.....
.....
.....
.....
.....
.....
.....
.....
.....
.....
.....
.....
.....
.....
.....
.....
.....
.....
.....
.....
.....
.....
.....
.....
.....
.....
.....
.....
.....
.....

.....
.....
.....
.....
.....
.....
.....
.....
.....
.....
.....
.....
.....
.....
.....
.....
.....
.....
.....
.....
.....
.....
.....
.....
.....
.....
.....
.....
.....
.....
.....
.....
.....
.....
.....
.....
.....
.....
.....
.....
.....
.....
.....
.....
.....
.....
.....
.....
.....
.....
.....
.....
.....
.....
.....
.....
.....
.....
.....
.....
.....
.....
.....
.....
.....
.....
.....
.....

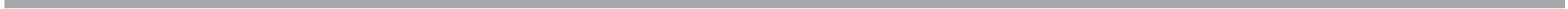

Dotted lines for writing on the left side of the page.

Dotted lines for writing on the right side of the page.

Toshiba Carrier Corporation

336 TADEHARA, FUJI-SHI, SHIZUOKA-KEN 416-8521 JAPAN

EB99831601