

# TOSHIBA

**R410A & R134a**

For commercial use

*HOT WATER MODULE (MULTI TYPE)*

## Owner's Manual

### Indoor Unit

Model name:

---

Mid temperature Hot Water Module  
(Refrigerant R410A type)

**MMW-AP0271LQ-E**

**MMW-AP0561LQ-E**

High temperature Hot Water Module  
(Refrigerant R410A and R134a type)

**MMW-AP0481CHQ-E**

**Original instruction**

Thank you very much for purchasing TOSHIBA Hot Water Module.  
Please read this owner's manual carefully before using your Hot Water Module.

- Be sure to obtain the "Owner's manual" and "Installation manual" from constructor (or dealer).

Request to constructor or dealer

- Please clearly explain the contents of the Owner's manual and hand over it.
- Please ask user to keep the Owner's manual in a safe place for future reference.

**ADOPTION OF R410A & R134a REFRIGERANT**

Hot Water Module adopts a HFC refrigerant (R410A or R134a) in order to prevent destruction of the ozone layer.

This appliance can be used by children aged from 8 years and above and persons with reduced physical, sensory or mental capabilities or lack of experience and knowledge if they have been given supervision or instruction concerning use of the appliance in a safe way and understand the hazards involved. Children shall not play with the appliance. Cleaning and user maintenance shall not be made by children without supervision.

**Contents**

<b>1</b>	<b>Precautions for safety</b>	<b>3</b>
<b>2</b>	<b>Part names</b>	<b>6</b>
<b>3</b>	<b>Part names and functions of the remote controller</b>	<b>6</b>
<b>4</b>	<b>Basic operation</b>	<b>9</b>
<b>5</b>	<b>Timer operation</b>	<b>9</b>
<b>6</b>	<b>Installation</b>	<b>10</b>
<b>7</b>	<b>Notes on operations and performance</b>	<b>10</b>
<b>8</b>	<b>Maintenance</b>	<b>11</b>
<b>9</b>	<b>Troubleshooting</b>	<b>12</b>
<b>10</b>	<b>Specifications</b>	<b>13</b>

Please read carefully through these instructions that contain important information, and ensure that you understand them.

**Generic Denomination: Hot Water Module**





**Definition of Qualified Installer or Qualified Service Person**

The hot water module must be installed, maintained, repaired and removed by a qualified installer or qualified service person. When any of these jobs is to be done, ask a qualified installer or qualified service person to do them for you.

A qualified installer or qualified service person is an agent who has the qualifications and knowledge described in the table below.

Agent	Qualifications and knowledge which the agent must have
Qualified installer	<ul style="list-style-type: none"> <li>The qualified installer is a person who installs, maintains, relocates and removes the air conditioners (including the hot water modules) made by Toshiba Carrier Corporation. He or she has been trained to install, maintain, relocate and remove the air conditioners (including the hot water modules) made by Toshiba Carrier Corporation or, alternatively, he or she has been instructed in such operations by an individual or individuals who have been trained and is thus thoroughly acquainted with the knowledge related to these operations.</li> <li>The qualified installer who is allowed to do the electrical work involved in installation, relocation and removal has the qualifications pertaining to this electrical work as stipulated by the local laws and regulations, and he or she is a person who has been trained in matters relating to electrical work on the air conditioners (including the hot water modules) made by Toshiba Carrier Corporation or, alternatively, he or she has been instructed in such matters by an individual or individuals who have been trained and is thus thoroughly acquainted with the knowledge related to this work.</li> <li>The qualified installer who is allowed to do the refrigerant handling and piping work involved in installation, relocation and removal has the qualifications pertaining to this refrigerant handling and piping work as stipulated by the local laws and regulations, and he or she is a person who has been trained in matters relating to refrigerant handling and piping work on the air conditioners (including the hot water modules) made by Toshiba Carrier Corporation or, alternatively, he or she has been instructed in such matters by an individual or individuals who have been trained and is thus thoroughly acquainted with the knowledge related to this work.</li> <li>The qualified installer who is allowed to work at heights has been trained in matters relating to working at heights with the air conditioners (including the hot water modules) made by Toshiba Carrier Corporation or, alternatively, he or she has been instructed in such matters by an individual or individuals who have been trained and is thus thoroughly acquainted with the knowledge related to this work.</li> </ul>
Qualified service person	<ul style="list-style-type: none"> <li>The qualified service person is a person who installs, repairs, maintains, relocates and removes the air conditioners (including the hot water modules) made by Toshiba Carrier Corporation. He or she has been trained to install, repair, maintain, relocate and remove the air conditioners (including the hot water modules) made by Toshiba Carrier Corporation or, alternatively, he or she has been instructed in such operations by an individual or individuals who have been trained and is thus thoroughly acquainted with the knowledge related to these operations.</li> <li>The qualified service person who is allowed to do the electrical work involved in installation, repair, relocation and removal has the qualifications pertaining to this electrical work as stipulated by the local laws and regulations, and he or she is a person who has been trained in matters relating to electrical work on the air conditioners (including the hot water modules) made by Toshiba Carrier Corporation or, alternatively, he or she has been instructed in such matters by an individual or individuals who have been trained and is thus thoroughly acquainted with the knowledge related to this work.</li> <li>The qualified service person who is allowed to do the refrigerant handling and piping work involved in installation, repair, relocation and removal has the qualifications pertaining to this refrigerant handling and piping work as stipulated by the local laws and regulations, and he or she is a person who has been trained in matters relating to refrigerant handling and piping work on the air conditioners (including the hot water modules) made by Toshiba Carrier Corporation or, alternatively, he or she has been instructed in such matters by an individual or individuals who have been trained and is thus thoroughly acquainted with the knowledge related to this work.</li> <li>The qualified service person who is allowed to work at heights has been trained in matters relating to working at heights with the air conditioners (including the hot water modules) made by Toshiba Carrier Corporation or, alternatively, he or she has been instructed in such matters by an individual or individuals who have been trained and is thus thoroughly acquainted with the knowledge related to this work.</li> </ul>

**Warning indications on the hot water module**

Warning indication	Description		
 <table border="1" data-bbox="1303 276 1554 432"> <tr> <td data-bbox="1303 276 1554 323"><b>WARNING</b></td> </tr> <tr> <td data-bbox="1303 330 1554 432"><b>ELECTRICAL SHOCK HAZARD</b> Disconnect all remote electric power supplies before servicing.</td> </tr> </table>	<b>WARNING</b>	<b>ELECTRICAL SHOCK HAZARD</b> Disconnect all remote electric power supplies before servicing.	<p><b>WARNING</b></p> <p><b>ELECTRICAL SHOCK HAZARD</b> Disconnect all remote electric power supplies before servicing.</p>
<b>WARNING</b>			
<b>ELECTRICAL SHOCK HAZARD</b> Disconnect all remote electric power supplies before servicing.			
 <table border="1" data-bbox="1303 483 1554 639"> <tr> <td data-bbox="1303 483 1554 531"><b>WARNING</b></td> </tr> <tr> <td data-bbox="1303 537 1554 639">Moving parts. Do not operate unit with grille removed. Stop the unit before the servicing.</td> </tr> </table>	<b>WARNING</b>	Moving parts. Do not operate unit with grille removed. Stop the unit before the servicing.	<p><b>WARNING</b></p> <p>Moving parts. Do not operate unit with grille removed. Stop the unit before the servicing.</p>
<b>WARNING</b>			
Moving parts. Do not operate unit with grille removed. Stop the unit before the servicing.			
 <table border="1" data-bbox="1303 691 1554 847"> <tr> <td data-bbox="1303 691 1554 738"><b>CAUTION</b></td> </tr> <tr> <td data-bbox="1303 745 1554 847">High temperature parts. You might get burned when removing this panel.</td> </tr> </table>	<b>CAUTION</b>	High temperature parts. You might get burned when removing this panel.	<p><b>CAUTION</b></p> <p>High temperature parts. You might get burned when removing this panel.</p>
<b>CAUTION</b>			
High temperature parts. You might get burned when removing this panel.			
 <table border="1" data-bbox="1303 898 1554 1054"> <tr> <td data-bbox="1303 898 1554 946"><b>CAUTION</b></td> </tr> <tr> <td data-bbox="1303 952 1554 1054"><b>BURST HAZARD</b> Open the service valves before the operation, otherwise there might be the burst.</td> </tr> </table>	<b>CAUTION</b>	<b>BURST HAZARD</b> Open the service valves before the operation, otherwise there might be the burst.	<p><b>CAUTION</b></p> <p><b>BURST HAZARD</b> Open the service valves before the operation, otherwise there might be the burst.</p>
<b>CAUTION</b>			
<b>BURST HAZARD</b> Open the service valves before the operation, otherwise there might be the burst.			
 <table border="1" data-bbox="1303 1106 1554 1262"> <tr> <td data-bbox="1303 1106 1554 1153"><b>CAUTION</b></td> </tr> <tr> <td data-bbox="1303 1160 1554 1262"><b>Do not climb onto the top side.</b> Doing so may result in injury.</td> </tr> </table>	<b>CAUTION</b>	<b>Do not climb onto the top side.</b> Doing so may result in injury.	<p><b>CAUTION</b></p> <p><b>Do not climb onto the top side.</b> Doing so may result in injury.</p>
<b>CAUTION</b>			
<b>Do not climb onto the top side.</b> Doing so may result in injury.			

# 1 Precautions for safety

The manufacturer shall not assume any liability for the damage caused by not observing the description of this manual.

## WARNING

### General

- Carefully read Owner's Manual before starting the hot water module. There are many important things to keep in mind for daily operation.
- Ask for installation to be performed by the dealer or a professional. Only a qualified installer (\*1) is able to install a hot water module. If a non-qualified person installs a hot water module, it may result in problems such as fire, electric shock, injury, water leakage, noise and vibration.
- Do not use any refrigerant different from the one specified for complement or replacement. Otherwise, abnormally high pressure may be generated in the refrigeration cycle, which may result in a failure or explosion of the product or an injury to your body.
- This appliance is intended to be used by expert or trained users in shops, in light industry, or for commercial use by lay persons.

### Installation

- Only a qualified installer (\*1) or qualified service person (\*1) is allowed to carry out the electrical work of the hot water module. Under no circumstances must this work be done by an unqualified individual since failure to carry out the work properly may result in electric shocks and/or electrical leaks.
- After the installation work has been completed, have the installer explain about the circuit breaker positions. In the event that trouble has occurred in the hot water module, set the circuit breaker to the OFF position, and contact a service person.
- If you install the unit in a small room, take appropriate measures to prevent the refrigerant from exceeding the limit concentration even if it leaks. Consult the dealer from whom you purchased the hot water module when you implement the measures. Accumulation of highly concentrated refrigerant may cause an oxygen deficiency accident.
- Do not install the hot water module in a location that may be subject to a risk of expire to a combustible gas. If a combustible gas leaks and becomes concentrated around the unit, a fire may occur.

- Be sure to use the company-specified products for the separately purchased parts. Use of non-specified products may result in fire, electric shock, water leakage, etc. Have the installation performed by a professional.
- Confirm that earthing is performed correctly.

### Operation

- Inside the air conditioner and the hot water module are high-voltage areas and rotating parts. Due to the danger of electric shocks or of your fingers or physical objects becoming trapped in the rotating parts, do not remove the front panel of the hot water module or service panel of the outdoor unit. When work involving the removal of these parts is required, contact a qualified installer or a qualified service person.
- Do not move or repair any unit by yourself. Since there is high voltage inside the unit, you may get electric shock when removing the cover and main unit.
- Do not touch the plate heat exchanger of the unit. You may injure yourself if you do so. If the plate heat exchanger must be touched, do not touch it yourself but contact a qualified installer or a qualified service person.
- Do not climb onto or place objects on top of the outdoor unit. You may fall or the objects may fall off of the outdoor unit and result in injury.
- When the hot water module is operated with a combustion appliance in the same place, be careful of ventilation to let fresh air enter the room. Poor ventilation causes oxygen shortage.
- When the hot water module is used in a closed room, be careful of sufficient ventilation of the room. Poor ventilation causes oxygen shortage.
- Consult the shop where you purchased the hot water module if water heating is not performed properly as a refrigerant leakage may be the cause. Confirm the repair details with a qualified service person (\*1) when the repair includes additional charging of the refrigerant.

### Repairs

- When you have noticed that some kind of trouble (such as when a check display has appeared, there is a smell of burning, abnormal sounds are heard, the hot water module fails heat or water is leaking) has occurred in the hot water module, do not touch the hot water module yourself but set the circuit breaker to the OFF position, and contact a qualified service person. Take steps to ensure that the

---

power will not be turned on (by marking “out of service” near the circuit breaker, for instance) until qualified service person arrives. Continuing to use the hot water module in the trouble status may cause mechanical problems to escalate or result in electric shocks, etc.

- If you have discovered that the fan grille is damaged, do not approach the outdoor unit but set the circuit breaker to the OFF position, and contact a qualified service person to have the repairs done. Do not set the circuit breaker to the ON position until the repairs are completed.
- If you have discovered that there is a danger of the outdoor and the hot water module unit’s toppling over, do not approach the outdoor and the hot water units but set the circuit breaker to the OFF position, and contact a qualified installer or a qualified service person to have the improvements or refitting done. Do not set the circuit breaker to the ON position until the improvements or refitting is completed.
- Do not customize the unit. Doing so may result in fire, electric shock, etc.

#### **Relocation**

- When the hot water module is to be relocated, do not relocate it yourself but contact a qualified installer or a qualified service person. Failure to relocate the hot water module properly may result in electric shocks and/or a fire.
- 

---

#### **⚠ CAUTION**

##### **To disconnect the appliance form the main supply**

- This appliance must be connected to the mains by means of a switch with a contact separation of at least **3 mm**.

##### **Installation**

- Certainly lay the drain hose for perfect draining. Bad drainage may cause flooding in the house and getting furniture wet.
- Make sure to connect the hot water module to an exclusive power supply of the rated voltage, otherwise the unit may break down or cause a fire.
- Confirm that the outdoor unit and the hot water module are fixed on the base. Otherwise, falling down of the units or other accidents may occur.

##### **Operation**

- Do not use this hot water module for special purpose such as preserving food, precision instruments, art objects, breeding animals, car, vessel, etc.
- Do not touch any switches with wet finger, otherwise you may get an electric shock.
- If the air conditioner system (including hot water module) will not be used for a considerably long time, turn off the main switch or the circuit breaker, for safety.
- To make the hot water module operate in its original performance, operate it within the range of the operating temperature specified in the instructions. Otherwise it may cause a malfunction, or water leak from the unit.
- Prevent any liquid from falling into the remote controller. Do not spill juice, water or any kind of liquid.
- Do not wash the hot water module. Doing so may result in electric shock.
- Check whether the installation base and other equipment have become deteriorated after being used for a long time. Leaving them such condition may result in the unit’s falling down and causing injury.
- Do not leave flammable sprays or other flammable materials near the hot water module, and do not spray flammable aerosol directly to the hot water module. They may catch fire.

- Ask for cleaning of the hot water module to be performed by the dealer.  
Cleaning the hot water module in an improper manner may cause insulation failure of electric parts, etc. and result in a malfunction. In the worst case, it may result in water leakage, electric shock, smoke emission and fire.
- Do not put a water container such as a vase on the unit.  
Water intrusion into the unit may occur and it may cause deterioration of electric insulation and result in electric shock.











**Note:**

Before you run the compressor, always confirm that the hot water module is operable (power on, address fixed, communication wiring complete).  
Failure to do this will cause the heat exchanger in the hot water module to freeze, rupture, and leak water.

(\*1) Refer to the "Definition of Qualified Installer or Qualified Service Person."

**Information on the transportation, handling and storage of the carton**

**Examples of indication on the carton**

Symbol	Description	Symbol	Description	Symbol	Description
	Keep dry		Do not drop		Do not lay it
	Fragile	 2 cartons	Stacking height (2 cartons can be stacked in this case)		Handle with care
	This side up		Do not step		Do not drop
			Do not roll		Do not clamp as indicated

	<p><b>Caution</b></p> <p>Injury possibility. Don't handle with packing band, or may get injured in case of broken band.</p>
<p><b>CAUTION</b> Injury possibility. Don't handle with packing band, or may get injured in case of broken band.</p>	

## 2 Part names

### ■ Mid temperature Hot Water Module

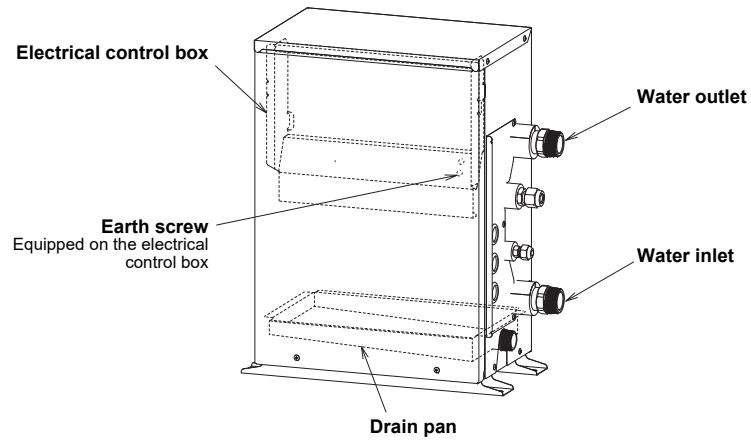

### ■ High temperature Hot Water Module

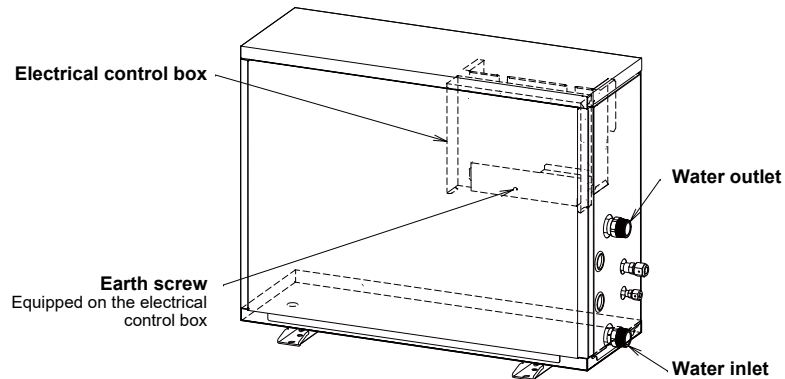

## 3 Part names and functions of the remote controller

### 3-1. Standard remote controller (RBC-AMT32E)

#### ■ Display section

All indicators are displayed in the display example below. Actually, only the selected options will be displayed.

- **SETTING** blinks on the display of the remote controller the first time the power switch is turned on.
- The initial settings progress while **SETTING** is blinking. Start to use the remote controller after **SETTING** has disappeared.

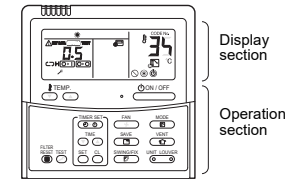

#### NOTE

The LCD may temporarily be blurred due to static electricity.

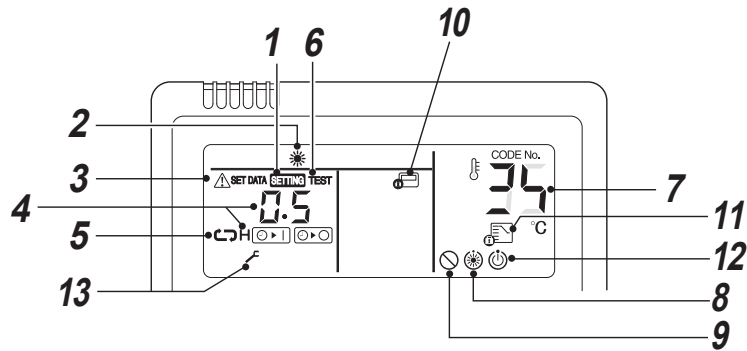

- 1 SETTING indicator**  
Displayed when setting the timer or other functions.
- 2 Operation mode indicator**  
Indicates the operation mode selected.
- 3 Check code indicator**  
Displayed when the protective device activates or a trouble occurs.
- 4 Time display**  
Indicates time concerning the timer.  
(Indicates a check code when a trouble occurs)
- 5 Timer mode indicator**  
Displays the timer mode.
- 6 TEST run indicator**  
Displayed during test run.
- 7 Set temperature display**  
The selected set temperature is displayed.
- 8 Pre-heat indicator**  
Displayed when defrost cycle is initiated.
- 9 No function indicator**  
Displayed when the function requested is not available on that model.

- 10 Central control indicator**  
Displayed when the air conditioner is controlled centrally and used with central control devices such as the central remote controller.  
If the use of the remote controller is prohibited by the central control, blinks when the ON/OFF, MODE, or TEMP. button on the remote controller is pushed, and the buttons do not function. (Settings that can be configured on the remote controller differ depending on the mode of the central control. For details, read the Owner's Manual of the central remote controller.)
- 11 Operation mode controlled indicator**  
Displayed when the operation mode is restricted.
- 12 Operation ready display**  
This display appears on some models.
- 13 Service display**  
Displayed while the protective device works or a trouble occurs.

**CAUTION**

Remote controller sensor cannot be used for the hot water module. Remote controller sensor has no function when remote controller is connected to the hot water module.

**Operation section**

Once the settings have been configured, all you need to do is push the button from then on.

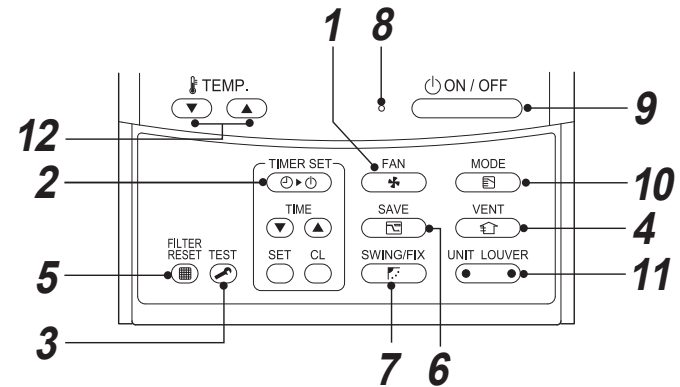

- 1 button (Fan speed select button)**  
No function.
- 2 button (Timer set button)**  
Use to setup the timer.
- 3 button (TEST button)**  
Use only for service.  
(During normal operation, do not use this button.)
- 4 button**  
No function.
- 5 button (Filter reset button)**  
No function.
- 6 button (Power save operation)**  
No function.
- 7 button**  
No function.
- 8 **Operation lamp****  
Lights up during running.  
Blinks when a trouble occurs or the protective device activates.
- 9 button**  
Turns on the unit when pushed, and turns off when pushed again.
- 10 button (Operation mode select button)**  
Heating mode is only available. Only heating symbol is displayed.
- 11 button (Unit / Louver select button)**  
**UNIT button:**  
No function.  
**LOUVER button:**  
No function.
- 12 button**  
Adjusts the set temperature.  
Select the desired set point by pushing or .



## 3-2. Wired remote controller (RBC-AMS55E-ES/EN)

<Only for High temperature Hot Water Module>

Refer to Owner's Manual of RBC-AMS55E-ES/EN for the detailed operation method.

- Only High temperature Hot Water Module can operate with the RBC-AMS55E-ES/EN remote controller.

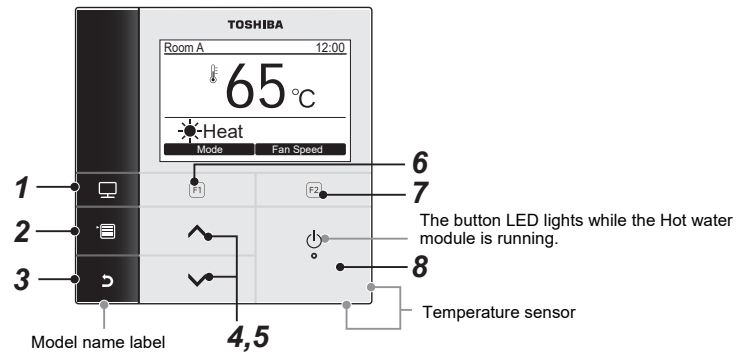

- [MONITOR] button**  
Displays the monitoring screen.
- [MENU] button**  
Displays the menu screen.  
For menu items, refer to following table.
- [CANCEL] button**  
Functions as indicated on the screen, such as returning to the previous menu screen.
- [▲ ▲] button**  
During normal operation: adjusts the temperature.  
On the menu screen: selects a menu item.
- [▼ ▼] button**  
During normal operation: adjusts the temperature.  
On the menu screen: selects a menu item.
- [F1] button**  
Varies its function according to the setting screen.
- [F2] button**  
Varies its function according to the setting screen.
- [ON/OFF] button**  
The button LED lights while the Hot water module is running.

Menu items	High temperature Hot Water Module	
	Available function	No function
1 Wind Direction		✓
2 Individual louver		✓
3 Louver setting		✓
4 Off reminder timer	✓	
5 Schedule timer	✓	
6 Night operation	✓	
7 Filter sign		✓
8 Auto grille		✓
9 Energy saving		✓
10 Initial setting		✓
11 Ventilation		✓
12 Soft cooling setting		✓
13 Occupancy sensor		✓
14 Power consumption		✓
15 Information	✓	

### Switching between the normal display and detailed display

Push and hold the [CANCEL] button and [MONITOR] button at the same time for more than 4 seconds to switch the display mode.

The normal display mode is selected as a factory default setting.

#### Normal display mode (factory default)

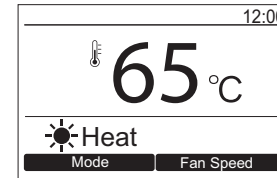

#### Detailed display mode

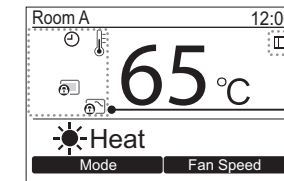

Icons appear on the screen when the detailed display mode is selected.

#### ▼ Icon list

	Shows the central control device prohibits the use of the remote controller		Shows a timer function is activated.
	Shows operation switching control is in progress.		

# 4 Basic operation

When you use the hot water module for the first time or change the settings, follow the procedures below.  
From next time, pushing the  button starts running of the hot water module with the chosen settings.

## ■ Preparation

### Turn on the power switch





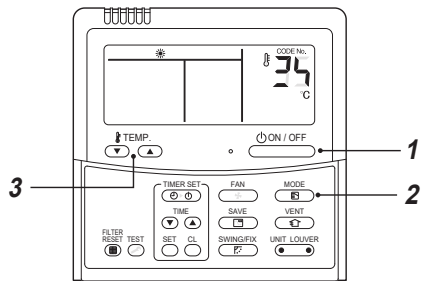

- When turned on, the separation line appears and **SETTING** blinks on the remote controller display.
- \* The remote controller will not work for about 1 minute after turning on the power. This is not a malfunction.

### REQUIREMENT

- Keep the power switch turned on during use.
- When you resume using the hot water module after a long period of disuse, turn on the power switch at least 12 hours before starting running.

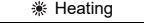
## ■ Operations



- Push the  button.  
The operation lamp lights up.
- Push the “MODE ” button to select a operation mode.  
Only heating symbol is displayed. Heating mode is only available.  

- Push the “TEMP.  ” buttons.  
Push  to increase the temperature, and  to decrease the temperature.

	Operation mode	Setting range	Factory default
Mid temperature Hot Water Module	HEAT	25 to 50 °C	35 °C
High temperature Hot Water Module	HEAT	50 to 82 °C	65 °C

- Push the  button to stop running.  
The operation lamp turns off.

# 5 Timer operation

Select a timer type from the following three: (Max. 168 hours)

- OFF timer** : Stops running after the specified period.
- Repeat-OFF timer** : Stops running after the specified period every time you use the hot water module.
- On timer** : Starts running after the specified period.

## ■ Setting the timer

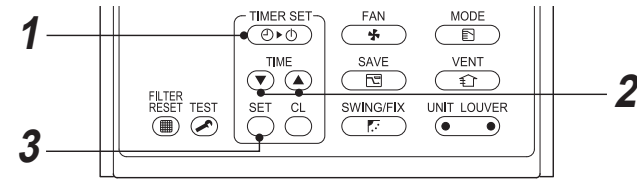



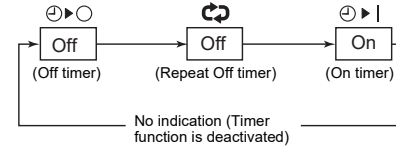



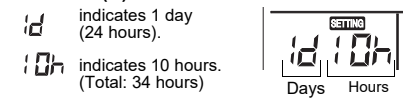

- Push the  button.  
Each time you push the button, the timer mode and indication change in the following order:



- 34 hours (\*2)



- Push the  button.  
**SETTING** disappears, the time indication is displayed, and  or  display flashes.  
(When using the ON timer, all indications other than the time and  turn off.)

- **SETTING** and the time indicator blink.
- Push the   buttons to set the period of time until the timer actions.
    - The time setting increases in 0.5-hour (30-minute) increments each time you push .
    - The setting increases in 1-hour increments if it is over 1d (24 hours). The maximum is 7d (168 hours).
    - On the remote controller, settings between 0.5h and 23.5h (\*1) are displayed as is.
    - If it is over 24 hours (\*2), the days and hours appear.
    - The time setting decreases in 0.5-hour (30-minute) decrements (0.5 hours to 23.5 hours) or 1-hour decrements (24 hours to 168 hours) each time you push .

## ■ Cancelling the timer

- Push the  button.  
The timer indicator disappears.

### NOTE

When using Repeat OFF timer, pushing the  button after stopping by the timer starts running again and the timer will stop the running again after the specified period.

### Example of remote controller display

- 23.5 hours (\*1)



## 6 Installation

### ■ Location

- Hot water module is allowed to install indoors.
  - Avoid installing near machines emitting high frequency waves.
  - Not suitable for chemical plants such as liquefied carbon dioxide refrigerant plants.
  - Do not install the hot water module in locations where iron or other metal dust is present. If iron or other metal dust adheres to or collects on the interior of the hot water module, it may spontaneously combust and start a fire.
  - A failure may occur in certain locations such as the following:
    - Areas with large amount of oil droplets (including machine oil) or vapors
    - Salty areas near oceans, etc.
    - Hot springs emitting sulfidizing gas, etc.
    - Heavily acidic or alkaline places.
- Special maintenance or parts are required for use in the above places. For details, contact the dealer where you purchased the product.
- Leave an enough space around the air intake and discharge of the outdoor unit so that the ventilation is not restricted.
  - Avoid places where strong wind may blow against the air intake and discharge of the outdoor unit.
  - Attach a snow stand, snow hood, etc. to the outdoor unit for use in snowfall areas. For details, contact the dealer where you purchased the product.
  - Make sure drain water from the outdoor unit and the hot water module are emitted into places with good drainage.
  - Keep a distance of at least 1 m between the hot water module / remote controller and a TV or radio. Failure to observe this precaution may cause visual disturbance or noise.
  - Leave a distance of at least 1.5 m between the hot water module and a fire alarm. If this precaution is not observed, the alarm may not work properly or detect fire in case of fire.

### ■ Be careful of operation sounds

- Locate the unit in a place secure enough so that the sounds and vibrations do not increase.
- If something is placed near the air discharge of the outdoor unit, noise may increase.
- Be careful not to disturb your neighbors with cool / heat air or noise coming from the air discharge of the outdoor unit.
- Do not install the Hot water module in locations where the operation sound may cause a disturbance. (Especially at the boundary line with a neighbor, do not install the Hot water module in locations where considering the noise.)
- Location such as living rooms and bed rooms where you can easily be bothered by noise. Noise may become a problem.

## 7 Notes on operations and performance

### ■ Check before operation

- Turn on the power switch at least 12 hours before starting operation.
- Make sure the earth wire is securely connected.

### ■ Defrosting during heating

- If frost falls on the outdoor unit during heating, defrosting is automatically performed (for approximately 2 - 10 minutes) to increase the heating effect.
- The Hot water module keeps operating the pump during defrosting.
- The hot water module stops the compressor operation during defrosting. (For High temperature Hot water module type.)

### ■ 3-minute protection

The outdoor unit will not operate for approximately 3 minutes after the air conditioner (including hot water module) has been immediately restarted after stopping, or the power switch has been turned on. This is to protect the system.

### ■ Power failure

- In the case of a power failure, all operations stop.
- To resume operations, push the ON/OFF button.

### ■ Protective device (High pressure switch)

The high pressure switch stops the air conditioner (including hot water module) automatically when excessive load is applied to the air conditioner system. If the protective device activates, the unit's running stops and the operation lamp blinks. When the protective device activates, the  indicator and the check code are displayed on the remote controller.

The protective device may activate in the following cases:

#### During cooling

- When the air intake or air discharge of the outdoor unit is blocked.
- When strong wind blows continuously against the air discharge of the outdoor unit.

#### During heating

- When dust or dirt is excessively adhered to the strainer (locally procured) of water pipe.
- When the water flow rate is lower.

#### NOTE



When the protective device activates, turn off the power switch, remove the cause, and then restart running.

### ■ Protective operations (For High temperature Hot Water Module)

When the water temperature is low, the hot water module stops.

### ■ Cooling / Heating operations

#### <Connecting to SMMS-e>

Each unit can be controlled individually. However, indoor units connected to the same outdoor unit cannot perform cooling and heating simultaneously. When you attempt simultaneous operation, hot water module performing heating are stopped, and the running preparation indicator  is displayed on the remote controller. An indoor unit performing cooling continues running. When you attempt an operation without the configured settings, the running preparation indicator  is displayed on the remote controller and operation stops. If operation is fixed to cooling or heating by the air conditioner administrator, only the configured settings apply to the operation.

### <Connecting to SHRM-e>

- If the Standard indoor unit is used at outside temperature out of the operating conditions, safety protection may operate, which may cause cooling or heating not to operate.  
At that time, "⊗" Pre-heat indicator lights on the operation section.

### ■ Characteristics of heating

- When the outside temperature increases, the outdoor unit may stop.
- When the outside temperature increases, the hot water module can operate while other indoor units may not operate heating but can operate cooling. (For High temperature Hot Water Module type.)
- When indoor unit and Hot water module are simultaneously operated under the low outside temperature, operation start of the indoor unit may be delayed.

### ■ Characteristics of simultaneously heating or cooling (SHRM-e)

- When the outside temperature lower during operation, the outdoor fan may stop.

## 8 Maintenance

### ⚠ WARNING

**For daily maintenance, make sure to ask the qualified service person particularly following models as the maintenance requires high-place work;**

### ■ Cleaning the hot water module and remote controller

- Ask qualified service person to clean the hot water module for the models listed in the warning on the top of this chapter.
- Wipe with a dry, soft cloth.
- Do not use benzine, thinner, scouring powder, chemical cloth, etc. as those may cause deformation or breakage.



### ■ If unused for over a month

- Before a long period of none use, purge the water out of the pipes and thoroughly let them dry. (The water in piping freezes in winter.)
- Turn off the main power switch.

### ■ Periodic inspection

- After being used for a long period of time, the parts may deteriorate or malfunction, or the drainage may worsen, due to heat, moisture, dust, or general usage.
- In addition to the maintenance, it is recommended that you have a inspection (charges apply) performed by the dealer where you purchased the unit, etc.

### ■ Before the operating season

Ask a qualified service person to clean the drain pan.

### ⚠ CAUTION

#### Clean the drain pan

Without cleaning, the drain pan may be filled with waste, and water may overflow onto the floor.

# 9 Troubleshooting

When the following symptoms are found, check the points described below before asking repair servicing.

		Symptom	Cause
It is not a failure.	Outdoor unit	<ul style="list-style-type: none"> <li>White misty cold air or water is out.</li> <li>Sometimes, noise of air leak is heard.</li> </ul>	<ul style="list-style-type: none"> <li>Fan of the outdoor unit stops automatically and performs defrost operation.</li> <li>Solenoid valve works when defrost operation starts or finishes.</li> </ul>
	Hot water module	<ul style="list-style-type: none"> <li>"Swish" sound is heard sometimes.</li> <li>"</li>" indication is lit. <li>"</li>" indication is lit. <li>Sound is output from the stand by hot water module.</li> </ul>	<ul style="list-style-type: none"> <li>When the operation has started, during the operation, or immediately after the operation has stopped, a sound such as water flows may be heard, and the operation sound may become larger for 2 or 3 minutes immediately after the operation has started. They are flowing sound of refrigerant or draining sound of dehumidifier.</li> <li>When heating operation cannot be performed because another indoor unit performs cooling operation. (SMMS-e only)</li> <li>Is outside temperature out of operation temperature range?</li> <li>When the manager of the air conditioner or the hot water module has fixed the operation to COOL or HEAT, and an operation contrary to the setup operation is performed.</li> <li>Since refrigerant is flowed temporarily to prevent stay of oil or refrigerant, sound of flowing refrigerant may be heard when hot water module operates in HEAT mode.</li> </ul>
	Pump, Line heater	<ul style="list-style-type: none"> <li>The pump and line heater operates automatically during hot water module is stand by.</li> <li>When power of the hot water module is turned on, "Ticktock" sound is heard.</li> <li>LCD blurs when it is touched.</li> </ul>	<ul style="list-style-type: none"> <li>The pump and line heater operates for frost protection of water heat exchanger, when water temperature decreases or outdoor unit start operation or refrigerant (oil) recovery control.</li> <li>Sound is generated when the expansion valve operates when power has been turned on.</li> <li>LCD may temporarily blur by static electricity.</li> </ul>
Check again.	Operates or stops automatically.		<ul style="list-style-type: none"> <li>Is the timer "ON" or "OFF"?</li> </ul>
	Does not operate.		<ul style="list-style-type: none"> <li>Is it a power failure?</li> <li>Is the power switch turned off?</li> <li>Is the power fuse or breaker blown?</li> <li>Has the protective device operated? (The operation lamp goes on.)</li> <li>Is the timer "ON"? (The operation lamp goes on.)</li> <li>Are COOL and HEAT selected simultaneously?</li> <li>"</li>" indication is lit on the display of the remote controller. (SMMS-e only) <li>Is outside temperature out of operation temperature range?</li> <li>Is water temperature becoming low at the inlet side of Hot water module? If water temperature at the inlet for Hot water module is low, the Hot water module may sometimes stop to prevent it from freezing.</li> </ul>
	Water is not warmed sufficiently?		<ul style="list-style-type: none"> <li>Is the water supply or water discharge in water piping obstructed?</li> <li>Is appropriate temperature on remote controller set?</li> <li>Is outside temperature out of operation temperature range?</li> <li>Are indoor unit and Hot water module simultaneously operated in heating? If total operation capacity is large, water may be difficult to be warmed sufficiently.</li> </ul>



For proper performance, operate the Hot water module under the following temperature conditions:

Heating operation	Outdoor temperature	: -25° to 28°C (Wet-bulb temperature)
	Room temperature	: 5 to 32°C (Dry-bulb temperature)

\* Low ambient heating (-20°C or less ) for extended periods of time is not allowed.

## CAUTION

If any of the following conditions occur, turn off the main power supply switch and immediately contact the dealer:

- Switch operation does not work properly.
- The main power fuse often blows out, or the circuit breaker is often activated.
- A foreign matter or water fall inside the hot water module.
- When the hot water module does not operate even after the cause of the protective device activation has been removed. (The operation lamp and  on the remote controller are flashing. When  and a combination of *R*, *E*, *F*, *H*, *L*, or *P* and a number are displayed on the remote controller, also inform a qualified service person of the display content.)
- Any other unusual conditions are observed.

**Confirmation and check**

When a trouble occurred in the air conditioner or the hot water module, the check code and the indoor unit No. appear on the display part of the remote controller.

The check code is only displayed during the operation.

If the display disappears, operate the air conditioner or hot water module according to the following "Confirmation of trouble log" for confirmation.

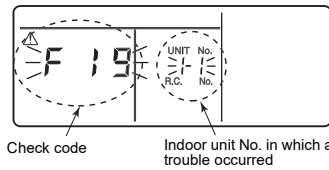

**Confirmation of trouble log**

When a trouble occurred on the air conditioner or the hot water module, the trouble log can be confirmed with the following procedure. (The trouble log is stored in memory up to 4 troubles.)

The log can be confirmed from both operating status and stop status.

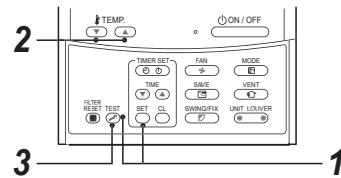

Procedure	Description
<b>1</b>	<p>When pushing <b>TEST</b> and <b>TEMP</b> buttons at the same time for 4 seconds or more, the following display appears.</p> <p>If [Service check] is displayed, the mode enters in the trouble log mode.</p> <ul style="list-style-type: none"> <li>• [01: Order of trouble log] is displayed in CODE No. window.</li> <li>• [Check code] is displayed.</li> <li>• [Indoor unit address in which a trouble occurred] is displayed in UNIT No.</li> </ul>
<b>2</b>	<p>Every pushing of [TEMP] button used to set temperature, the trouble log stored in memory is displayed in order.</p> <p>The numbers in CODE No. indicate CODE No. [01] (latest) to [04] (oldest).</p> <p><b>CAUTION</b> Do not push <b>TEST</b> button because all the trouble log of the indoor unit will be deleted.</p>
<b>3</b>	<p>After confirmation, push <b>TEST</b> button to return to the usual display.</p>

1. Check the troubles according to the above procedure.
2. Ask an authorized dealer or qualified service (maintenance) professional to repair or maintain the air conditioner or the hot water module.
3. More details of the check code are explained in Service Manual.

# 10 Specifications

Model	Sound pressure level (dB(A))	Weight (kg) Main unit
	Heating	
MMW-AP0271LQ-E	*	17.8
MMW-AP0561LQ-E	*	20.3
MMW-AP0481CHQ-E	*	100

\* Under 70 dB(A)

**Hot water module operating conditions**

For proper performance, operate the hot water module under the following temperature conditions:

**Mid temperature Hot Water Module**

Heating operation	Outside temperature (Heat pump)	: -20°C to 19°C (Wet bulb temp.)
	Outside temperature (Heat recovery)	: -25°C to 28°C (Wet bulb temp.)
	Water inlet temperature	: 15°C to below 50°C
Indoor atmosphere	Indoor temperature	: 5°C to 32°C (Dry bulb temp.)
	Indoor Relative humidity	: 24 or less (Wet bulb temp.)
	Allowable dew point	: 30% to 85%
		: 23 or less (Wet bulb temp.)

**CAUTION** Be careful of installation atmosphere. It becomes a cause of failure of a product by dewing or freezing.

If hot water module is used outside of the above conditions, safety protection may operate.

**High temperature Hot Water Module**

Heating operation	Outside temperature (Heat recovery)	: -25°C to 28°C (Wet bulb temp.)
	Water inlet temperature	: 15°C to below 80°C
Indoor atmosphere	Indoor temperature	: 5°C to 32°C (Dry bulb temp.)
	Indoor Relative humidity	: 24 or less (Wet bulb temp.)
	Allowable dew point	: 30% to 85%
		: 23 or less (Wet bulb temp.)

**CAUTION** Be careful of installation atmosphere. It becomes a cause of failure of a product by dewing or freezing.

If hot water module is used outside of the above conditions, safety protection may operate.

---

## ***Declaration of Conformity***

Manufacturer: TOSHIBA CARRIER CORPORATION  
336 Tadehara, Fuji-shi, Shizuoka-ken 416-8521 JAPAN

TCF holder: TOSHIBA CARRIER EUROPE S.A.S  
Route de Thil  
01120 Montluel FRANCE

Hereby declares that the machinery described below:

Generic Denomination: Hot Water Module

Model / type: MMW-AP0481CHQ-E

Commercial name: Super Heat Recovery Multi System Air Conditioner

Complies with the provisions of the "Machinery" Directive (Directive 2006 / 42 / EC) and the regulations transposing into national law

### **NOTE**

This declaration becomes invalid if technical or operational modifications are introduced without the manufacturer's consent.

---

**ERC**

**TOSHIBA CARRIER CORPORATION**

336 TADEHARA, FUJI-SHI, SHIZUOKA-KEN 416-8521 JAPAN

**EH99960301-1**