

Toshiba Air Conditioning - RAS Data Sheet

RAS-18J2KVG-E
Seiya High-Wall Inverter

SEIYA



Features

- Designed for use with refrigerant R32
- A new design that improves the energy efficiency of entry-tier level to A++/A+
- Extremely quiet operation down to as low as 19 dB(A)
- New high-wall with dustless heat exchanger for improved efficiency
- High-power, self-cleaning, ECO, off timer, swing and heating only compatibility
- Extra features with the optional controller: power select, comfort sleep, on-off timer, 8°C and weekly timer

Technical Data

Model reference indoor unit		RAS-18J2KVG-E
Nominal cooling	kW	5.0
Nominal heating	kW	5.4
UK cooling	kW	4.88
UK sensible cooling	kW	3.57
UK heating	kW	3.34
Sound pressure (high/low)	dB(A)	48/32
Air flow (high/low)	m ³ /h	840/480
Dimensions (H x W x D)	mm	293 x 798 x 230
Unit weight	kg	9
Model reference outdoor unit		RAS-18J2AVG-E
Maximum running current	A	7.50
Suggested fuse size	A	16
Power supply	V-ph-Hz	220/240-1-50
Interconnecting cable		3-core + earth
Sound pressure (cool/heat)	dB(A)	50/52
Air flow (high)	m ³ /h	2160
Dimensions (H x W x D)	mm	550 x 780 x 290
Unit weight	kg	34
Pipe sizes (liquid-suction)	inch	1/4-1/2
Maximum pipe length/height difference	m	20/12
Pre-charge pipe length	m	15
Factory charge	kg	0.88
EER/COP		3.23/3.38
SEER/SCOP		6.30/4.00

Dimensional Drawings

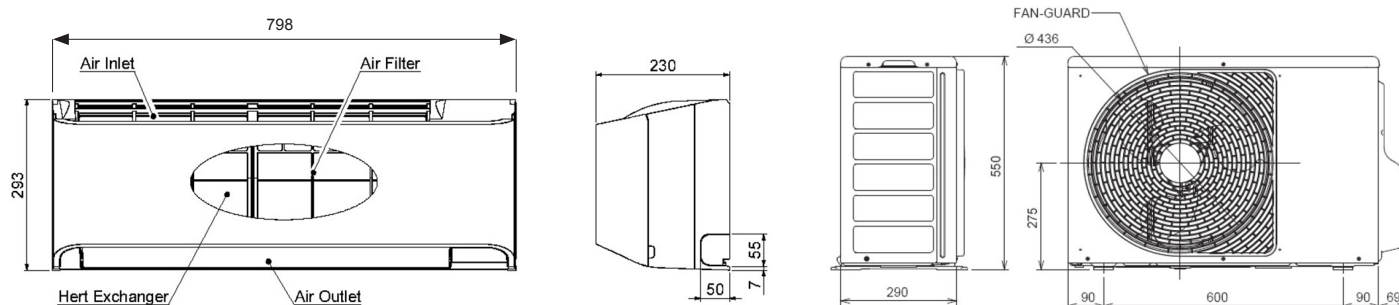

Cool Designs Ltd

Raising the Standards in Air Conditioning Distribution

www.cdlweb.info

