

## Toshiba Air Conditioning - RAV-GM Data Sheet

### RAV-GM561ATP-E Outdoor Unit

#### Features

- Redesigned for use with refrigerant R32
- Wide operating range (cooling mode -15°C to +46°C)
- Auto-diagnostic function
- Flexible, can be utilised for single, twin, triple indoor applications
- Compact size



#### Technical Data

Model reference			RAV-GM561ATP-E
Nominal	Cooling Capacity	kW	5.0
	Heating Capacity	kW	5.3
Operating Range	Cooling/Heating	°C	-15 to 46/-15 to 15
Air Flow	High	m <sup>3</sup> /h - l/s	2400 - 667
Sound	Pressure High Cooling/Heating	dB(A)	46/48
	Power High Cooling/Heating	dB(A)	63/65
Unit	Height x Width x Depth	mm	550 x 780 x 290
	Weight	kg	40
Pipe Connection	Flare Connections (gas - liquid)	inch	1/2 - 1/4
	Min.-Max. Length	m	5-30
	Maximum Height Difference	m	±10
	Drain Port Connection	mm	16
Refrigerant R32	Base Charge/Chargeless Length	kg/m	0.9/20
	Additional Charge Liquid Side	g/m	20
Run Current	Maximum	A	7.78
Power Cable	Outdoor to Indoor		3 core + earth
Power Supply	Suggested Fuse Size	V/ph/Hz-A	220-240/1/50-16

#### Dimensional Drawings

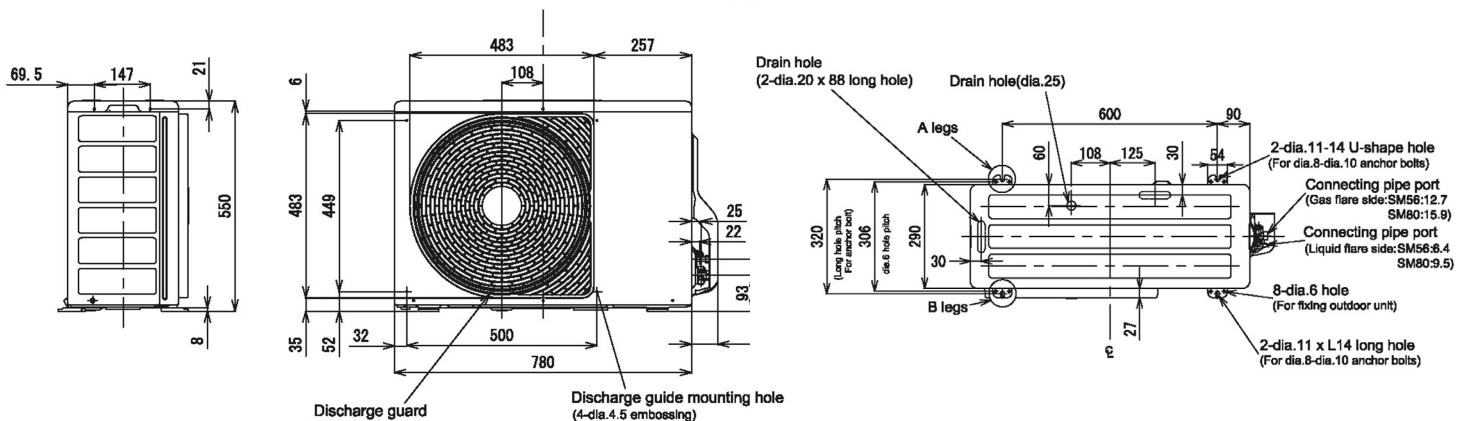

Cool Designs Ltd

Raising the Standards in Air Conditioning Distribution

www.cdlweb.info

