

Toshiba Air Conditioning - RAV-GM Data Sheet

RAV-GM401ATP-E Outdoor Unit

Features

- Redesigned for use with refrigerant R32
- Wide operating range (cooling mode -15°C to +46°C)
- Auto-diagnostic function
- Flexible, can be utilised for single, twin, triple indoor applications
- Compact size



Technical Data

Model reference		RAV-GM401ATP-E	
Nominal	Cooling Capacity	kW	3.6
	Heating Capacity	kW	4.0
Operating Range	Cooling/Heating	°C	-15 to 46/-15 to 15
Air Flow	High	m ³ /h - l/s	2200 - 612
Sound	Pressure High Cooling/Heating	dB(A)	49/50
	Power High Cooling/Heating	dB(A)	64/65
Unit	Height x Width x Depth	mm	550 x 780 x 290
	Weight	kg	34
Pipe Connection	Flare Connections (gas - liquid)	inch	1/2 - 1/4
	Min. -Max. Length	m	2-20
	Maximum Height Difference	m	±10
	Drain Port Connection	mm	16
Refrigerant R32	Base Charge/Chargeless Length	kg/m	0.9/15
	Additional Charge Liquid Side	g/m	20
Run Current	Maximum	A	5.60
Power Cable	Outdoor to Indoor		3 core + earth
Power Supply	Suggested Fuse Size	V/ph/Hz-A	220-240/1/50-10

Dimensional Drawings

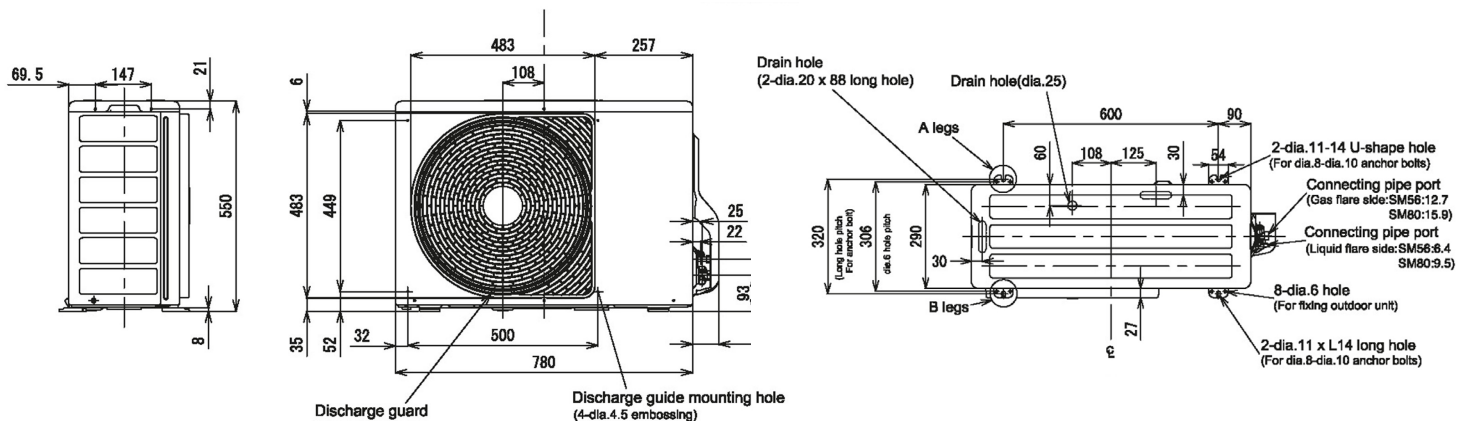

Cool Designs Ltd

Raising the Standards in Air Conditioning Distribution

www.cdlweb.info

