

## Toshiba Air Conditioning - RAS Data Sheet

### RAS-10PKVPG-E Daiseikai High-Wall Inverter

#### Features

- Designed for use with refrigerant R32
- Class-leading energy saving
- Extremely low sound levels
- Plasma air purifier
- Power change button to reduce power consumption by up to 50%
- Self-cleaning function



#### Technical Data

Model reference indoor unit		RAS-10PKVPG-E
Nominal cooling	kW	2.50
Nominal heating	kW	3.20
UK cooling	kW	2.44
UK sensible cooling	kW	2.03
UK heating	kW	1.90
Air flow (high/low)	m <sup>3</sup> /h	720/300
Sound pressure (high/low)	dB(A)	44/20
Dimensions (H x W x D)	mm	293 x 851 x 270
Unit weight	kg	14
Model reference outdoor unit		RAS-10PAVPG-E
Maximum run current	A	3.40
Suggested fuse size	A	10
Power supply	V-ph-Hz	220/240-1-50
Interconnecting cable		3-core + earth
Sound pressure (cool/heat)	dB(A)	46/47
Air flow (high)	m <sup>3</sup> /h	2160
Dimensions (H x W x D)	mm	630 x 800 x 300
Unit weight	kg	38
Pipe sizes (liquid-suction)	inch	1/4-3/8
Maximum pipe length/height difference	m	25/10
Pre-charge pipe length	m	15
Additional refrigerant - factory charge	g/m - kg	20 - 1.0
EER/COP		5.56/5.33
SEER/SCOP		10.60/5.20

#### Dimensional Drawings

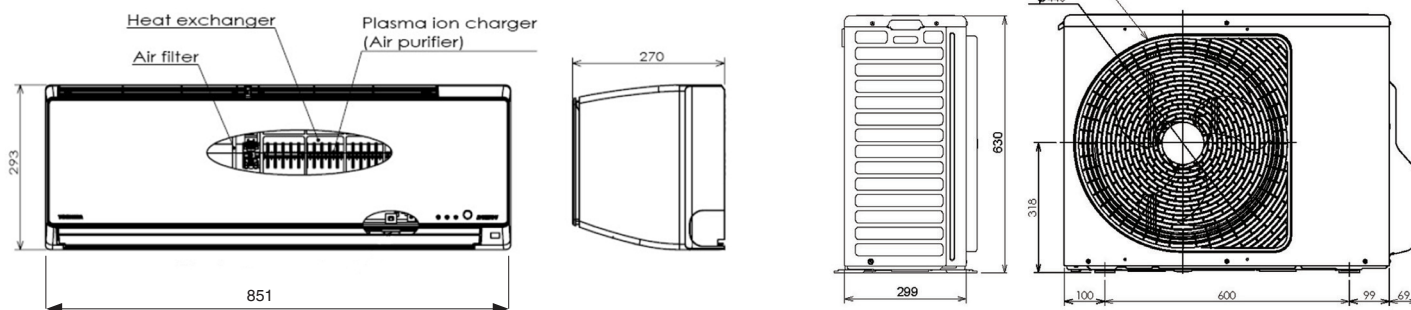

Cool Designs Ltd

Raising the Standards in Air Conditioning Distribution

www.cdlweb.info

