



CIAT - STELLA High-wall air conditioner

STELLA 9HV High-wall air conditioner

Features

- Infra-red controller as standard (wired available).
- Full Wi-Fi compatibility.
- Self-clean operation and built-in Ioniser.
- Louvre position memory.
- Drain port on both sides for easy installation.
- Refrigerant leakage detection display.



Technical Data

Model reference			STELLA - High-wall 9HV
Indoor unit			42HV09VSC
Outdoor unit			38HV09VSC
Cooling capacity	Min./nom./max.	kW	0.50/2.70/3.50
Heating capacity*	Min./nom./max.	kW	0.60/2.90/4.00
	@ -7 °C	kW	2.70
	@ -10 °C	kW	2.50
	@ -15 °C	kW	2.20
SEER		W/W	7.4
SCOP	Warmer/average	W/W	5.4/4.0
Energy label	SEER		A++
	SCOP warmer/average		A+++ / A+
Rated current		A	10.0
Rated input		kW	2.20
Power supply		V/ph/Hz	220-240/1/50
Power to			Outdoor
Interconnecting			5
Refrigerant amount	R410A	kg	0.72
Liquid side - gas side		inch	1/4 - 3/8
Standard piping length	Min./max. piping length	m	3/25
	Max. height difference	m	10
	Additional charge	g/m	15
Indoor unit			42HV09VSC
Sound power level**		dB(A)	53
Sound pressure level**	High/med./low/silence	dB(A)	38/34/30/21
Air flow	High/med./low/silence	m ³ /h	460/380/280/190
Weight		kg	8.0
Dimension	W x D x H	mm	730 x 192 x 291

* -7 °C/-10 °C/-15 °C heating at free frequency

** Sound data in cooling mode

Dimensional Drawings

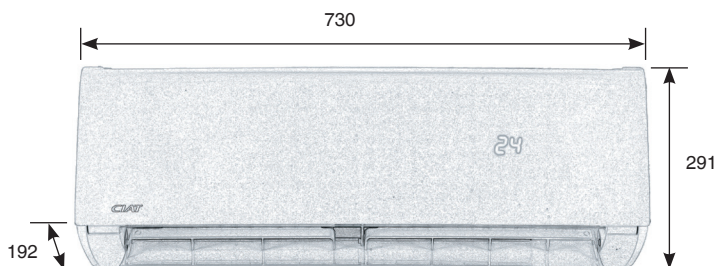

Cool Designs Ltd

Raising the Standards in Air Conditioning Distribution

www.cdlweb.info





CIAT - STELLA High-wall air conditioner

STELLA 9HV
High-wall air conditioner



Outdoor unit			38HV09VSC
Sound power level**		dB(A)	63
Sound pressure level**		dB(A)	54
Air flow		m ³ /h	1900
Weight		kg	26.5
Dimension	W x D x H	mm	770 x 300 x 555

** Sound data in cooling mode

Dimensional Drawings

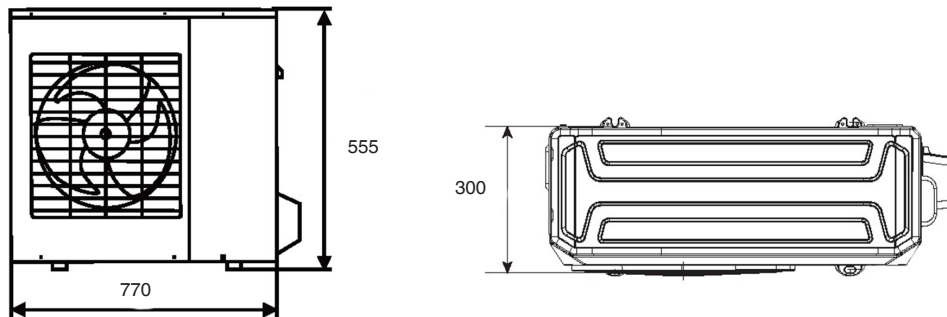

Accessories

Description	Part Number
Wired remote control for high-wall range - KJR-12- G1	7511629
Wi-Fi USB for hung wall range - WIFI USB	7511628

Split-system unit ratings are based on the following conditions:

Cooling capacities: Indoor air temperature 27°C (DB)/19°C (WB) - Outdoor air temperature 35°C (DB)/24°C (WB)

Heating capacities: Indoor air temperature 20°C (DB)/15°C (WB) - Outdoor air temperature 7°C (DB)/6°C (WB)

Cool Designs Ltd

Raising the Standards in Air Conditioning Distribution

www.cdlweb.info

