

## Toshiba Air Conditioning - RAV-SP Data Sheet

### RAV-SP404AT-E Outdoor Unit

#### Features

- R22 and R407C replacement technology
- Wide operating range (cooling mode -15°C to +43°C)
- Extended pipe runs up to 75 m (1104/1404)
- Flexible, can be utilised for single, twin, triple indoor applications
- Increased energy efficiency/cost saving



#### Technical Data

Model reference		RAV-SP404AT-E
Nominal cooling	kW	3.6
Nominal heating	kW	4.0
Standard air flow	m <sup>3</sup> /h	2400
Standard air flow	l/s	667
Sound power (cool/heat)	dB(A)	62/64
Sound pressure (cool/heat)	dB(A)	45/47
Dimensions (H x W x D)	mm	550 x 780 x 290
Unit weight	kg	40
Power supply	V-ph-Hz	220/240-1-50
Interconnecting cable		3 core + earth
Suggested fuse size	A	10
Maximum operating current (cooling)	A	5.2
Operating range, cooling	°C	-15 to 43
Operating range, heating	°C	-15 to 15
Pipe sizes (liquid-suction)	inch	1/4-1/2
Minimum/maximum pipe length	m	5/30
Maximum height difference	m	30
Pre-charge pipe length	m	20
Additional R410A refrigerant - factory charge	g/m - kg	20 - 1.0

#### Dimensional Drawings

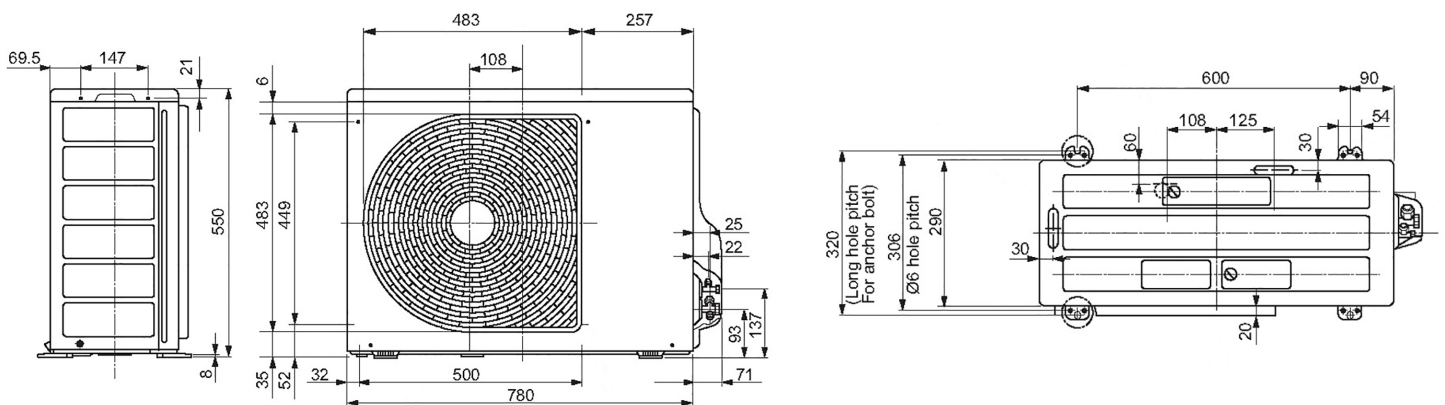

Cool Designs Ltd

Raising the Standards in Air Conditioning Distribution

www.cdlweb.info

