

Toshiba Air Conditioning - RAV-SP Data Sheet

RAV-SP1604AT8-E Outdoor Unit

Features

- R22 and R407C replacement technology
- Wide operating range (cooling mode -15°C to +46°C)
- Extended pipe runs up to 75 m (1104/1404)
- Flexible, can be utilised for single, twin, triple indoor applications
- Increased energy efficiency/cost saving



Technical Data

Model reference		RAV-SP1604AT8-E
Nominal cooling	kW	14.0
Nominal heating	kW	16.0
Standard air flow	m ³ /h	6180
Standard air flow	l/s	1717
Sound power (cool/heat)	dB(A)	68/70
Sound pressure (cool/heat)	dB(A)	51/53
Dimensions (H x W x D)	mm	1340 x 900 x 320
Unit weight	kg	95
Power supply	V-ph-Hz	380/415-3-50
Interconnecting cable		3 core + earth
Suggested fuse size	A	16
Maximum operating current (cooling)	A	7.55
Operating range, cooling	°C	-15 to 46
Operating range, heating	°C	-20 to 15
Pipe sizes (liquid-suction)	inch	3/8-5/8
Minimum/maximum pipe length	m	3/75
Maximum height difference	m	30
Pre-charge pipe length	m	30
Additional R410A refrigerant - factory charge	g/m - kg	40 - 3.1

Dimensional Drawings

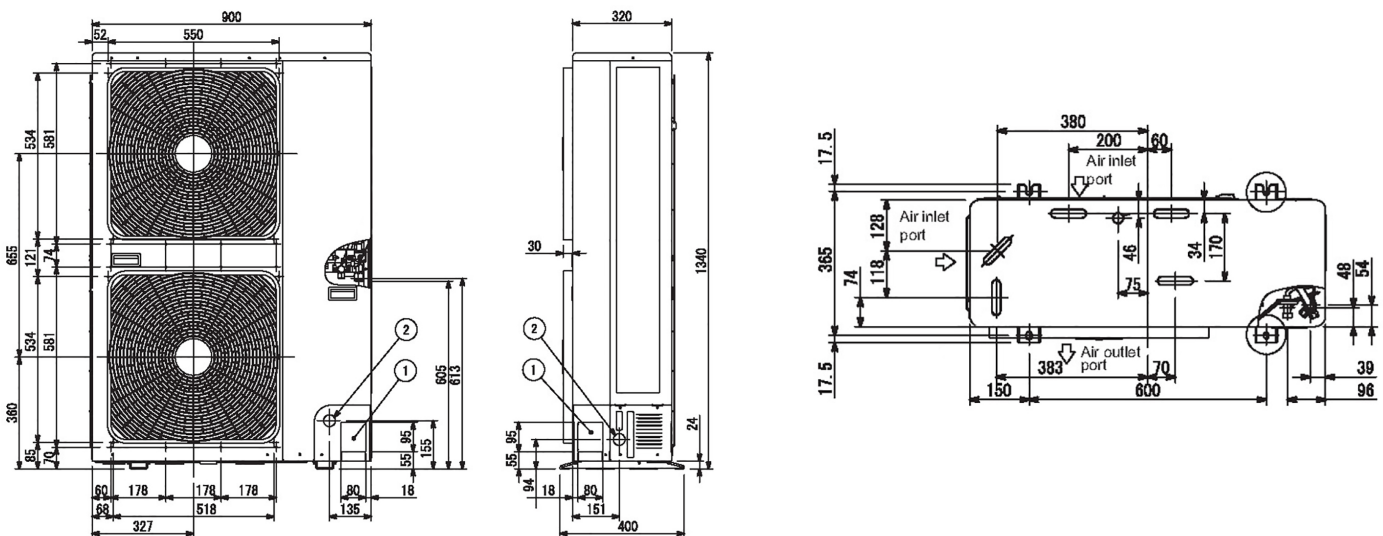

Cool Designs Ltd

Raising the Standards in Air Conditioning Distribution

www.cdlweb.info

