

Toshiba Air Conditioning - RAV-SM Data Sheet

RAV-SM1104ATP-E Outdoor Unit

Features

- R22 and R407C replacement technology
- Wide operating range (cooling mode -15°C to +46°C)
- Auto-diagnostic function
- Flexible, can be utilised for single, twin, triple indoor applications
- Compact size



Technical Data

Model reference		RAV-SM1104ATP-E
Nominal cooling	kW	10.0
Nominal heating	kW	11.2
Standard air flow	m ³ /h	4080
Standard air flow	l/s	1133
Sound power (cool/heat)	dB(A)	70/71
Sound pressure (cool/heat)	dB(A)	53/54
Dimensions (H x W x D)	mm	890 x 900 x 320
Unit weight	kg	68
Power supply	V-ph-Hz	220/240-1-50/60
Interconnecting cable		3 core + earth
Suggested fuse size	A	20
Maximum operating current (cooling)	A	15.04
Operating range, cooling	°C	-15 to 46
Operating range, heating	°C	-15 to 15
Pipe sizes (liquid-suction)	inch	3/8-5/8
Minimum/maximum pipe length	m	5/50
Maximum height difference	m	30
Pre-charge pipe length	m	30
Additional R410A refrigerant - factory charge	g/m - kg	40 - 2.8

Dimensional Drawings

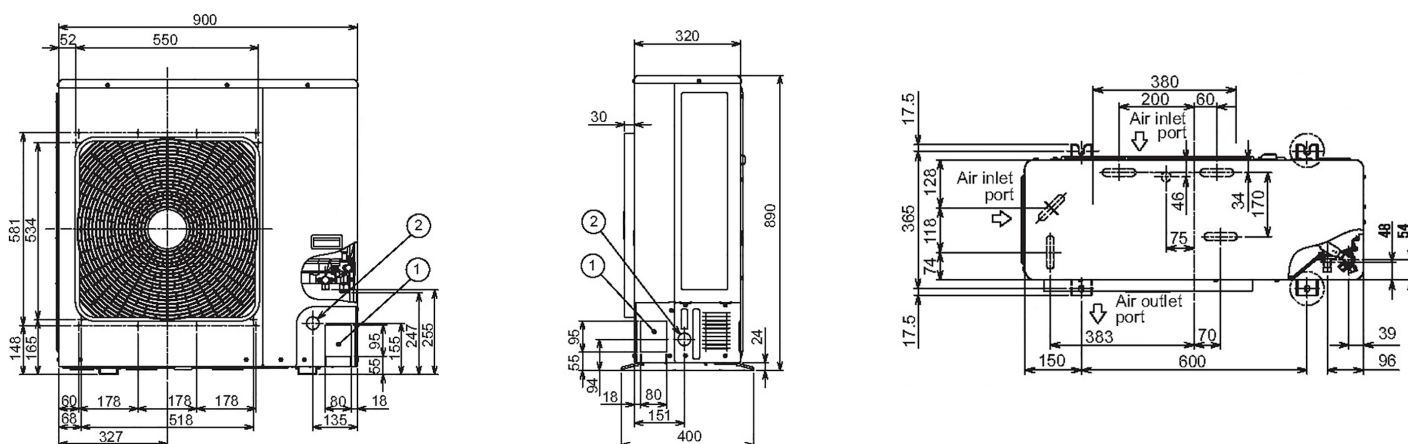

Cool Designs Ltd

Raising the Standards in Air Conditioning Distribution

www.cdlweb.info

