

Toshiba Air Conditioning - VRF Data Sheet

MML-AP0244H-E Floor-mounted console

Features

- Vertical or horizontal air discharge
- Built-in facility for standard remote controller
- Variable installation options, service access at top, rear, left or right side of unit
- Minimum space required for installation and servicing



Technical Data

Model reference		MML-AP0244H-E
Nominal cooling	kW	7.1
Nominal heating	kW	8.0
Capacity code		2.5
Power input (cool/heat)	kW	0.10
UK cooling	kW	6.82
UK sensible cooling	kW	5.12
UK heating	kW	6.48
Starting current	A	1.10
Running current	A	0.47
Suggested fuse size	A	5
Power supply	V-ph-Hz	220/240-1-50
Interconnecting cable		2-core screened 1.5 mm
Sound power H-M-L	dB(A)	62-57-52
Sound pressure H-L	dB(A)	49-39
Air flow H-L	m ³ /h	1080-780
Air flow H-L	l/s	299-216
Dimensions (H x W x D)	mm	630 x 950 x 230
Unit weight	kg	40

Dimensional Drawings

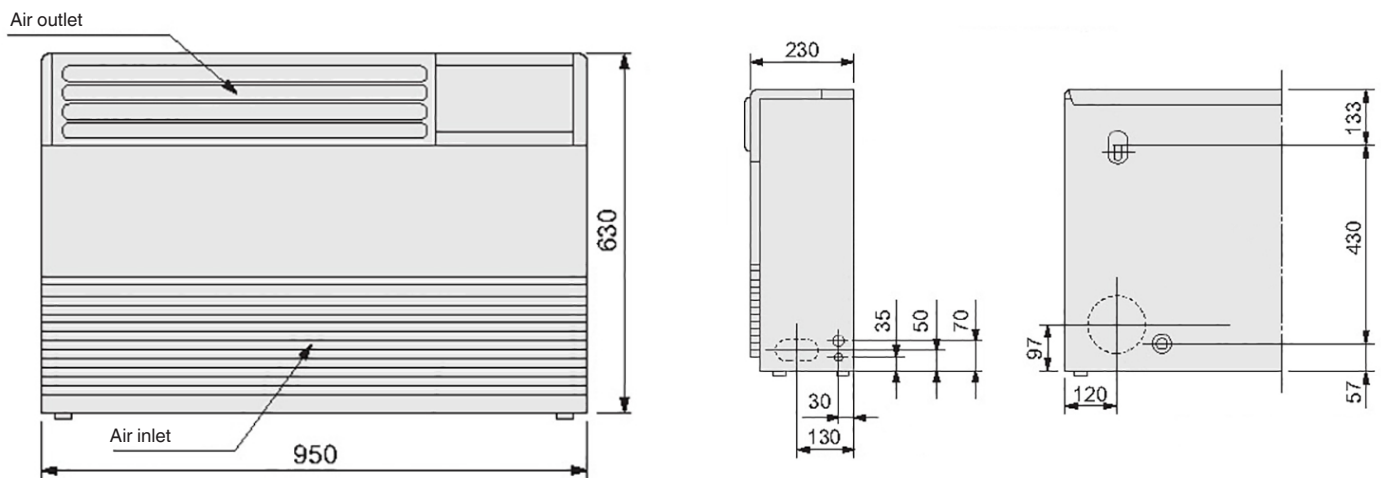

Cool Designs Ltd

Raising the Standards in Air Conditioning Distribution

www.cdlweb.info

