

## Toshiba Air Conditioning - VRF Data Sheet

### MML-AP0124H-E Floor-mounted console

#### Features

- Vertical or horizontal air discharge
- Built-in facility for standard remote controller
- Variable installation options, service access at top, rear, left or right side of unit
- Minimum space required for installation and servicing



#### Technical Data

Model reference		MML-AP0124H-E
Nominal cooling	kW	3.6
Nominal heating	kW	4.0
Capacity code		1.25
Power input (cool/heat)	kW	0.092
UK cooling	kW	3.46
UK sensible cooling	kW	2.60
UK heating	kW	3.24
Starting current	A	0.80
Running current	A	0.43
Suggested fuse size	A	5
Power supply	V-ph-Hz	220/240-1-50
Interconnecting cable		2-core screened 1.5 mm
Sound power H-M-L	dB(A)	60-56-53
Sound pressure H-L	dB(A)	45-38
Air flow H-L	m <sup>3</sup> /h	900-650
Air flow H-L	l/s	250-17
Dimensions (H x W x D)	mm	630 x 950 x 230
Unit weight	kg	37

#### Dimensional Drawings

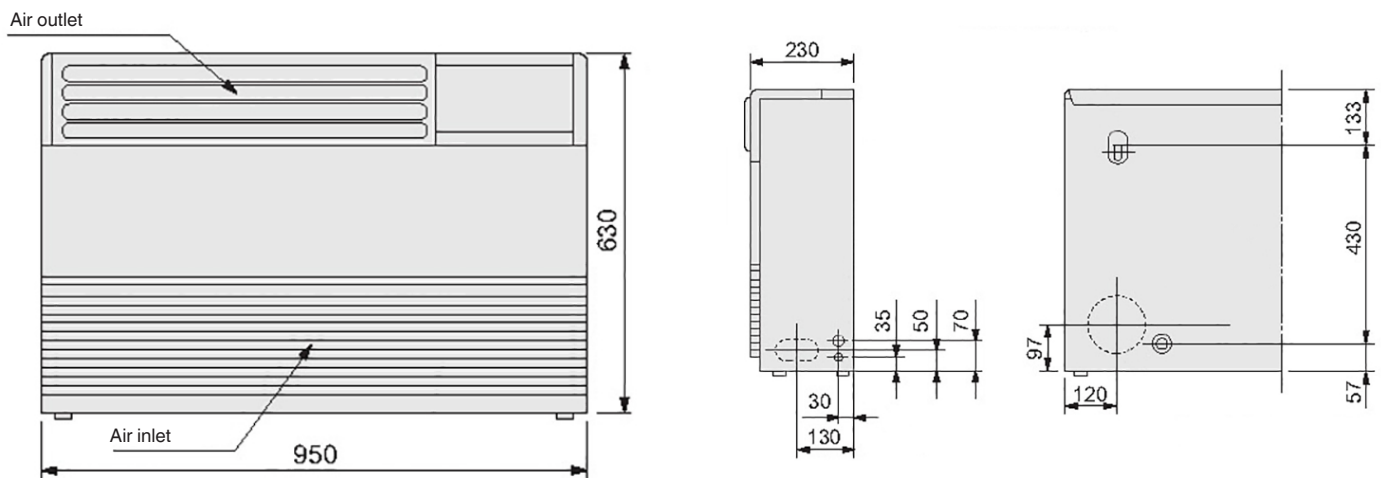

Cool Designs Ltd

Raising the Standards in Air Conditioning Distribution

www.cdlweb.info

