

Toshiba Air Conditioning - VRF Data Sheet

MML-AP0094H-E Floor-mounted console

Features

- Vertical or horizontal air discharge
- Built-in facility for standard remote controller
- Variable installation options, service access at top, rear, left or right side of unit
- Minimum space required for installation and servicing



Technical Data

Model reference		MML-AP0094H-E
Nominal cooling	kW	2.8
Nominal heating	kW	3.2
Capacity code		1.0
Power input (cool/heat)	kW	0.056
UK cooling	kW	2.69
UK sensible cooling	kW	2.02
UK heating	kW	2.59
Starting current	A	0.60
Running current	A	0.26
Suggested fuse size	A	5
Power supply	V-ph-Hz	220/240-1-50
Interconnecting cable		2-core screened 1.5 mm
Sound power H-M-L	dB(A)	54-52-50
Sound pressure H-L	dB(A)	39-35
Air flow H-L	m ³ /h	480-360
Air flow H-L	l/s	133-100
Dimensions (H x W x D)	mm	630 x 950 x 230
Unit weight	kg	37

Dimensional Drawings

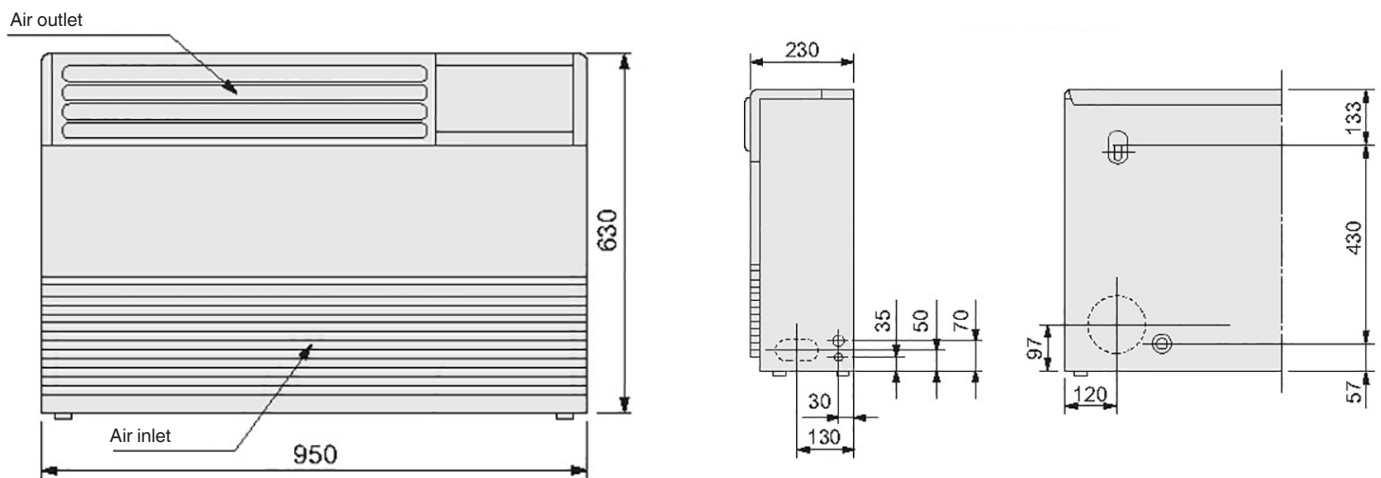

Cool Designs Ltd

Raising the Standards in Air Conditioning Distribution

www.cdlweb.info

