

Toshiba Air Conditioning - VRF Data Sheet

MMK-AP0243H High-Wall

Features

- Compact and lightweight 15 kg
- Outstanding sound levels down to 28 dB(A)
- Automatic louvre swing pattern to distribute the air evenly into the room
- Infra-red or hard-wired remote controller option



Technical Data

Model reference		MMK-AP0243H
Nominal cooling	kW	7.1
Nominal heating	kW	8.0
Capacity code		2.5
Power input (cool/heat)	kW	0.050
UK cooling	kW	6.82
UK sensible cooling	kW	5.12
UK heating	kW	6.48
Starting current	A	0.47
Running current	A	0.37
Suggested fuse size	A	5
Power supply	V-ph-Hz	220/240-1-50
Interconnecting cable		2-core screened 1.5 mm
Sound power H-M-L	dB(A)	61-54-49
Sound pressure H-L	dB(A)	46-34
Air flow H-L	m ³ /h	1020-570
Air flow H-L	l/s	283-167
Dimensions (H x W x D)	mm	320 x 1050 x 228
Unit weight	kg	15

Dimensional Drawings

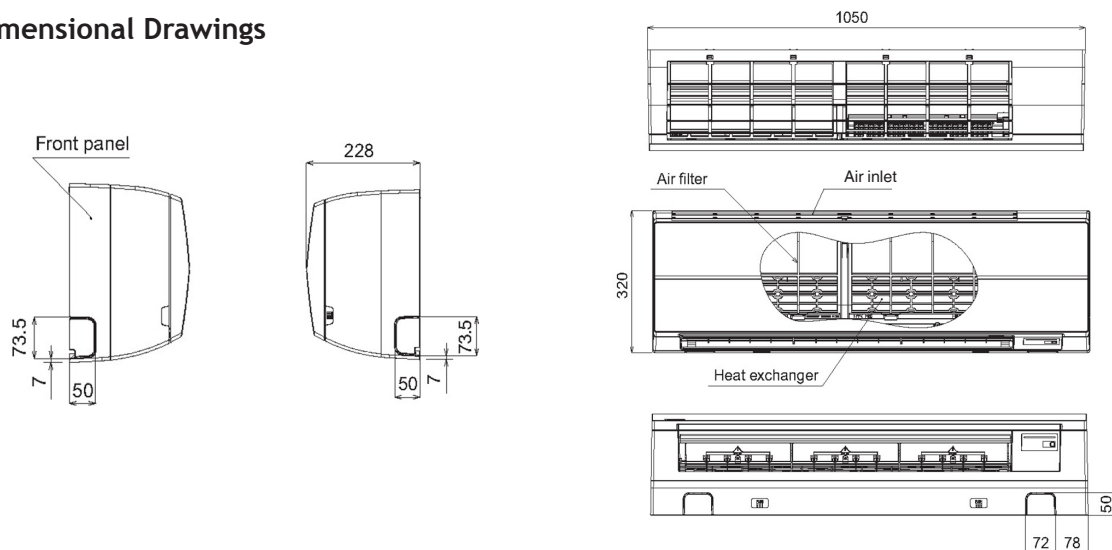

Cool Designs Ltd

Raising the Standards in Air Conditioning Distribution

www.cdlweb.info

