

Toshiba Air Conditioning - VRF Data Sheet

MMK-AP0153H High-Wall

Features

- Compact and lightweight 15 kg
- Outstanding sound levels down to 28 dB(A)
- Automatic louvre swing pattern to distribute the air evenly into the room
- Infra-red or hard-wired remote controller option



Technical Data

| Model reference | | MMK-AP0153H |
|-------------------------|-------------------|------------------------|
| Nominal cooling | kW | 4.5 |
| Nominal heating | kW | 5.0 |
| Capacity code | | 1.7 |
| Power input (cool/heat) | kW | 0.043 |
| UK cooling | kW | 4.33 |
| UK sensible cooling | kW | 3.24 |
| UK heating | kW | 4.05 |
| Starting current | A | 0.41 |
| Running current | A | 0.32 |
| Suggested fuse size | A | 5 |
| Power supply | V-ph-Hz | 220/240-1-50 |
| Interconnecting cable | | 2-core screened 1.5 mm |
| Sound power H-M-L | dB(A) | 56-51-48 |
| Sound pressure H-L | dB(A) | 41-33 |
| Air flow H-L | m ³ /h | 840-540 |
| Air flow H-L | l/s | 233-150 |
| Dimensions (H x W x D) | mm | 320 x 1050 x 228 |
| Unit weight | kg | 15 |

Dimensional Drawings

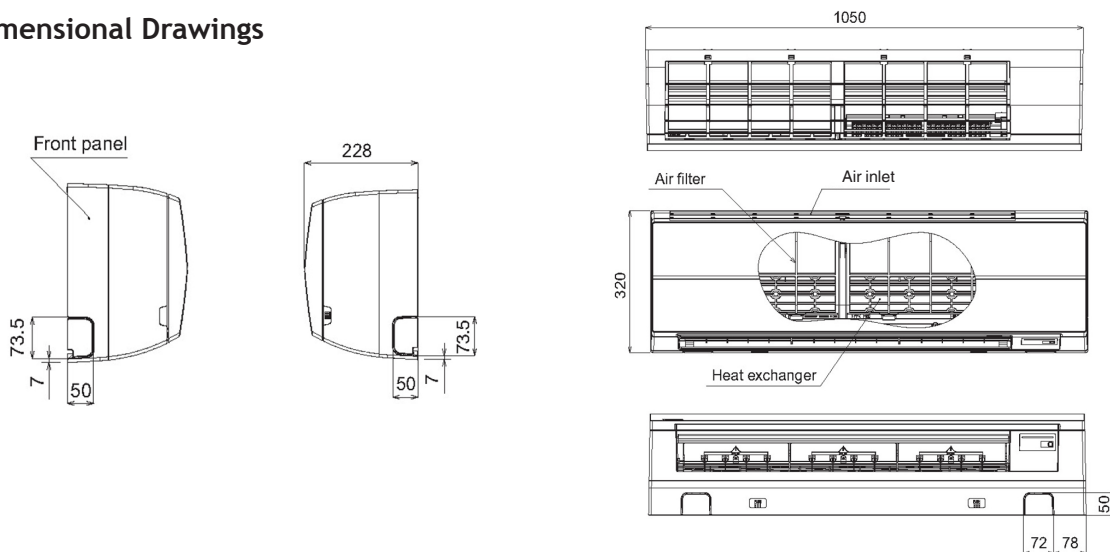

Cool Designs Ltd

Raising the Standards in Air Conditioning Distribution

www.cdlweb.info

