

Toshiba Air Conditioning - VRF Data Sheet

MMK-AP0094MH-E High-Wall

Features

- Compact and lightweight 11 kg
- Outstanding sound levels down to 29 dB(A)
- Automatic louvre swing pattern to distribute the air evenly into the room
- Infra-red or hard-wired remote controller option



Technical Data

Model reference		MMK-AP0094MH-E
Nominal cooling	kW	2.8
Nominal heating	kW	3.2
Capacity code		1.0
Power input (cool/heat)	kW	0.018
UK cooling	kW	2.69
UK sensible cooling	kW	2.02
UK heating	kW	2.59
Starting current	A	0.23
Running current	A	0.18
Suggested fuse size	A	5
Power supply	V-ph-Hz	220/240-1-50
Interconnecting cable		2-core screened 1.5 mm
Sound power H-M-L	dB(A)	51-48-44
Sound pressure H-L	dB(A)	36-29
Air flow H-L	m ³ /h	510-360
Air flow H-L	l/s	150-100
Dimensions (H x W x D)	mm	275 x 790 x 208
Unit weight	kg	11

Dimensional Drawings

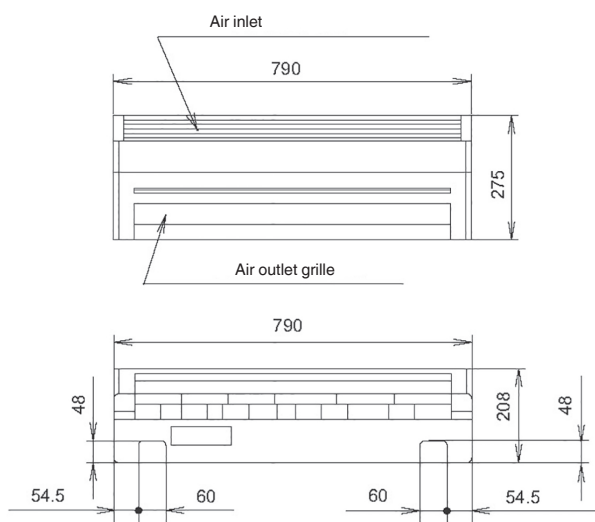
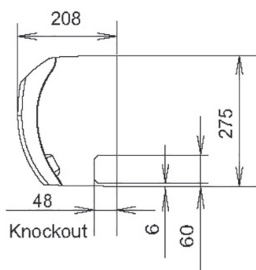
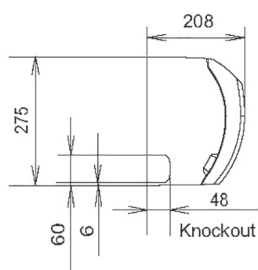

Cool Designs Ltd

Raising the Standards in Air Conditioning Distribution

www.cdlweb.info

