

Toshiba Air Conditioning - VRF Data Sheet

MMF-AP0246H-E Floor-mounted cabinet

Features

- Wide automatic vertical and horizontal air distribution with an angle up to 150°
- Large capacity range: cooling capacities from 4.5 kW to 16 kW, heating capacities from 5 kW to 18 kW
- Very small footprint 0.128 m² up to 8 kW and 0.243 m² up to 16 kW
- High air flows from 660 m³/h to 2160 m³/h



Technical Data

Model reference		MMF-AP0246H-E
Nominal cooling	kW	7.1
Nominal heating	kW	8.0
Capacity code		2.5
Power input (cool/heat)	kW	0.089
UK cooling	kW	6.4
UK sensible cooling	kW	5.0
UK heating	kW	6.2
Starting current	A	0.84
Running current	A	0.60
Suggested fuse size	A	5
Power supply	V-ph-Hz	220/240-1-50
Interconnecting cable		2-core screened 1.5 mm
Sound power H-M-L	dB(A)	62-58-53
Sound pressure H-L	dB(A)	49-39
Air flow H-L	m ³ /h	1200-840
Air flow H-L	l/s	332-233
Dimensions (H x W x D)	mm	1750 x 600 x 210
Unit weight	kg	47

Dimensional Drawings

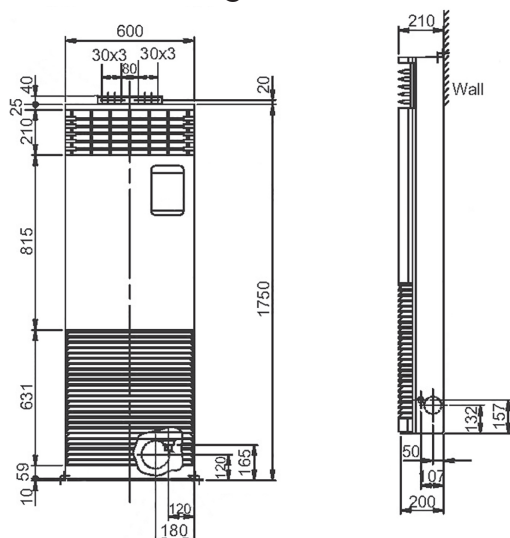

Cool Designs Ltd

Raising the Standards in Air Conditioning Distribution

www.cdlweb.info

