

Toshiba Air Conditioning - VRF Data Sheet

MMD-AP0246BHP-E Standard ducted

Features

- External static pressure can be raised up to 120 Pa
- Low noise: low fan speed down to 27 dB(A)
- Fresh air intake
- Lift pump up to 850 mm lift
- Ideal for restricted ceiling voids only 275 mm high
- Base or rear return air



Technical Data

Model reference		MMD-AP0246BHP-E
Nominal cooling	kW	7.1
Nominal heating	kW	8.0
Capacity code		2.5
Power input (cool/heat)	kW	0.077
UK cooling	kW	6.82
UK sensible cooling	kW	5.12
UK heating	kW	6.48
Starting current	A	0.90
Running current	A	0.52
Suggested fuse size	A	5
Power supply	V-ph-Hz	220/240-1-50
Interconnecting cable		2-core screened 1.5 mm
Sound power H-M-L	dB(A)	51-46-42
Sound pressure H-L	dB(A)	36-27
Standard air flow H-L	m ³ /h	1200-870
Standard air flow H-L	l/s	333-242
External static pressure (factory default)	Pa	40
Static pressure range	Pa	30-120
Dimensions (H x W x D)	mm	275 x 1000 x 750
Unit weight	kg	30

Dimensional Drawings

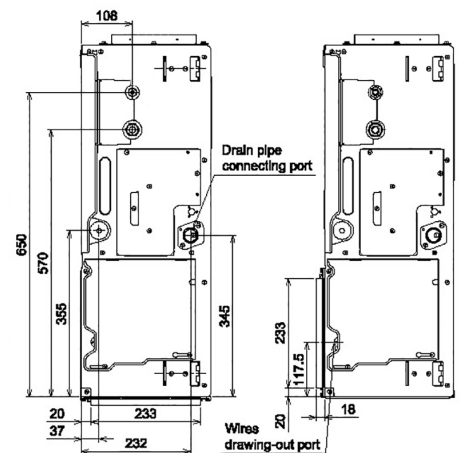
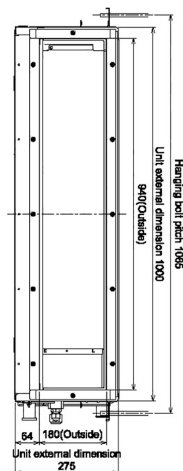
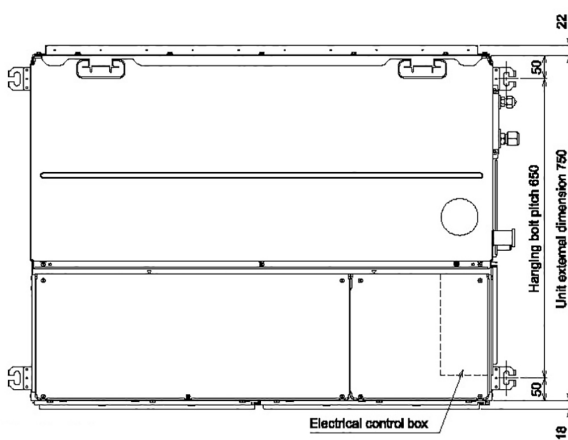

Cool Designs Ltd

Raising the Standards in Air Conditioning Distribution

www.cdlweb.info

