

Toshiba Air Conditioning - VRF Data Sheet

MMY-MAP2006FT8P

Three-pipe SHRMe - Super Heat Recovery Condensing Unit

Features

- Dual setpoint for more precision
- ESEER increased to > 8
- UK-SEER achievable to >10
- New 4 series flow box with 50 m run
- New 4- and 6-port multi-flow boxes



Technical Data

Model reference		MMY-MAP2006FT8P
Nominal cooling	kW	56.0
Nominal heating	kW	58.0
Capacity code		20
Min./max. capacities connectable	kW	44.8/75.6
Power input (cool/heat)	kW	18.6/15.9
SEER/ESEER Value (Office Profile)		6.65/7.11
SCOP/ESCOP Value (Office Profile)		4.50/4.70
Starting current	A	1
Running current (cool/heat)	A	29.18/24.68
Suggested fuse size	A	40
Power supply	V-ph-Hz	380/415-3-50
Interconnecting cable		2-core screened 1.5 mm
Sound power (cool/heat)	dB(A)	83/84
Sound pressure (cool/heat)	dB(A)	61/62
Standard air flow	m ³ /h	17300
Standard air flow	l/s	4806
External static pressure	Pa	40
Maximum indoor units connectable		41
Dimensions (H x W x D)	mm	1830 x 1600 x 780
Unit weight	kg	377
R410A refrigerant base charge	kg	11

Dimensional Drawings

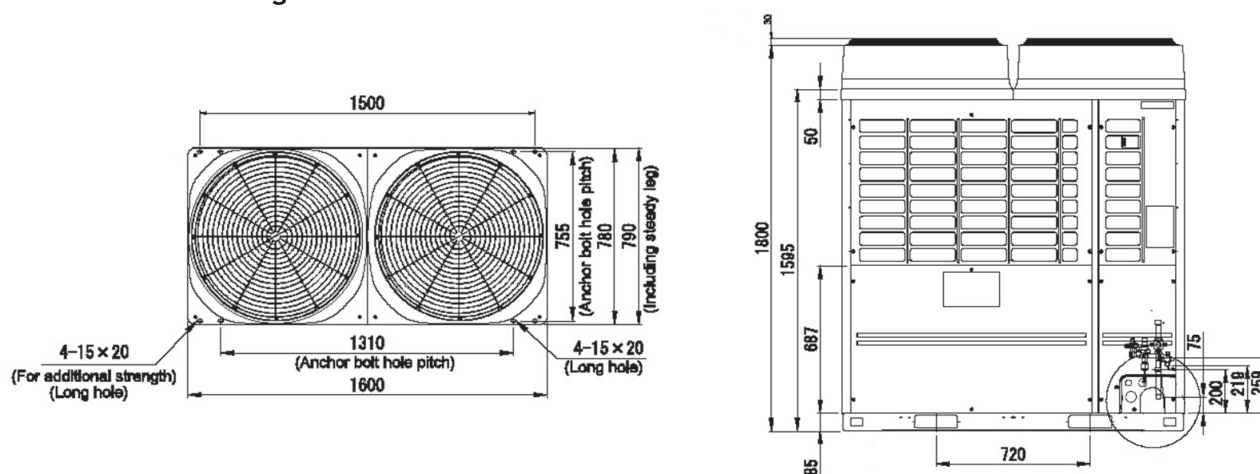

Cool Designs Ltd

Raising the Standards in Air Conditioning Distribution

www.cdlweb.info

