

Toshiba Air Conditioning - VRF Data Sheet

MMY-MAP1606FT8P

Three-pipe SHRMe - Super Heat Recovery Condensing Unit

Features

- Dual setpoint for more precision
- ESEER increased to > 8
- UK-SEER achievable to >10
- New 4 series flow box with 50 m run
- New 4- and 6-port multi-flow boxes



Technical Data

Model reference		MMY-MAP1606FT8P
Nominal cooling	kW	45.0
Nominal heating	kW	50.0
Capacity code		16
Min./max. capacities connectable	kW	36.00/60.75
Power input (cool/heat)	kW	13.9/12.2
SEER/ESEER Value (Office Profile)		7.62/8.17
SCOP/ESCOP Value (Office Profile)		4.62/4.82
Starting current	A	1
Running current (cool/heat)	A	21.81/19.14
Suggested fuse size	A	32
Power supply	V-ph-Hz	380/415-3-50
Interconnecting cable		2-core screened 1.5 mm
Sound power (cool/heat)	dB(A)	83/84
Sound pressure (cool/heat)	dB(A)	61/62
Standard air flow	m ³ /h	17300
Standard air flow	l/s	4806
External static pressure	Pa	40
Maximum indoor units connectable		36
Dimensions (H x W x D)	mm	1830 x 1600 x 780
Unit weight	kg	377
R410A refrigerant base charge	kg	11

Dimensional Drawings

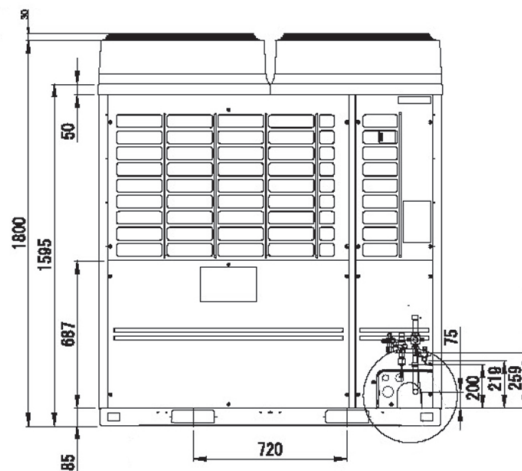
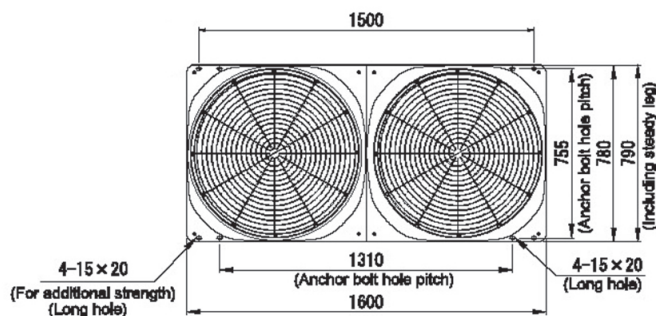

Cool Designs Ltd

Raising the Standards in Air Conditioning Distribution

www.cdlweb.info

