

AIRSTAGE™ Circular Flow Cassette

AUXK018/024/030/036/045/054GLAH

Comfort for large room

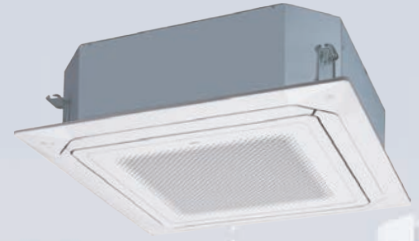

Circular flow

Point

Efficient air conditioning to the every corner of the room without drafts

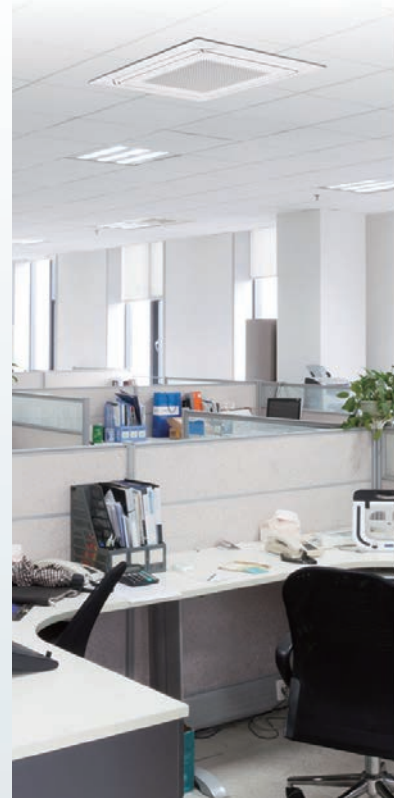
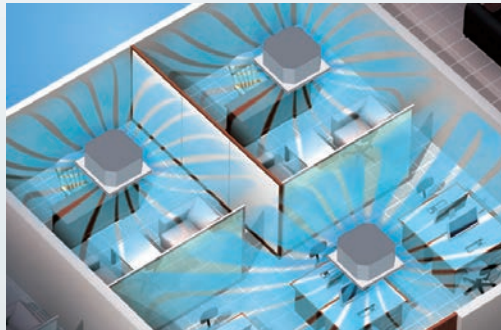

Individual louvre control

Point

Each louvre can be set individually by Controller* to enjoy the comfort of different directional airflows according to various room layouts.

*: Touch Panel Wired RC (UTY-RNRYZ1) / Touch Panel Controller (UTY-DTGYZ1) System Controller (UTY-APGXZ1) / System Controller Lite (UTY-ALGXZ1)



Comfortable air conditioning by preventing direct blowing of cold air and by providing swinging air flow simultaneously

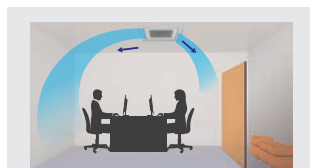

Efficient air conditioning in accordance with the room layout

Human Sensor for Energy saving (option)

Point

• Human sensor

2 modes can be selected.

Auto saving

Power is saved while no one is around

Auto OFF

Operation is stopped while no one is around

*Touch Panel Wired RC (UTY-RNRYZ2) only



Quiet operation & 6 Fan speed control

Drastic low noise is realised by new airflow structure. In addition, multistep quiet operation is available by 6-step sound level settings.

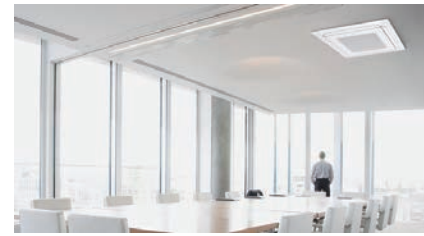
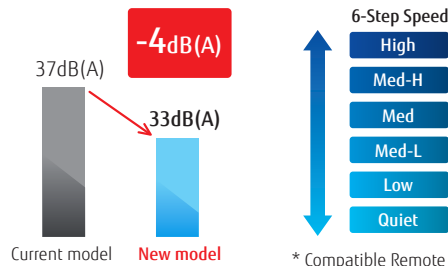

* Compatible Remote Controller is as follows:

Specifications

Model name		AUXK018GLAH	AUXK024GLAH	AUXK030GLAH	AUXK036GLAH	AUXK045GLAH	AUXK054GLAH
Power source		Single-phase, ~230V, 50Hz					
Capacity	UK Total Cooling	4.20	5.30	6.70	8.30	9.30	10.40
	UK Sensible Cooling	3.30	4.40	5.30	6.70	7.60	8.70
	UK Heating	5.90	7.40	9.30	11.60	13.00	14.90
	Nominal Cooling	5.60	7.10	9.00	11.20	12.50	14.00
	Nominal Heating	6.30	8.00	10.00	12.50	14.00	16.00
Input power	W	40	40	47	61	89	116
Airflow rate	High	1,420	1,420	1,440	1,620	1,820	2,040
	Med-H	1,360	1,360	1,440	1,500	1,590	1,800
	Med	1,300	1,300	1,340	1,400	1,500	1,590
	Med-L	1,270	1,270	1,300	1,340	1,400	1,440
	Low	1,200	1,200	1,280	1,280	1,300	1,300
	Quiet	1,150	1,150	1,150	1,150	1,150	1,150
Sound pressure level	High	38	38	39	41	44	47
	Med-H	37	37	38	40	42	45
	Med	36	36	37	38	40	42
	Med-L	35	35	36	37	38	39
	Low	34	34	35	36	36	36
	Quiet	33	33	33	33	33	33
Dimensions (H × W × D)	mm	288 × 840 × 840 (Grille 53 × 950 × 950)					
Weight	kg	26.5 (Grille 6.0)			29.5 (Grille 6.0)		
Connection pipe diameter	Liquid (Flare)				3/8		
	Gas (Flare)				5/8		
Cassette Grille	Model name	UTG-UKYC-W					

Note : Specifications are based on the following conditions.

Cooling : Indoor temperature of 27°CDB / 19°CWB, and outdoor temperature of 35°CDB / 24°CWB.

Heating : Indoor temperature of 20°CDB / (15°CWB), and outdoor temperature of 7°CDB / 6°CWB.

Pipe length : 7.5 m; Height difference between outdoor unit and indoor unit : 0 m. Voltage : 230 [V].

When AUX*018GLAH is connected to the outdoor unit other than J-III, pipe diameter should be 3/8 & 5/8 (Liq/Gas)

When AUXK036GLAH, AUXK045GLAH, and AUXK054GLAH are connected to the outdoor unit other than J-III, gas pipe diameter should be 3/4

Dimensions

Models: AUXK018GLAH / AUXK024GLAH / AUXK030GLAH / AUXK036GLAH / AUXK045GLAH / AUXK054GLAH

(Unit : mm)

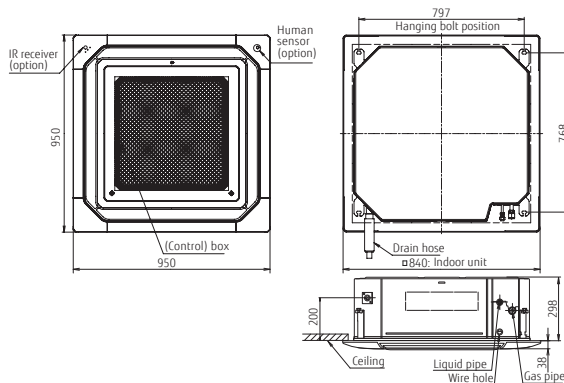

Optional parts

Wired Remote Controller: UTY-RNRY22

Wireless Remote Controller: UTY-LNHY

Simple Remote Controller: UTY-RSRY, UTY-RHRY

IR Receiver Unit: UTY-LBHxD

Human Sensor Kit: UTY-SHZXC

Flesh Air Intake Kit: UTZ-VXRA

• Specifications and design are subject to change without notice for further improvement.

• "AIRSTAGE" are worldwide trademarks of FUJITSU GENERAL LIMITED and are registered trademarks in Japan and other countries or areas.

• Other company and product names mentioned herein may be registered trademarks, trademarks or trade names of their respective owners.

• Actual products' colours may be different from the colours shown in this printed material.

Distributed by:

FUJITSU GENERAL AIR CONDITIONING (UK) LTD

Unit 150 Centennial Park, Centennial Avenue, Elstree, Herts. WD6 3SG

www.fujitsu-general.com/uk

Tel: +44 (0)208 731 3450 Fax: +44 (0)208 731 3451

Copyright© 2016 Fujitsu General Limited. All rights reserved. 6EFNP12-1612E