

TOSHIBA

Leading Innovation >>>

AIR CONDITIONER (SPLIT TYPE) Installation Manual



Indoor Unit

Model name:

Ceiling Type

RAV-SM567CTP-E

RAV-SM807CTP-E

RAV-SM1107CTP-E

RAV-SM1407CTP-E

RAV-SM1607CTP-E

For commercial use

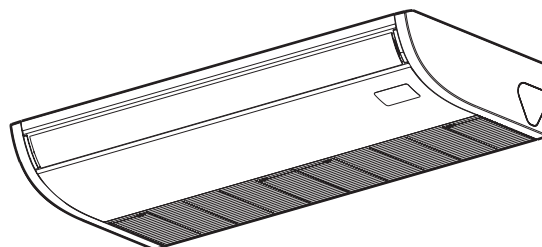

Original instruction

Please read this Installation Manual carefully before installing the Air Conditioner.

- This Manual describes the installation method of the indoor unit.
- For installation of the outdoor unit, follow the Installation Manual attached to the outdoor unit.

ADOPTION OF NEW REFRIGERANT

This Air Conditioner uses R410A an environmentally friendly refrigerant.

Contents

1	Precautions for safety	3
2	Accessory parts	5
3	Selection of installation place	5
4	Installation	6
5	Drain piping	9
6	Refrigerant piping	11
7	Electrical connection	12
8	Applicable controls	14
9	Test run	19
10	Maintenance	20
11	Troubleshooting	21

Thank you for purchasing this Toshiba air conditioner.

Please read carefully through these instructions that contain important information which complies with the "Machinery" Directive (Directive 2006/42/EC), and ensure that you understand them.

After completing the installation work, hand over this Installation Manual as well as the Owner's Manual provided to the user, and ask the user to keep them in a safe place for future reference.

Generic Denomination: Air Conditioner

Definition of Qualified Installer or Qualified Service Person

The air conditioner must be installed, maintained, repaired and removed by a qualified installer or qualified service person. When any of these jobs is to be done, ask a qualified installer or qualified service person to do them for you. A qualified installer or qualified service person is an agent who has the qualifications and knowledge described in the table below.

Agent	Qualifications and knowledge which the agent must have
Qualified installer	<ul style="list-style-type: none"> The qualified installer is a person who installs, maintains, relocates and removes the air conditioners made by Toshiba Carrier Corporation. He or she has been trained to install, maintain, relocate and remove the air conditioners made by Toshiba Carrier Corporation or, alternatively, he or she has been instructed in such operations by an individual or individuals who have been trained and is thus thoroughly acquainted with the knowledge related to these operations. The qualified installer who is allowed to do the electrical work involved in installation, relocation and removal has the qualifications pertaining to this electrical work as stipulated by the local laws and regulations, and he or she is a person who has been trained in matters relating to electrical work on the air conditioners made by Toshiba Carrier Corporation or, alternatively, he or she has been instructed in such matters by an individual or individuals who have been trained and is thus thoroughly acquainted with the knowledge related to this work. The qualified installer who is allowed to do the refrigerant handling and piping work involved in installation, relocation and removal has the qualifications pertaining to this refrigerant handling and piping work as stipulated by the local laws and regulations, and he or she is a person who has been trained in matters relating to refrigerant handling and piping work on the air conditioners made by Toshiba Carrier Corporation or, alternatively, he or she has been instructed in such matters by an individual or individuals who have been trained and is thus thoroughly acquainted with the knowledge related to this work. The qualified installer who is allowed to work at heights has been trained in matters relating to working at heights with the air conditioners made by Toshiba Carrier Corporation or, alternatively, he or she has been instructed in such matters by an individual or individuals who have been trained and is thus thoroughly acquainted with the knowledge related to this work.
Qualified service person	<ul style="list-style-type: none"> The qualified service person is a person who installs, repairs, maintains, relocates and removes the air conditioners made by Toshiba Carrier Corporation. He or she has been trained to install, repair, maintain, relocate and remove the air conditioners made by Toshiba Carrier Corporation or, alternatively, he or she has been instructed in such operations by an individual or individuals who have been trained and is thus thoroughly acquainted with the knowledge related to these operations. The qualified service person who is allowed to do the electrical work involved in installation, repair, relocation and removal has the qualifications pertaining to this electrical work as stipulated by the local laws and regulations, and he or she is a person who has been trained in matters relating to electrical work on the air conditioners made by Toshiba Carrier Corporation or, alternatively, he or she has been instructed in such matters by an individual or individuals who have been trained and is thus thoroughly acquainted with the knowledge related to this work. The qualified service person who is allowed to do the refrigerant handling and piping work involved in installation, repair, relocation and removal has the qualifications pertaining to this refrigerant handling and piping work as stipulated by the local laws and regulations, and he or she is a person who has been trained in matters relating to refrigerant handling and piping work on the air conditioners made by Toshiba Carrier Corporation or, alternatively, he or she has been instructed in such matters by an individual or individuals who have been trained and is thus thoroughly acquainted with the knowledge related to this work. The qualified service person who is allowed to work at heights has been trained in matters relating to working at heights with the air conditioners made by Toshiba Carrier Corporation or, alternatively, he or she has been instructed in such matters by an individual or individuals who have been trained and is thus thoroughly acquainted with the knowledge related to this work.

Definition of Protective Gear





When the air conditioner is to be transported, installed, maintained, repaired or removed, wear protective gloves and 'safety' work clothing.

In addition to such normal protective gear, wear the protective gear described below when undertaking the special work detailed in the table below.

Failure to wear the proper protective gear is dangerous because you will be more susceptible to injury, burns, electric shocks and other injuries.

Work undertaken	Protective gear worn
All types of work	Protective gloves 'Safety' working clothing
Electrical-related work	Gloves to provide protection for electricians Insulating shoes Clothing to provide protection from electric shock
Work done at heights (50 cm or more)	Helmets for use in industry
Transportation of heavy objects	Shoes with additional protective toe cap
Repair of outdoor unit	Gloves to provide protection for electricians

■ Warning indications on the air conditioner unit

Warning indication		Description
 <p>WARNING ELECTRICAL SHOCK HAZARD Disconnect all remote electric power supplies before servicing.</p>	<p>WARNING ELECTRICAL SHOCK HAZARD Disconnect all remote electric power supplies before servicing.</p>	
 <p>WARNING Moving parts. Do not operate unit with grille removed. Stop the unit before the servicing.</p>	<p>WARNING Moving parts. Do not operate unit with grille removed. Stop the unit before the servicing.</p>	
 <p>CAUTION High temperature parts. You might get burned when removing this panel.</p>	<p>CAUTION High temperature parts. You might get burned when removing this panel.</p>	
 <p>CAUTION Do not touch the aluminum fins of the unit. Doing so may result in injury.</p>	<p>CAUTION Do not touch the aluminium fins of the unit. Doing so may result in injury.</p>	
 <p>CAUTION BURST HAZARD Open the service valves before the operation, otherwise there might be the burst.</p>	<p>CAUTION BURST HAZARD Open the service valves before the operation, otherwise there might be the burst.</p>	

1 Precautions for safety

The manufacturer shall not assume any liability for the damage caused by not observing the description of this manual.

WARNING

General

- Before starting to install the air conditioner, read through the Installation Manual carefully, and follow its instructions to install the air conditioner.
- Only a qualified installer (*1) or qualified service person (*1) is allowed to do installation work. Inappropriate installation may result in water leakage, electric shock or fire.
- Do not use any refrigerant different from the one specified for complement or replacement. Otherwise, abnormally high pressure may be generated in the refrigeration cycle, which may result in a failure or explosion of the product or an injury to your body.
- Before opening the intake grille of the indoor unit or service panel of the outdoor unit, set the circuit breaker to the OFF position. Failure to set the circuit breaker to the OFF position may result in electric shocks through contact with the interior parts. Only a qualified installer (*1) or qualified service person (*1) is allowed to remove the intake grille of the indoor unit or service panel of the outdoor unit and do the work required.
- Before carrying out the installation, maintenance, repair or removal work, set the circuit breaker to the OFF position. Otherwise, electric shocks may result.
- Place a "Work in progress" sign near the circuit breaker while the installation, maintenance, repair or removal work is being carried out. There is a danger of electric shocks if the circuit breaker is set to ON by mistake.
- Only a qualified installer (*1) or qualified service person (*1) is allowed to undertake work at heights using a stand of 50 cm or more or to remove the intake grille of the indoor unit to undertake work.
- Wear protective gloves and safety work clothing during installation, servicing and removal.
- Do not touch the aluminium fin of the unit. You may injure yourself if you do so. If the fin must be touched for some reason, first put on protective gloves and safety work clothing, and then proceed.
- Before opening the intake grille, set the circuit breaker to the OFF position. Failure to set the circuit breaker to the OFF position may result in injury through contact with the rotation parts. Only a qualified installer (*1) or qualified service person (*1) is allowed to remove the intake grille and do the work required.
- When work is performed at heights, use a ladder which complies with the ISO 14122 standard, and follow the procedure in the ladder's instructions. Also wear a helmet for use in industry as protective gear to undertake the work.
- Before cleaning the filter or other parts of the outdoor unit, set the circuit breaker to OFF without fail, and place a "Work in progress" sign near the circuit breaker before proceeding with the work.
- Before working at heights, put a sign in place so that no-one will approach the work location, before proceeding with the work. Parts and other objects may fall from above, possibly injuring a person below. While carrying out the work, wear a helmet for protection from falling objects.
- The refrigerant used by this air conditioner is the R410A.
- The air conditioner must be transported in stable condition. If any part of the product is broken, contact the dealer.
- When the air conditioner must be transported by hand, carry it by two or more people.
- Do not move or repair any unit by yourself. There is high voltage inside the unit. You may get electric shock when removing the cover and main unit.
- To transport the air conditioner, wear shoes with additional protective toe caps.
- To transport the air conditioner, do not take hold of the bands around the packing carton. You may injure yourself if the bands should break.

Selection of installation location

- When the air conditioner is installed in a small room, provide appropriate measures to ensure that the concentration of refrigerant leakage occur in the room does not exceed the critical level.
- Do not install in a location where flammable gas leaks are possible. If the gas leak and accumulate around the unit, it may ignite and cause a fire.
- Install the indoor unit at least 2.5 m above the floor level since otherwise the users may injure themselves or receive electric shocks if they poke their fingers or other objects into the indoor unit while the air conditioner is running.
- Do not place any combustion appliance in a place where it is directly exposed to the wind of air conditioner, otherwise it may cause imperfect combustion.

Installation

- When the indoor unit is to be suspended, the designated hanging bolts (M10 or W3/8) and nuts (M10 or W3/8) must be used.
- Install the air conditioner securely in a location where the base can sustain the weight adequately. If the strength is not enough, the unit may fall down resulting in injury.
- Follow the instructions in the Installation Manual to install the air conditioner. Failure to follow these instructions may cause the product to fall down or topple over or give rise to noise, vibration, water leakage or other trouble.
- Carry out the specified installation work to guard against the possibility of high winds and earthquake. If the air conditioner is not installed appropriately, a unit may topple over or fall down, causing an accident.
- If refrigerant gas has leaked during the installation work, ventilate the room immediately. If the leaked refrigerant gas comes in contact with fire, noxious gas may generate.
- Use forklift to carry in the air conditioner units and use winch or hoist at installation of them.

Refrigerant piping

- Install the refrigerant pipe securely during the installation work before operating the air conditioner. If the compressor is operated with the valve open and without refrigerant pipe, the compressor sucks air and the refrigeration cycles is over pressurized, which may cause a injury.
- Tighten the flare nut with a torque wrench in the specified manner. Excessive tighten of the flare nut may cause a crack in the flare nut after a long period, which may result in refrigerant leakage.
- After the installation work, confirm that refrigerant gas does not leak. If refrigerant gas leaks into the room and flows near a fire source, such as a cooking range, noxious gas may be generated.
- When the air conditioner has been installed or relocated, follow the instructions in the Installation Manual and purge the air completely so that no gases other than the refrigerant will be mixed in the refrigerating cycle. Failure to purge the air completely may cause the air conditioner to malfunction.
- Nitrogen gas must be used for the airtight test.
- The charge hose must be connected in such a way that it is not slack.

Electrical wiring

- Only a qualified installer (*1) or qualified service person (*1) is allowed to carry out the electrical work of the air conditioner. Under no circumstances must this work be done by an unqualified individual since failure to carry out the work properly may result in electric shocks and/or electrical leaks.
- To connect the electrical wires, repair the electrical parts or undertake other electrical jobs, wear gloves to provide protection for electricians, insulating shoes and clothing to provide protection from electric shocks. Failure to wear this protective gear may result in electric shocks.
- Use wiring that meets the specifications in the Installation Manual and the stipulations in the local regulations and laws. Use of wiring which does not meet the specifications may give rise to electric shocks, electrical leakage, smoking and/or a fire.
- Connect earth wire. (Grounding work)
Incomplete grounding causes an electric shock.
- Do not connect earth wires to gas pipes, water pipes, and lightning conductor or telephone earth wires.
- After completing the repair or relocation work, check that the earth wires are connected properly.
- Install a circuit breaker that meets the specifications in the installation manual and the stipulations in the local regulations and laws.
- Install the circuit breaker where it can be easily accessed by the agent.
- When installing the circuit breaker outdoors, install one which is designed to be used outdoors.
- Under no circumstances the power wire must not be extended. Connection trouble in the places where the wire is extended may give rise to smoking and/or a fire.
- Electrical wiring work shall be conducted according to law and regulation in the community and installation manual. Failure to do so may result in electrocution or short circuit.

Test run

- Before operating the air conditioner after having completed the work, check that the electrical control box cover of the indoor unit and service panel of the outdoor unit are closed, and set the circuit breaker to the ON position. You may receive an electric shock if the power is turned on without first conducting these checks.
- If there is any kind of trouble (such as an error display has appeared, smell of burning, abnormal sounds, the air conditioner fails to cool or heat or water is leaking) has occurred in the air conditioner, do not touch the air conditioner yourself but set the circuit breaker to the OFF position, and contact a qualified service person (*1). Take steps to ensure that the power will not be turned on (by marking "out of service" near the circuit breaker, for instance) until qualified service person (*1) arrives. Continuing to use the air conditioner in the trouble status may cause mechanical problems to escalate or result in electric shocks or other trouble.
- After the work has finished, use an insulation tester set (500 V Megger) to check the resistance is 1 MΩ or more between the charge section and the non-charge metal section (Earth section). If the resistance value is low, a disaster such as a leak or electric shock is caused at user's side.
- Upon completion of the installation work, check for refrigerant leaks and check the insulation resistance and water drainage. Then conduct a test run to check that the air conditioner is operating properly.

Explanations given to user

- Upon completion of the installation work, tell the user where the circuit breaker is located. If the user does not know where the circuit breaker is, he or she will not be able to turn it off in the event that trouble has occurred in the air conditioner.
- If the fan grille is damaged, do not approach the outdoor unit but set the circuit breaker to the OFF position, and contact a qualified service person (*1) to have the repairs done. Do not set the circuit breaker to the ON position until the repairs are completed.
- After the installation work, follow the Owner's Manual to explain to the customer how to use and maintain the unit.

Relocation

- Only a qualified installer (*1) or qualified service person (*1) is allowed to relocate the air conditioner. It is dangerous for the air conditioner to be relocated by an unqualified individual since a fire, electric shocks, injury, water leakage, noise and/or vibration may result.
- When carrying out the pump-down work shut down the compressor before disconnecting the refrigerant pipe. Disconnecting the refrigerant pipe with the service valve left open and the compressor still operating will cause air or other gas to be sucked in, raising the pressure inside the refrigeration cycle to an abnormally high level, and possibly resulting in rupture, injury or other trouble.

CAUTION

New refrigerant air conditioner installation

- **This air conditioner adopts the new HFC refrigerant (R410A) which does not destroy ozone layer.**
- The characteristics of R410A refrigerant are; easy to absorb water, oxidizing membrane or oil, and its pressure is approx. 1.6 times higher than that of refrigerant R22. Accompanied with the new refrigerant, refrigerating oil has also been changed. Therefore, do not let water, dust, former refrigerant, or refrigerating oil enter the refrigerating cycle during installation work.
- To prevent charging an incorrect refrigerant and refrigerating oil, the sizes of connecting sections of charging port of the main unit and installation tools are changed from those for the conventional refrigerant.
- Accordingly the exclusive tools are required for the new refrigerant (R410A).
- For connecting pipes, use new and clean piping designed for R410A, and please care so that water or dust does not enter.









To disconnect the appliance from main power supply.

- This appliance must be connected to the main power supply by means of a switch with a contact separation of at least 3 mm.

The installation fuse (all types can be used) must be used for the power supply line of this conditioner.

(*1) Refer to the "Definition of Qualified Installer or Qualified Service Person."

2 Accessory parts

Part name	Q'ty	Shape	Usage
Installation Manual	1	This manual	(Hand over to customers) (For other languages that do not appear in this Installation Manual, please refer to the enclosed CD-R.)
Owner's Manual	1		(Hand over to customers) (For other languages that do not appear in this Owner's Manual, please refer to the enclosed CD-R.)
CD-ROM	1	—	Owner's Manual and Installation Manual
Heat insulating pipe	2		For heat insulation of pipe connecting section
Installation pattern	1	—	Drawing-out port of hanging bolt pipe
Washer	4	M10 × Ø25	For holding down unit
Hose band	2		For connecting drain pipe
Drain hose	1		For connecting drain pipe
Bushing	1		For protection of edge at power taking-in port
Heat insulator	1		For heat insulation of drain hose (10 t × 190 × 190)
Heat insulator of top plate	1		For upper pipe hole of indoor unit (6 t × 120 × 160)
Banding band	6		For heat insulation of pipe connecting section (n=4) and drain hose heat insulator (n=2).

3 Selection of installation place

Avoid installing in the following places.

Select a location for the indoor unit where the cool or warm air will circulate evenly.

Avoid installation in the following kinds of locations.

- Saline area (coastal area).
- Locations with acidic or alkaline atmospheres (such as areas with hot springs, factories where chemicals or pharmaceuticals are made and places where the exhaust air from combustion appliances will be sucked into the unit).
Doing so may cause the heat exchanger (its aluminum fins and copper pipes) and other parts to become corroded.
- Places where iron or other metal dust is present. If iron or other metal dust adheres to or collects on the interior of the air conditioner, it may spontaneously combust and start a fire.
- Locations with atmospheres with mist of cutting oil or other types of machine oil.
Doing so may cause the heat exchanger to become corroded, mists caused by the blockage of the heat exchanger to be generated, the plastic parts to be damaged, the heat insulators to peel off, and other such problems to result.
- Locations where vapors from food oils are formed (such as kitchens where food oils are used).
Blocked filters may cause the air conditioner's performance to deteriorate, condensation to form, the plastic parts to be damaged, and other such problems to result.
- Locations near obstructions such as ventilation openings or lighting fixtures where the flow of the blown air will be disrupted (a disruption of the air flow may cause the air conditioner's performance to deteriorate or the unit to shut down).
- Locations where an in-house power generator is used for the power supply.
The power line frequency and voltage may fluctuate, and the air conditioner may not work properly as a result.
- On truck cranes, ships or other moving conveyances.
- The air conditioner must not be used for special applications (such as for storing food, plants, precision instruments or art works).
(The quality of the items stored may be degraded.)
- Locations where high frequencies are generated (by inverter equipment, in-house power generators, medical equipment or communication equipment).
(Malfunctioning or control trouble in the air conditioner or noise may adversely affect the equipment's operation.)
- Locations where there is anything under the unit installed that would be compromised by wetness.
(If the drain has become blocked or when the humidity is over 80 %, condensation from the indoor unit will drip, possibly causing damage to anything underneath.)
- In the case of the wireless type of system, rooms with the inverter type of fluorescent lighting or locations exposed to direct sunlight.
(The signals from the wireless remote controller may not be sensed.)
- Locations where organic solvents are being used.
- The air conditioner cannot be used for liquefied carbonic acid cooling or in chemical plants.
- Location near doors or windows where the air conditioner may come into contact with high-temperature, high-humidity outdoor air.
(Condensation may occur as a result.)
- Locations where special sprays are used frequently.

■ Installation space

(Unit: mm)

Reserve sufficient space required for installation or service work.

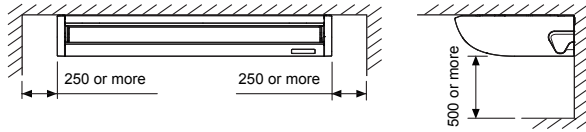

■ Ceiling height

Model RAV-	Possible installed ceiling height
SM56, SM80	Up to 4.0 m
SM110, SM140, SM160	Up to 4.3 m

If height of ceiling exceeds 3.5 m, hot air becomes difficult to reach the floor surface, and then the change of setup of high ceiling is necessary.

For the change method of high ceiling, refer to the application control, "Installing indoor unit on high ceiling" in this Manual.

▼ Height list of ceiling possible to be installed

Model RAV-	SM56, SM80	SM110, SM140, SM160	SET DATA
Standard (Factory default)	Up to 3.5 m	Up to 3.5 m	0000
High ceiling (1)	Up to 4.0 m	Up to 4.3 m	0003

The lighting time of the filter sign (notification of filter cleaning) on the remote controller can be changed according to installation conditions.

When it is difficult to obtain satisfactory heating due to location place of the indoor unit or the structure of the room, the detection temperature of heating can be raised.

For change the setup time, refer to the application control, "Filter sign setting" and "To secure better effect of heating" in this Manual.

■ In case of wireless type

Decide the position which remote controller is operated and the installation place.

And then refer to the Installation Manual of the wireless remote controller kit sold separately.

(The signal of the wireless type remote controller can be received within approx. 8 m. This distance is a criterion and varies a little according to capacity of the battery)

- To prevent malfunction, select a place where is not affected by a fluorescent lamp or direct sunlight.
- Two wireless-type indoor units can be set in a room.

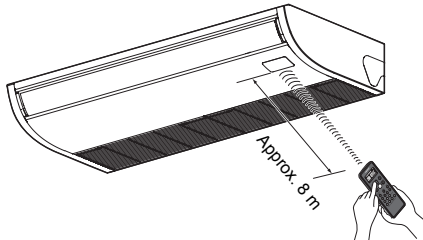

4 Installation

⚠ CAUTION

Strictly comply with the following rules to prevent damage of the indoor units and human injury.

- Do not put a heavy article on the indoor unit or let a person get on it. (Even units are packaged)
- Carry in the indoor unit as it is packaged if possible. If carrying in the indoor unit unpacked by necessity, use buffering cloth or other material to not damage the unit.
- Carry the package by two or more persons, and do not bundle it with plastic band at positions other than specified.
- To install vibration isolation material to hanging bolts, confirm that it does not increase the unit vibration.

■ External dimensions

(Unit: mm)

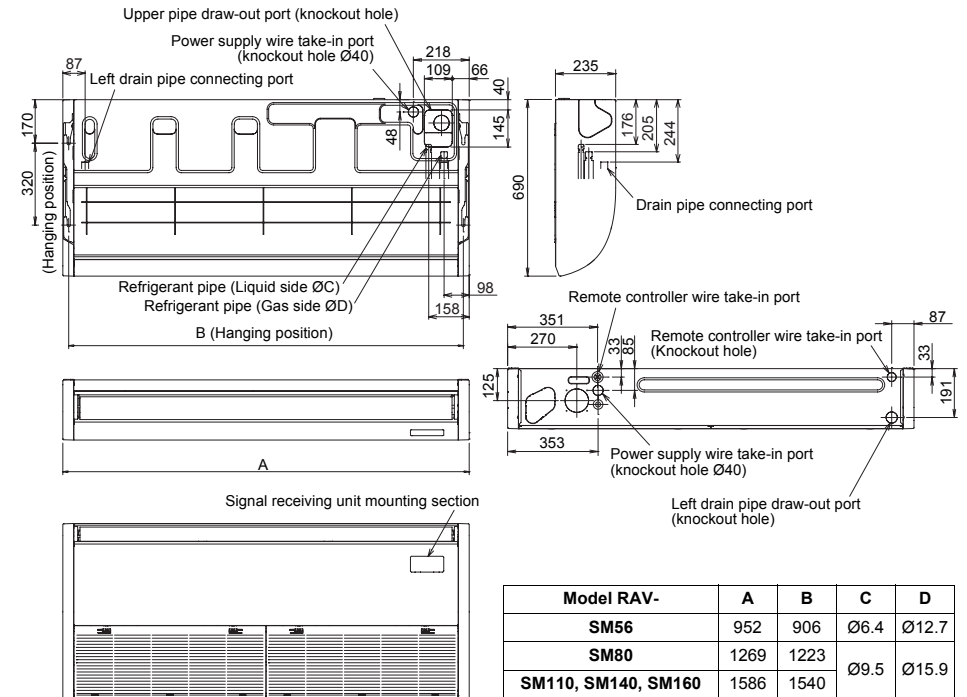

Installation of hanging bolt

- Consider the piping / wiring after the unit is hung to determine the location of the indoor unit installation and orientation.
- After the location of the indoor unit installation has been determined, install hanging bolts.
- For the dimensions of the hanging bolt pitches, refer to the external view and installation pattern.

Procure hanging bolts washer and nuts for installing the indoor unit (these are not supplied).

Hanging bolt	M10 or W3/8	4 pieces
Nut	M10 or W3/8	8 pieces

- To fasten the hanging bracket from above and below, twelve pieces of nuts are required.

How to use attached installation pattern

Using the pattern, positioning of the hanging bolt and pipe hole can be performed.

The installation pattern is printed on the packing carton. Cut it off the carton.

* As an error to some degree may generate on the pattern size due to temperature and humidity, be sure to confirm the size.

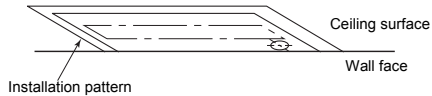

Hole for drawing out pipe from top face (Bottom View)

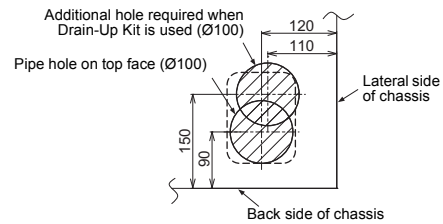

Hole for drawing out pipe from back side (Front View)

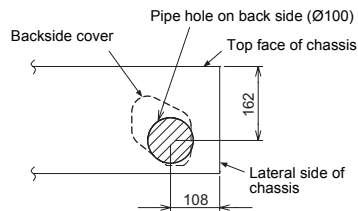

Installation of hanging bolt

Use M10 hanging bolts (4 pcs, locally procured). Matching to the existing structure, set pitch according to size in the "External dimensions".

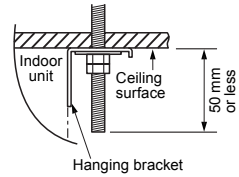

New concrete slab Install the bolts with insert brackets or anchor bolts. (Blade type bracket) (Slide type bracket) (Pipe hanging anchor bolt)	
Steel frame structure Use existing angles or install new support angles. Hanging bolt, Hanging bolt, Support angle	
Existing concrete slab Use a hole-in anchors, hole-in plugs, or a hole-in bolts. 	

Installation of remote controller (Sold separately)

For installation of the remote controller, follow the Installation Manual attached with the remote controller.

- Pull out the remote controller cord together with the refrigerant pipe or drain pipe. Pass the remote controller cord through upper side of the refrigerant pipe and drain pipe.
- Do not leave the remote controller at a place exposed to the direct sunlight and near a stove.
- Operate the remote controller, confirm that the indoor unit receives a signal surely, and then install it. (Wireless type)
- Keep 1 m or more from the devices such as television, stereo. (Disturbance of image or noise may generate.) (Wireless type)

Before installation

1 Removal of air intake grille

- Remove the screws of air intake grille fixing knob on a side of each filter.
- Slide the air intake grille fixing knobs (two positions) toward the arrow direction (OPEN), and then open the air intake grille.
- With the air intake grille open, hold the hinge from above and below with one hand and take out the air intake grille with the other hand while gently pushing it. (There are two air intake grilles.)

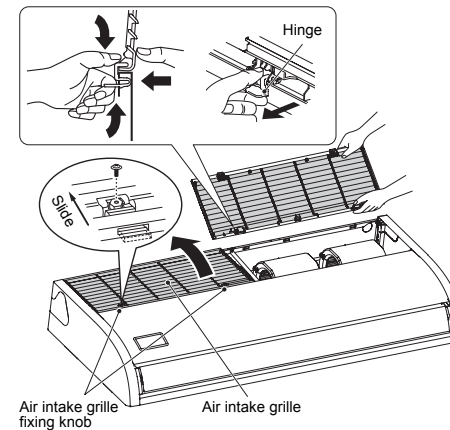

2 Removal of side panel

- After removing the side panel fixing screws (1 each at right and left), slide the side panel forward and then remove it.

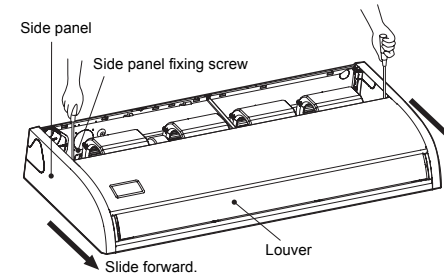

CAUTION

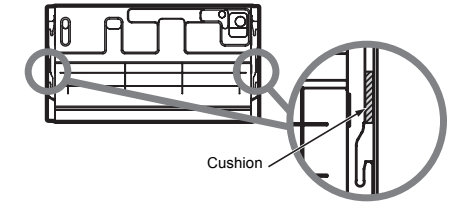

Cushions are inserted between the side panel and hanging hook for transportation. (In the two places shown above) Remove them before installation.

■ Draw-out direction of pipe / wire

Decide installation place of the unit and draw-out direction of pipe and wire.

■ Pipe knockout hole

In case of taking pipe from the rear side

* Cut off the groove section with a plastic cutter.

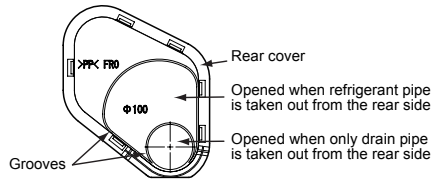

<In case of taking pipe from right side>

* Cut off the groove section with a metal saw or plastic cutter.

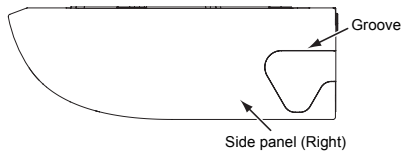

<In case of taking pipe from left side>

Taking pipe from left side is applied only to the drain pipe.

The refrigerant pipe cannot be taken out from the left side.

* Cut off the groove section with a metal saw or plastic cutter.

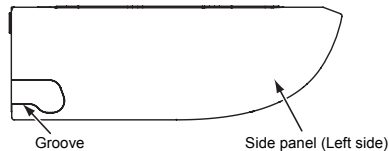

<In case of taking pipe from upper side>

Taking pipe from upper side is applied only to the refrigerant pipe.

When taking out the drain pipe from the upper side, use a drain up kit sold separately.

Open the upper pipe draw-out port (Knockout hole) shown in the external dimensions.

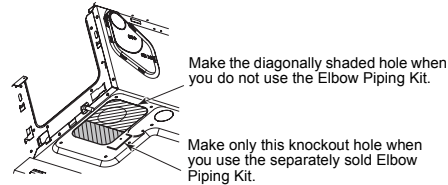

After piping, cut off the attached heat insulator of the top plate to pipe shape, and then seal the knockout hole.

■ Knockout hole of power wire take-in port

Open the power wire take-in port (Knockout hole) shown in the "External dimensions" and then mount the attached bushing.

■ Installation of indoor unit

◆ Preparation before holding down main unit

* Confirm the presence of the ceiling material beforehand because the fixing method of hanging metal when the ceiling material is set differs from that when the ceiling material is not set.

<There is ceiling material>

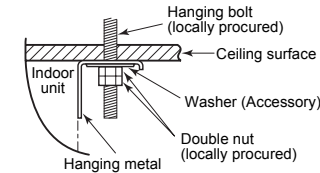

* Fix the hanging bracket as shown below if the ceiling is bent upwards when you fasten lower nuts to the hanging bracket.

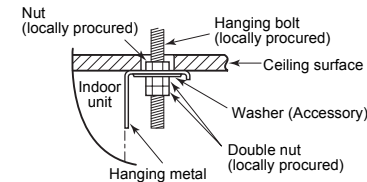

<There is no ceiling material>

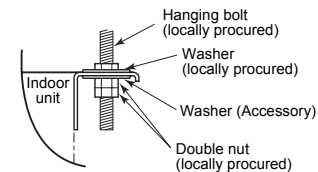

◆ Holding down of main unit

<Hanging the indoor unit directly from the ceiling>

1 Attach washer and nuts to the hanging bolt.

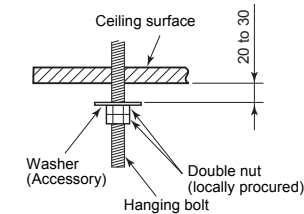

2 Hang the unit to the hanging bolt as shown the figure below.

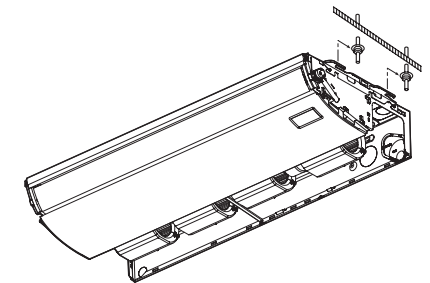

3 As shown in the figure below, fix the ceiling material securely with the double nuts.

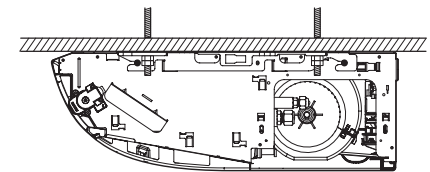

◆ Attaching the hanging bracket first

1 Remove the screws fastening hanging bracket onto the indoor unit.

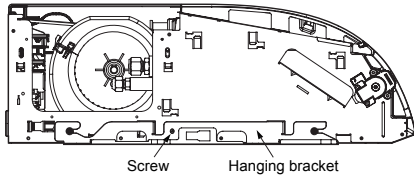

2 Loosen the bolts fastening hanging bracket onto the indoor unit and remove the hanging bracket.

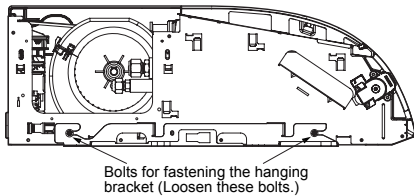

3 Adjust the length of the two bolts for fastening the hanging bracket, as shown below.

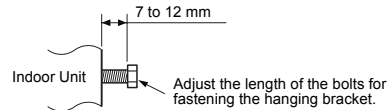

4 Fasten the hanging bracket with the hanging bolts and ensure that the bracket is level from front to back and from side to side.

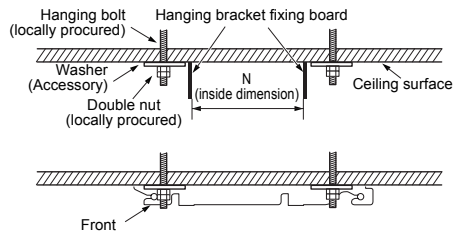

(Unit : mm)

Model RAV-	N
SM56	867 to 874
SM80	1184 to 1191
SM110 ~ SM160	1501 to 1508

5 Attach the indoor unit onto the hanging bracket and fasten it tight with the bolts and screws.

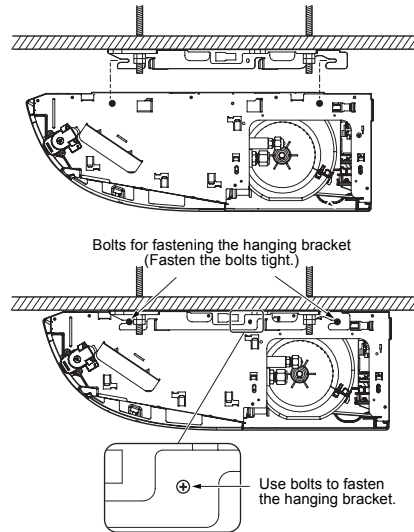

⚠ CAUTION

- The ceiling is not always level. Use the level gauge to measure the level of the ceiling in the width and depth directions. Adjust the bolts for the hanging brackets so that the level error will be within 5 mm.
- Do not lower the air discharge side and the side opposite to the selected drain pipe withdraw.

5 Drain piping

⚠ CAUTION

Following the Installation Manual, perform the drain piping work so that water is properly drained. Apply a heat insulation so as not to cause a dew condensation. Inappropriate piping work may result in water leakage in the room and wet furniture.

- Provide the indoor drain piping with proper heat insulation.
- Provide the area where the pipe connects to the indoor unit with proper heat insulation. Improper heat insulation will cause condensation to form.
- The drain pipe must be sloping downward (at an angle of 1/100 or more), and do not run the pipe up and down (arched shape) or allow it to form traps. Doing so may cause abnormal sounds.
- Restrict the length of the traversing drain pipe to 20 meters or less. For a long pipe, provide support brackets at intervals of 1.5 to 2 meters to prevent flapping.
- Install the collective piping as shown in the following figure.
- Do not provide any air vents. Otherwise, the drain water will spout, causing water to leak.
- Do not allow any force to be applied to the connection area with the drain pipe.
- A hard PVC pipe cannot be connected to the drain pipe connecting port of the indoor unit. Be absolutely sure to use the flexible hose provided for the connections with the drain pipe connecting port.
- Adhesive agents cannot be used for the drain pipe connecting port (hard socket) of the indoor unit. Be absolutely sure to secure the pipe using the hose bands provided. Use of an adhesive agent may damage the drain pipe connecting port or cause water to leak.

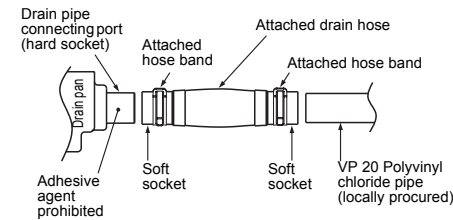
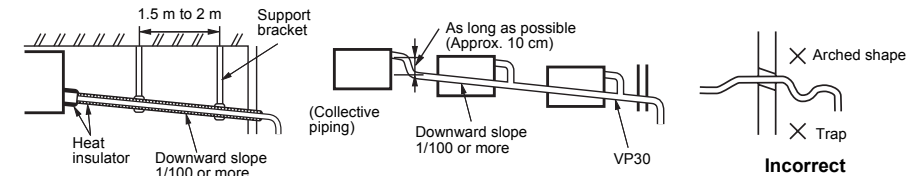

■ Pipe material, size and insulator

The following materials for piping work and insulating process are procured locally.

Pipe material	Hard vinyl chloride pipe VP20 (Nominal outer diameter Ø26 mm)
Insulator	Foamed polyethylene foam, thickness: 10 mm or more

■ Connection of drain hose

- Insert the attached drain hose into the drain pipe connecting port on the drain pan up to the end.
- Fit the attached hose band to the end of the pipe connecting port, and then tighten it securely.

REQUIREMENT

- Fix the drain hose with the attached hose band, and set the tightening position upward.
- As the draining is the natural water draining, arrange the pipe outside of the unit on the down slope.
- If piping is performed as shown in the figure, drain cannot be discharged.

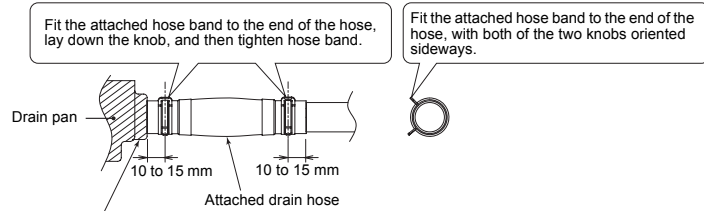
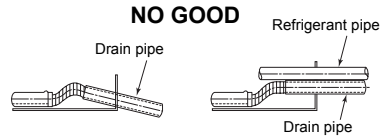

Confirm that soft hose is pushed in up to the end of the drain pan.

■ Connecting drain pipe

Connect the hard vinyl chloride pipe (locally procured) to the mounted drain hose which was attached.

In case of taking pipe from the left side

In case of taking pipe from the left side, exchange the plug from left to right. Push in the plug of which end is not sharp up to the end.

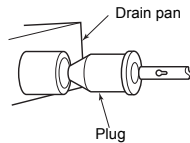

■ Drain up

When a down-gradient cannot be secured for the drain pipe, drain-up piping is possible.

- The height of the drain pipe must be 600 mm or less from the underside of the indoor unit.
- * When Drain Pump Kit (sold separately) is installed, drain pipe and refrigerant pipe can only be connected from upper direction.

■ Heat insulating process

- Using the attached drain hose heat insulator, lap the connecting section and the drain hose without clearance, and then tighten with two handing band so that heat insulator does not open.
- Covering the attached drain hose heat insulator, lap the heat insulator (locally procured) to the drain pipe without clearance.

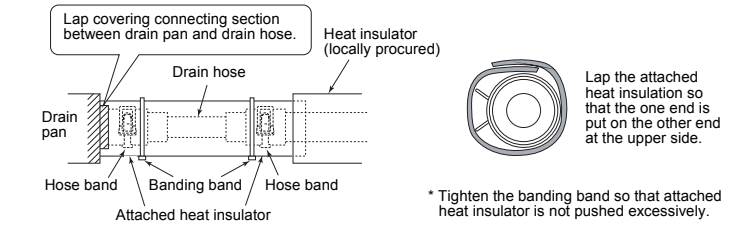

* Fasten the binding bands in such a manner as to not squeeze the attached insulating material excessively.

* Tighten the banding band so that attached heat insulator is not pushed excessively.

6 Refrigerant piping

CAUTION

When the refrigerant pipe is long, provide support brackets at intervals of 2.5 m to 3 m to clamp the refrigerant pipe. Otherwise, abnormal sound may be generated.
Use the flare nut attached with the indoor unit or R410A flare nut.

Take out direction of refrigerant pipe

- The refrigerant pipe connecting sections are located as shown below. (Pipes can be taken out from one of the three directions.)
- Make a pipe knockout hole, referring to the section "Pipe knockout hole".

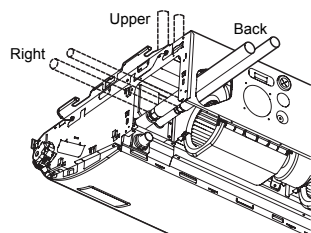

* When Drain Pump Kit (sold separately) is installed, a refrigerant pipe can only be taken out from upper direction.

Permissible piping length and height difference

They vary depending on the outdoor unit. For details, refer to the Installation Manual attached to the outdoor unit.

Pipe size

Model RAV-	Pipe size (mm)	
	Gas side	Liquid side
SM56	Ø12.7	Ø6.4
SM80 ~ SM160	Ø15.9	Ø9.5

Connecting refrigerant piping

Flaring

1 Cut the pipe with a pipe cutter.

Remove burrs completely. (Remaining burrs may cause gas leakage.)

2 Insert a flare nut into the pipe, and flare the pipe.

Use the flare nut provided with the unit or the one used for the R410A refrigerant. The flaring dimensions for R410A are different from the ones used for the conventional R22 refrigerant. A new flare tool manufactured for use with the R410A refrigerant is recommended, but the conventional tool can still be used if the projection margin of the copper pipe is adjusted to be as shown in the following table.

Projection margin in flaring: B (Unit: mm)

Outer dia. of copper pipe	R410A tool used	Conventional tool used
6.4, 9.5	0 to 0.5	1.0 to 1.5
12.7, 15.9		

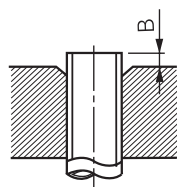

Flaring diameter size: A (Unit: mm)

Outer dia. of copper pipe	A $\begin{matrix} +0 \\ -0.4 \end{matrix}$
6.4	9.1
9.5	13.2
12.7	16.6
15.9	19.7

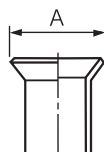

- * In case of flaring for R410A with the conventional flare tool, pull it out approx. 0.5 mm more than that for R22 to adjust to the specified flare size. The copper pipe gauge is useful for adjusting projection margin size.
- The sealed gas was sealed at the atmospheric pressure so when the flare nut is removed, there will no "whooshing" sound: This is normal and is not indicative of trouble.
- Use two wrenches to connect the indoor unit pipe.

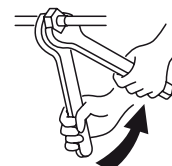

Work using double spanner

- Use the tightening torque levels as listed in the table below.

Outer dia. of connecting pipe (mm)	Tightening torque (N·m)
6.4	14 to 18 (1.4 to 1.8 kgf·m)
9.5	34 to 42 (3.4 to 4.2 kgf·m)
12.7	49 to 61 (4.9 to 6.1 kgf·m)
15.9	63 to 77 (6.3 to 7.7 kgf·m)

- Tightening torque of flare pipe connections. Pressure of R410A is higher than that of R22. (Approx. 1.6 times) Therefore, using a torque wrench, tighten the flare pipe connecting sections which connect the indoor and outdoor units of the specified tightening torque. Incorrect connections may cause not only a gas leak, but also a trouble of the refrigeration cycle.

CAUTION

Tightening with an excessive torque may crack the nut depending on installation conditions.

Evacuation

Perform vacuuming from the charge port of valve of the outdoor unit by using a vacuum pump.

For details, follow to the Installation Manual attached to the outdoor unit.

- Do not use the refrigerant sealed in the outdoor unit for evacuation.

REQUIREMENT

For the tools such as charge hose, use those manufactured exclusively for R410A.

Refrigerant amount to be added

For addition of the refrigerant, add refrigerant "R410A" referring to the attached Installation Manual of outdoor unit.

Use a scale to charge the refrigerant of specified amount.

REQUIREMENT

- Charging an excessive or too little amount of refrigerant causes a trouble of the compressor. Charge the refrigerant of specified amount.
- A personnel who charged the refrigerant should write down the pipe length and the added refrigerant amount in the F-GAS label of the outdoor unit. It is necessary to fix the compressor and refrigeration cycle malfunction.

Open the valve fully

Open the valve of the outdoor unit fully. A 4 mm-hexagonal wrench is required for opening the valve.

For details, refer to the Installation Manual attached to the outdoor unit.

Gas leak check

Check with a leak detector or soap water whether gas leaks or not, from the pipe connecting section or cap of the valve.

REQUIREMENT

Use a leak detector manufactured exclusively for HFC refrigerant (R410A, R134a).

Heat insulation process

Apply heat insulation for the pipes separately at liquid side and gas side.

- For the heat insulation to the pipes at gas side, use the material with heat-resisting temperature 120 °C or higher.
- To use the attached heat insulation pipe, apply the heat insulation to the pipe connecting section of the indoor unit securely without gap.

REQUIREMENT

- Apply the heat insulation to the pipe connecting section of the indoor unit securely up to the root without exposure of the pipe. (The pipe exposed to the outside causes water leak.)
- Wrap heat insulator with its slits facing up (ceiling side).

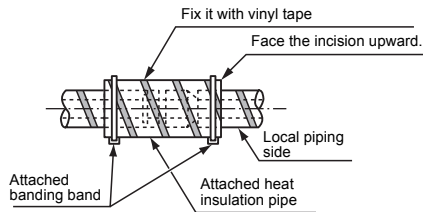

7 Electrical connection

⚠ WARNING

- **Use the specified wires for wiring connect the terminals. Securely fix them to prevent external forces applied to the terminals from affecting the terminals.**
Incomplete connection or fixation may cause a fire or other trouble.
- **Connect earth wire. (grounding work)**
Incomplete grounding cause an electric shock.
Do not connect earth wires to gas pipes, water pipes, lightning conductor or telephone earth wires.
- Appliance shall be installed in accordance with national wiring regulations.
Capacity shortage of power circuit or incomplete installation may cause an electric shock or a fire.

⚠ CAUTION

- Do not connect 220 – 240 V power to the terminal blocks (Ⓐ, Ⓑ) for control wiring.
Otherwise, the system will fail.
- Do not damage or scratch the conductive core and inner insulator of power and system interconnection wires when peeling them.
- Perform the electric wiring so that it does not come to contact with the high-temperature part of the pipe.
The coating may melt resulting in an accident.
- Do not turn on the power of the indoor unit until vacuuming of the refrigerant pipes completes.

■ System interconnection wires specifications

- **For power supply specifications, follow the Installation Manual of outdoor unit. The power of the indoor unit is supplied from the outdoor unit.**

System interconnection wires*	4 x 1.5 mm ² or more (H07 RN-F or 60245 IEC 66)	Up to 70 m
-------------------------------	---	------------

*Number of wire x wire size

Remote controller wiring

Remote controller wiring, remote controller inter-unit wiring	Wire size: 2 × 0.5 to 2.0 mm ²	
Total wire length of remote controller wiring and remote controller inter-unit wiring = L + L1 + L2 + ... Ln	In case of wired type only	Up to 500 m
	In case of wireless type included	Up to 400 m
Total wire length of remote controller inter-unit wiring = L1 + L2 + ... Ln	Up to 200 m	

⚠ CAUTION

The remote controller wire and system interconnection wires cannot be parallel to contact each other and cannot be stored in the same conduits. If doing so, a trouble may be caused on the control system due to noise or other factor.

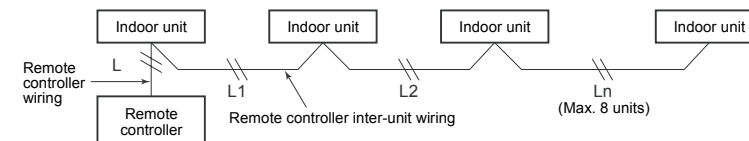

■ Wiring between indoor unit and outdoor unit

- Figure below shows the wiring connections between the indoor and outdoor units and between the indoor units and remote controller. The wires indicated by the broken lines or dot-and-dash lines are provided at the locally.
- Refer to the both indoor and outdoor unit wiring diagrams.

Wiring diagram

Single system

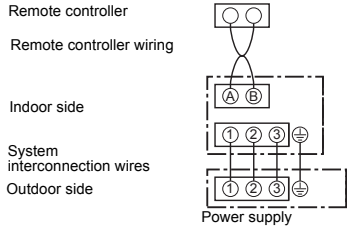

Simultaneous twin system

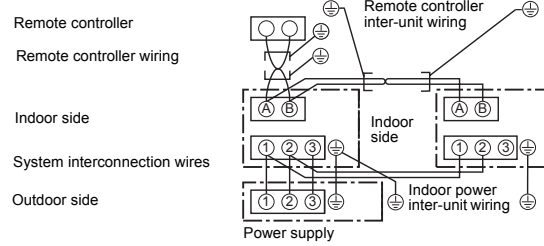

Simultaneous triple and double twin system

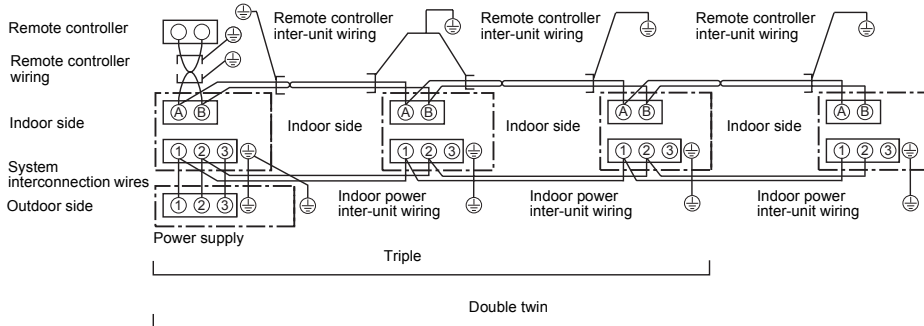

* Use 2-core shield wire (MVVS 0.5 to 2.0 mm² or more) for the remote controller wiring in the simultaneous twin, simultaneous triple and simultaneous double twin systems to prevent noise problems. Connect both ends of the shield wire to earth leads.

* Connect earth wires for each indoor unit in the simultaneous twin, simultaneous triple and simultaneous double twin systems.

◆ Wire connection

REQUIREMENT

- Connect the wires matching the terminal numbers. Incorrect connection causes a trouble.
- Pass the wires through the bushing of wire connection holes of the indoor unit.
- Keep a margin (Approx. 100 mm) on a wire to hang down the electrical control box at servicing.
- The low-voltage circuit is provided for the remote controller. (Do not connect the high-voltage circuit)

- 1 Loosen the cover mounting screws (2 positions) of the electrical control box, and then remove the cover.
- 2 Connect the system interconnection wires and the remote controller wire to the terminal block of the electrical control box.
- 3 Tighten screws of the terminal block securely, and fix the wires with code clamp attached to the electrical control box. (Do not apply tension to the connecting section of the terminal block.)
- 4 Mount the cover of the electrical control box so that it does not pinch the wires.

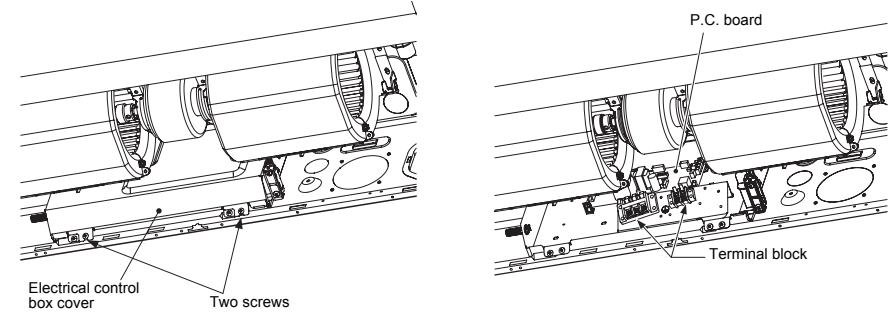

▼ Connecting the system interconnection wire <Single connection>

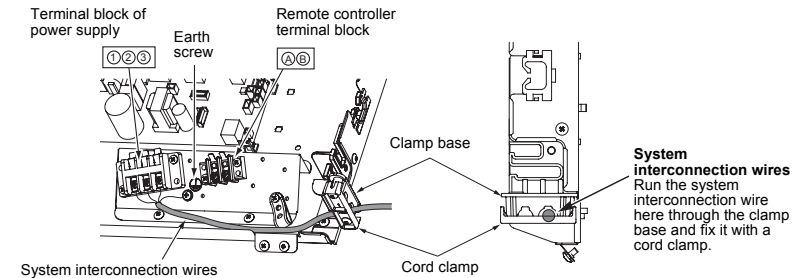

<Multi-indoor-unit connection>

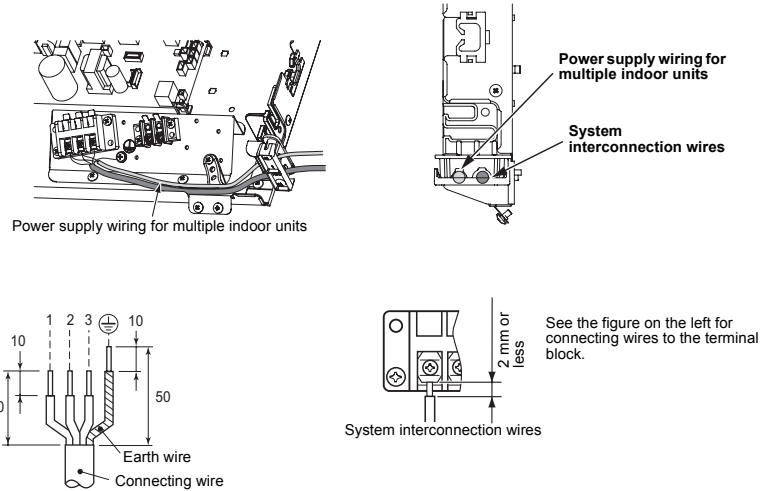

■ Remote controller wiring

Strip off approx. 9 mm the wire to be connected.

Wiring diagram

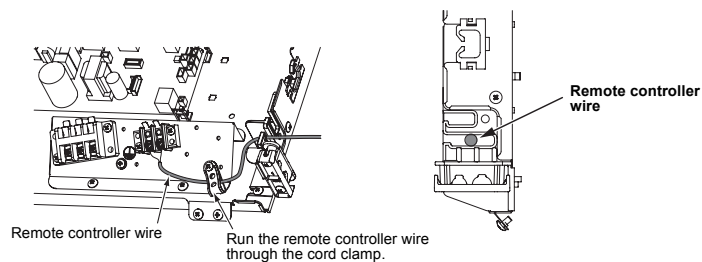
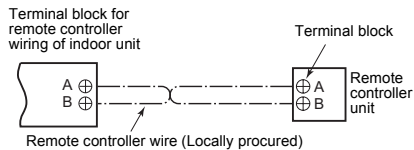

8 Applicable controls

REQUIREMENT

- When you use this air conditioner for the first time, it takes approx. 5 minutes until the remote controller becomes available after power-on. This is normal. **<When power is turned on for the first time after installation>** It takes **approx. 5 minutes** until the remote controller becomes available.

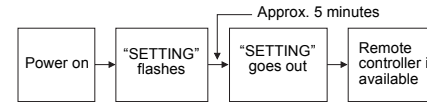

- <When power is turned on for the second (or later) time>** It takes **approx. 1 minute** until the remote controller becomes available.

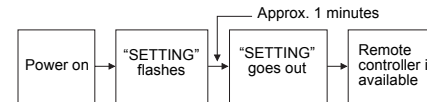

- Normal settings were made when the indoor unit was shipped from factory. Change the indoor unit settings as required.
- Use the wired remote controller to change the settings.
 - The settings cannot be changed using the wireless remote controller, sub remote controller, or remote-controller-less system (for central remote controller only). Therefore, install the wired remote controller to change the settings.

■ Basic procedure for changing settings

Change the settings while the air conditioner is not working. **(Stop the air conditioner before making settings.)**

⚠ CAUTION

Set only the CODE No. shown in the following table: Do NOT set any other CODE No. If a CODE No. not listed is set, it may not be possible to operate the air conditioner or other trouble with the product may result.
 * The displays appearing during the setting process differ from the ones for previous remote controllers (AMT31E). (There are more CODE No.)

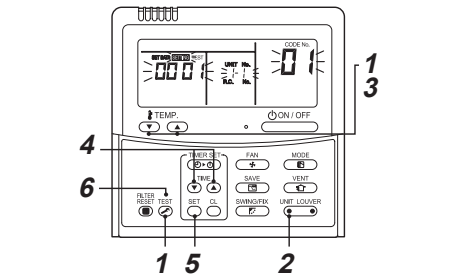

- Push and hold **TEST** button and **"TEMP."** button simultaneously for at least 4 seconds. After a while, the display flashes as shown in the figure. Confirm that the CODE No. is [01].
 - If the CODE No. is not [01], push **TEST** button to clear the display content, and repeat the procedure from the beginning. (No operation of the remote controller is accepted for a while after **TEST** button is pushed.) (While air conditioners are operated under the group control, "ALL" is displayed first. When **UNIT LOUVER** is pushed, the indoor unit number displayed following "ALL" is the header unit.)

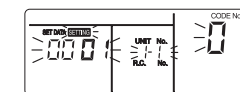

(* Display content varies with the indoor unit model.)

2 Each time **UNIT LOUVER** button is pushed, indoor unit numbers in the control group change cyclically. Select the indoor unit to change settings for.

The fan of the selected unit runs and the louvers start swinging. The indoor unit for change settings can be confirmed.

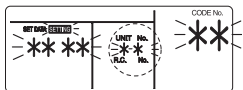

3 Specify CODE No. [**] with "TEMP." \downarrow / \uparrow buttons.

4 Select SET DATA [****] with "TIME" \downarrow / \uparrow buttons.

5 Push **SET** button. When the display changes from flashing to lit, the setup is completed.

- To change settings of another indoor unit, repeat from Procedure 2.
- To change other settings of the selected indoor unit, repeat from Procedure 3.

Use **SET** button to clear the settings. To make settings after **SET** button was pushed, repeat from Procedure 2.

6 When settings have been completed, push **TEST** button to determine the settings.

When **TEST** button is pushed, **SETTING** flashes and then the display content disappears and the air conditioner enters the normal stop mode.

(While **SETTING** is flashing, no operation of the remote controller is accepted.)

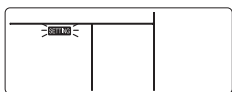

■ Installing indoor unit on high ceiling

When the height of the ceiling to be installed exceeds 3.5 m, adjustment of air volume is necessary.

Set up the high ceiling.

- Set according to the basic operation procedure (1 → 2 → 3 → 4 → 5 → 6).
- CODE No. in Procedure specifies [5d].
- Select [SET DATA] in Procedure from "List of installable ceiling height" in this Manual.
- For the CODE No. in Procedure 3, specify [5d].
- For the CODE No. in Procedure 4, select the SET DATA of ceiling height to be set up from the table on the below.

Model RAV-	SM56, SM80	SM110, SM140, SM160	SET DATA
Standard (Factory default)	Up to 3.5 m	Up to 3.5 m	0000
High ceiling (1)	Up to 4.0 m	Up to 4.3 m	0003

◆ Remote controller-less setting

Change the high-ceiling setting with the DIP switch on the indoor unit P.C. board.

- Once the setting is changed, setting to 0001 is possible, however setting to 0000 requires a setting data change to 0000 using the wired remote controller (separately sold) with the normal switch setting (factory default).

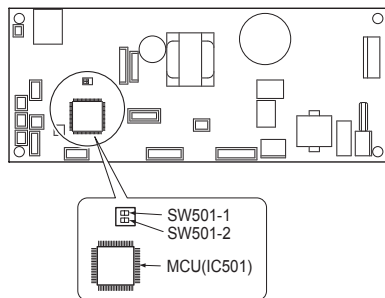

SET DATA	SW501-1	SW501-2
0000 (Factory default)	OFF	OFF
0003	OFF	ON

To restore the factory defaults

To return the DIP switch settings to the factory defaults, set SW501-1 and SW501-2 to OFF, connect a separately sold wired remote controller, and then set the data of CODE No. [5d] to "0000".

■ Filter sign setting

According to the installation condition, the filter sign term (Notification of filter cleaning) can be changed.

Follow to the basic operation procedure

- (1 → 2 → 3 → 4 → 5 → 6).
- For the CODE No. in Procedure 3, specify [01].
- For the [SET DATA] in Procedure 4, select the SET DATA of filter sign term from the following table.

SET DATA	Filter sign term
0000	None
0001	150H
0002	2500H (Factory default)
0003	5000H
0004	10000H

■ To secure better effect of heating

When it is difficult to obtain satisfactory heating due to installation place of the indoor unit or structure of the room, the detection temperature of heating can be raised. Also use a circulator or other device to circulate heat air near the ceiling.

Follow to the basic operation procedure

- (1 → 2 → 3 → 4 → 5 → 6).
- For the CODE No. in Procedure 3, specify [06].
- For the set data in Procedure 4, select the SET DATA of shift value of detection temperature to be set up from the following table.

SET DATA	Detection temperature shift value
0000	No shift
0001	+1 °C
0002	+2 °C (Factory default)
0003	+3 °C
0004	+4 °C
0005	+5 °C
0006	+6 °C

■ Power saving mode

Performing settings of the power saving mode

- When a multiple-unit system is configured for group control, each outdoor unit must be set up.
- When an outdoor unit RAV-SP***2AT / SM***3AT type or earlier is used, the power level is fixed to 75 % regardless of the value on the display.

1 Push **SAVE** button for 4 seconds or more when the air conditioner is not working.

SETTING flashes.

Indicates CODE No. "C2."

2 Select an indoor unit to be set by pushing **UNIT LOUVER** (left side of the button).

Each time the button is pushed, unit numbers change as follows:

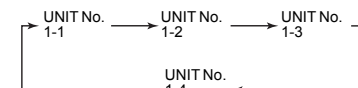

The fan of the selected unit runs.

3 Adjust the power save setting by pushing **TIME** \downarrow / \uparrow buttons.

Each push of the button changes the power level by 1 % within the range from 100 % to 50 %.

*The factory default is 75 %.

*The power level might not drop to the setpoint, depending on the operating conditions.

*All indoor units with the same group address must be set with the same power level.

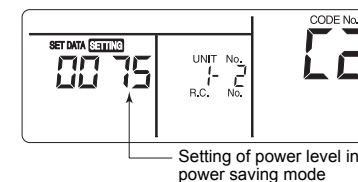

4 Determine the setting by pushing **SET** button.

5 Push **TEST** button to complete the setting.

Remote controller switch monitoring function

This function is available to call the service monitor mode from the remote controller during a test run to acquire temperatures of sensors of the remote controller, indoor unit, and outdoor unit.

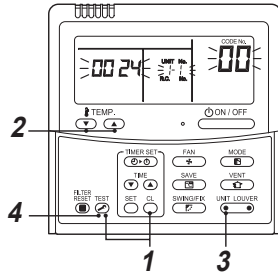

1 Push **UNIT LOUVER** and **TEST** buttons simultaneously for at least 4 seconds to call the service monitor mode.

The service monitor indicator lights up and the header indoor unit number is displayed first. CODE No. **00** is also displayed.

2 Pushing **TEMP.** buttons, select the number of sensor (CODE No.) to be monitored.

(See the following table.)

3 Pushing **UNIT LOUVER** (left side of the button), select an indoor unit to be monitored. The sensor temperatures of indoor units and their outdoor unit in the control group are displayed.

4 Push **TEST** button to return to the normal display.

Indoor unit data	
CODE No.	Data name
01	Room temperature (remote controller)
02	Indoor unit intake air temperature (TA)
03	Indoor unit heat exchanger (coil) temperature (TCJ)
04	Indoor unit heat exchanger (coil) temperature (TC)
F3	Indoor unit fan cumulative operating hours (x1 h)

Outdoor unit data	
CODE No.	Data name
60	Outdoor unit heat exchanger (coil) temperature (TE)
61	Outside air temperature (TO)
62	Compressor discharge temperature (TD)
63	Compressor suction temperature (TS)
64	—
65	Heatsink temperature (THS)
6A	Operating current (x1/10)
F1	Compressor cumulative operating hours (x100 h)

Group control

Simultaneous twin, triple or double twin system

A combination with an outdoor unit allows simultaneous ON / OFF operation of the indoor units. The following system patterns are available.

- Two indoor units for the twin system
- Three indoor units for the triple system
- Four indoor units for the double-twin system

▼ Twin system

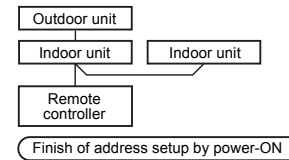

▼ Triple system

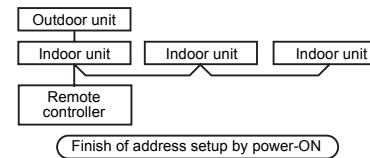

▼ Double twin

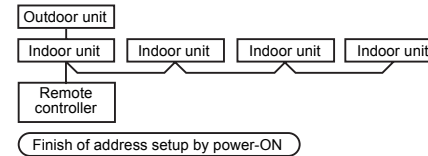

- For wiring procedure and wiring method, follow to the "Electrical connection" in this manual.
- When the power supply has been turned on, the automatic address setup starts and which indicates that address is being set up flashes on the display part.

During setup of automatic address, the remote controller operation is not accepted.

Required time up to the finish of automatic addressing is approx. 5 minutes.

Group control for system of multiple units

One remote controller can control maximum 8 indoor units as a group.

▼ Group control in single system

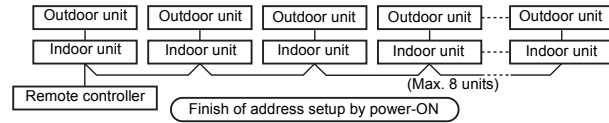

- For wiring procedure and wiring method of the individual line (Identical refrigerant line) system, follow to "Electrical connection".
- Wiring between lines is performed in the following procedure.
Connect the terminal block (A/B) of the indoor unit connected with a remote controller to the terminal blocks (A/B) of the indoor units of other indoor units by wiring the inter-unit wire of the remote controller.
- When the power supply has been turned on, the automatic address setup starts and which indicates that address is being set up flashes on the display part in about 3 minutes. During setup of automatic address, the remote controller operation is not accepted.

Required time up to the finish of automatic addressing is approx. 5 minutes.

NOTE

- In some cases, it is necessary to change the address manually after setup of the automatic address according to the system configuration of the group control.
- The follow mentioned system configuration is a case when complex systems in which systems of the simultaneous twin and simultaneous triple unit is controlled as a group by a remote controller.

(Example) Group control for complex system

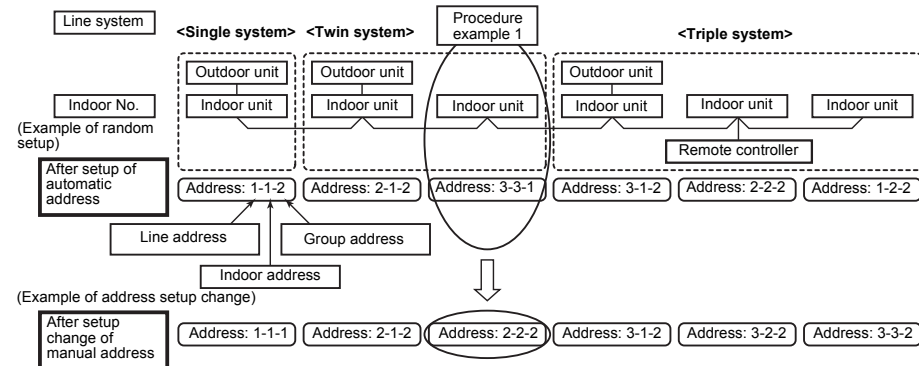

The above address is set by the automatic addressing when the power is turned on. However, line addresses and indoor addresses are set randomly. For this reason, change the setting to match line addresses with indoor addresses.

[Procedure example]

Manual address setup procedure

While the operation stops, change the setup.
(Stop the operation of the unit.)

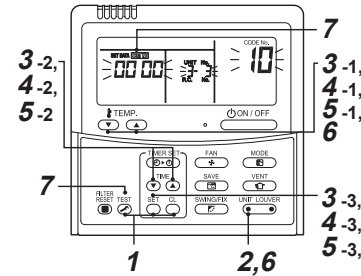

- 1 Push **SET** + **CL** + **TEST** buttons simultaneously for 4 seconds or more. After a while, the display part flashes as shown below. Check the displayed CODE No. is [10].

- When the CODE No. is other than [10], push **TEST** button to erase the display and repeat procedure from the first step.
(After pushing **TEST** button, operation of the remote controller is not accepted for approx. 1 minute.)
(For a group control, No. of the firstly displayed indoor unit becomes the header unit.)

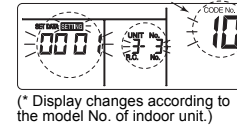

(* Display changes according to the model No. of indoor unit.)

- 2 Every time **UNIT LOWER** button is pushed, the indoor UNIT No. in the group control is displayed in order. Select the indoor unit of which setup is changed.

In this time, the position of the indoor unit of which setup is changed can be confirmed because fan of the selected indoor unit operate.

3

- 1) Specify CODE No. [12] with **TEMP.** **▼** / **▲** buttons.
(CODE No. [12]: Line address)
- 2) Change the line address from [3] to [2] with **TIME** **▼** / **▲** buttons.
- 3) Push **SET** button.
In this time, the setup finishes when the display changes from flashing to lighting.

Indoor unit No. before setup change is displayed.

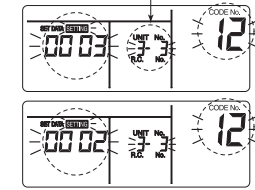

4

- 1) Specify CODE No. [13] with **TEMP.** **▼** / **▲** buttons.
(CODE No. [13]: Indoor address)
- 2) Change the indoor address from [3] to [2] **TIME** **▼** / **▲** buttons.
- 3) Push **SET** button.
In this time, the setup finishes when the display changes from flashing to lighting.

Indoor unit No. before setup change is displayed.

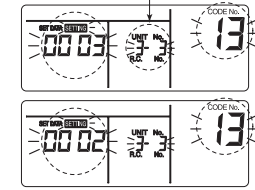

5

- Specify CODE No. [14] TEMP. / buttons.
(CODE No. [14]: Group address)
- Change the SET DATA from [0001] to [0002]
TIME / buttons.
(SET DATA [Header unit: 0001] [Follower unit: 0002])
- Push button.
In this time, the setup finishes when the display changes from flashing to lighting.

Indoor UNIT No. before setup change is displayed.

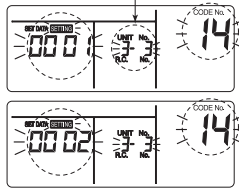

6 If there is other indoor unit to be changed, repeat procedure 2 to 5 to change the setup.

When the above setup has finished, push to select the indoor UNIT No. before change of setup, specify CODE No. [12], [13], [14] in order with TEMP. / buttons, and then check the changed contents.

Address change check

Before change: [3-3-1] → After change: [2-2-2]

Pushing button clears the contents of which setup was changed.

(In this case, procedure from 2 is repeated.)

Indoor UNIT No. before setup change is displayed.

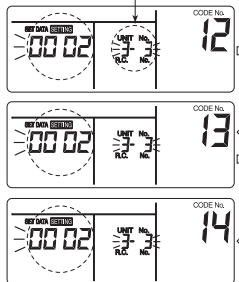

7 After check of the changed contents, push button.

(Setup is determined.)

When button is pushed, the display disappears and the status becomes the usual stop status.

(When button is pushed the operation from the remote controller is not accepted for approx. 1 minute.)

*If the operation from the remote controller is not accepted even 1 minute or more passed after pushing button, it is considered that the address setup is incorrect.

In this case, the automatic address must be again set up.

Therefore repeat procedure of the setup change from the Procedure 1.

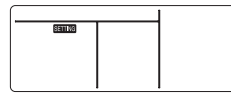

To recognize the position of the corresponding indoor unit though the indoor UNIT No. is known

Check the position during operation stop.

(Stop operation of the set.)

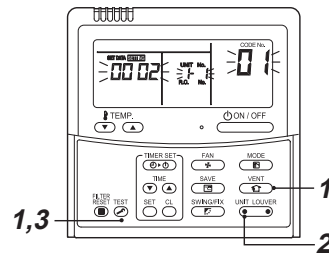

1 Push + buttons simultaneously for 4 seconds or more.

After a while, the display part flashes and the display appears as shown below.

In this time, the position can be checked because fan of the indoor unit operate.

- For the group control, the indoor UNIT No. is displayed as [ALL] and fans of all the indoor units in the group control operate. Check the displayed CODE No. is [01].
- When the CODE No. is other than [01], push button to erase the display and repeat procedure from the first step. (After pushing button, operation of the remote controller is not accepted for approx. 1 minute.)

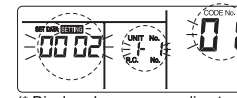

(* Display changes according to the model No. of indoor unit.)

2 In the group control, every time button is pushed, the indoor UNIT No. in the group control is displayed in order.

In this time, the position of the indoor unit can be confirmed because only fan of the selected indoor unit operate.

For a group control, No. of the firstly displayed indoor unit becomes the header unit.)

3 After confirmation, push button to return the mode to the usual mode.

When button is pushed, the display disappears and the status becomes the usual stop status.

(When button is pushed the operation from the remote controller is not accepted for approx. 1 minute.)

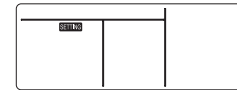

8 °C operation (More than 4 series of DI/SDI series)

Pre-heating operation can be set for cold regions where room temperature drops to below zero.

1 Push + + buttons simultaneously for 4 seconds or more when the air conditioner is not working.

After a while, the display part flashes as shown below. Check the Displayed CODE No. is [10].

- When the CODE No. is other than [10], push button to erase the display and repeat procedure from the first step. (After pushing button, operation of the remote controller is not accepted for approx. 1 minute.)

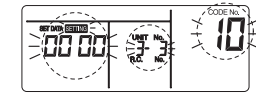

(* Display changes according to the model No. of indoor unit.)

2 Every time button is pushed, the indoor unit No. in the group control is displayed in order.

Select the indoor unit of which setup is changed. In this time, the position of the indoor unit of which setup is changed can be confirmed because fan of the selected indoor unit operate.

3 Specify CODE No. [d1] TEMP. / buttons.

4 Select SET DATA [0001] TIME / buttons.

SET DATA	8 °C Operation setting
0000	None (Factory default)
0001	8 °C Operation setting

5 Push button.

In this time, the setup finishes when the display changes from flashing to lighting.

6 Push button. (Setup is determined.)

When button is pushed, the display disappears and the status becomes the usual stop status. (When button is pushed the operation from the remote controller is not accepted for approx. 1 minute.)

9 Test run

■ Before test run

- Before turning on the power supply, carry out the following procedure.
 - 1) By using 500 V-megger, check that resistance of 1 MΩ or more exists between the terminal block 1 to 3 and the earth (grounding). If resistance of less than 1 MΩ is detected, do not run the unit.
 - 2) Check the valve of the outdoor unit being opened fully.
- To protect the compressor at activation time, leave power-ON for 12 hours or more before operating.

■ Execute a test run

Operate the unit with the wired remote controller as usual.

For the procedure of the operation, refer to the attached Owner's Manual.

A forced test run can be executed in the following procedure even if the operation stops by thermostat-OFF.

In order to prevent a serial operation, the forced test run is released after 60 minutes have passed and returns to the usual operation.

⚠ CAUTION

Do not use the forced test run for cases other than the test run because it applies an excessive load to the devices.

Wired remote controller

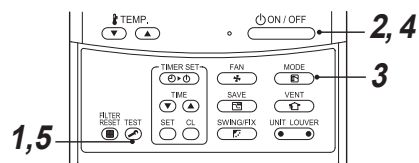

- 1 Push **TEST** button for 4 seconds or more. **[TEST]** is displayed on the display part and the selection of mode in the test mode is permitted.

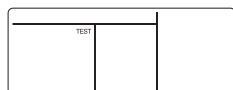

- 2 Push **ON/OFF** button.
- 3 Select the operation mode with **MODE** button, [**Cool**] or [**Heat**].
 - Do not run the air conditioner in a mode other than [**Cool**] or [**Heat**].
 - The temperature controlling function does not work during test run.
 - The detection of error is performed as usual.

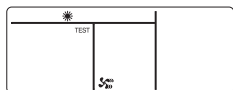

- 4 After the test run, push **ON/OFF** button to stop a test run. (Display part is same as procedure 1.)
- 5 Push **TEST** button to cancel (release from) the test run mode. ([TEST] disappears on the display and the status returns to a normal.)

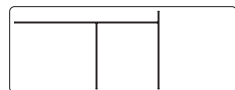

Wireless remote controller

NOTE

- Be sure to operate the unit, following the instruction manual
- Do not run the air conditioner in forced cooling mode for a long time since it overloads the air conditioner.
- Forced heating is not available for trial runs. To perform a test run, set the unit to heating mode with the remote controller. The unit might not operate in heating mode, however, depending on temperature conditions.

- 1 Hold down the **TEST** button for over 10 seconds. With a beep sound, the unit is set to the forced cooling mode.

In approximately three minutes, it is forced to start in cooling mode. Determine that cool air comes out of the unit. If the unit won't start, check the wiring.

- 2 Push the **TEST** button again (for about one second) to stop a trial run.

The upper and lower wind direction changing blades close, and the unit stops operation.

Checking remote transmission

1. Push the ON/OFF button on the remote controller to determine that it works properly.
- Pushing the TEST button once (for about one second) causes the unit to enter auto operation mode. Hold down the TEST button for over 10 seconds to begin forced cooling.
 - Even if you select cooling with a remote controller, the unit does not always perform cooling operation, depending on temperature conditions. Check the wiring and piping of the indoor and outdoor units in forced cooling mode.

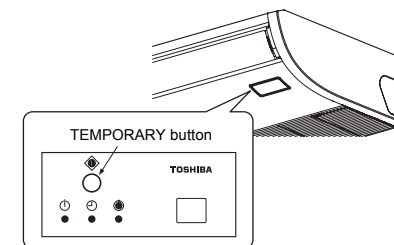

10 Maintenance

<Daily maintenance>

▼ Cleaning of air filter

- If  is displayed on the remote controller, maintain the air filter.

- 1 Push the  button to stop the operation, then turn off the circuit breaker.

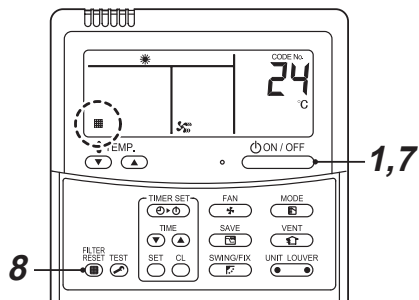

- 2 Open the air intake grille.

- Remove the screws of air intake grille fixing knob on a side of each filter.
- Slide the air intake grille fixing knobs (two positions) toward the arrow direction (OPEN), and then open the air intake grille.

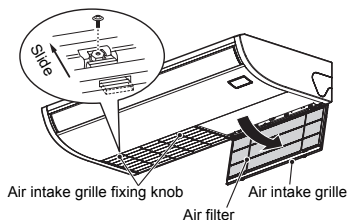

- 3 Take out air filter.

- Push the handle of the air filter, and remove the hook of the air intake grille. Pull out the air filter toward you.

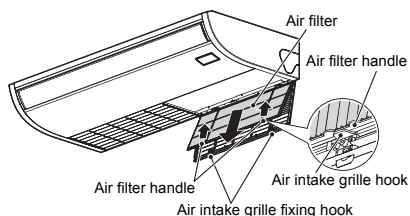

- 4 Cleaning with water or vacuum cleaner.

- If dust is heavy, wash it with tepid water including neutral detergent or water.

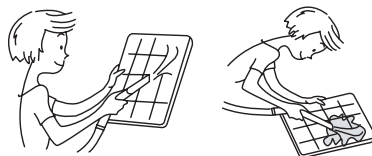



- After cleaning with water, dry it completely in the shade.

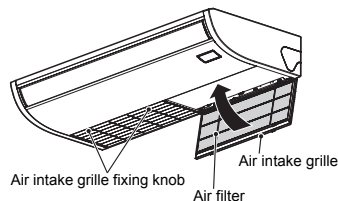

- 5 Mount the air filter.

- 6 Close the air intake grille.

- Close the air intake grille, and then fix it securely while sliding knob closed side (CLOSE).
- Fix the screws of air intake grille fixing knob on a side of each filter.



- 7 Turn on the circuit breaker, then push the  button on the remote controller to start the operation.

- 8 After cleaning, push .  display disappears.

⚠ CAUTION

- Do not start the air conditioner while leaving air filter removed.
- Push the filter reset button. ( indication will be turn off.)

▼ Periodic Maintenance

- For environmental conservation, it is strongly recommended that the indoor and outdoor units of the air conditioner in use be cleaned and maintained regularly to ensure efficient operation of the air conditioner. When the air conditioner is operated for a long time, periodic maintenance (once a year) is recommended. Furthermore, regularly check the outdoor unit for rust and scratches, and remove them or apply rustproof treatment, if necessary.

As a general rule, when an indoor unit is operated for 8 hours or more daily, clean the indoor unit and outdoor unit at least once every 3 months. Ask a professional for this cleaning / maintenance work.

Such maintenance can extend the life of the product though it involves the owner's expense.

Failure to clean the indoor and outdoor units regularly will result in poor performance, freezing, water leakage, and even compressor failure.

Inspection before maintenance

Following inspection must be carried out by a qualified installer or qualified service person.

Parts	Inspection method
Heat exchanger	Look through the air discharge port to check the part. Examine the heat exchanger if there is any clogging or damages.
Fan motor	Check if any abnormal noise can be heard.
Fan	Check if any abnormal noise can be heard.
Filter	Go to installed location and check if there are any stains or breaks on the filter.
Drain pan	Look through the air discharge port to check the part. Check if there is any clogging or drain water is polluted.

▼ Maintenance List

Part	Unit	Check (visual / auditory)	Maintenance
Heat exchanger	Indoor / outdoor	Dust / dirt clogging, scratches	Wash the heat exchanger when it is clogged.
Fan motor	Indoor / outdoor	Sound	Take appropriate measures when abnormal sound is generated.
Filter	Indoor	Dust / dirt, breakage	<ul style="list-style-type: none"> Wash the filter with water when it is contaminated. Replace it when it is damaged.
Fan	Indoor	<ul style="list-style-type: none"> Vibration, balance Dust / dirt, appearance 	<ul style="list-style-type: none"> Replace the fan when vibration or balance is terrible. Brush or wash the fan when it is contaminated.
Air intake / discharge grilles	Indoor / outdoor	Dust / dirt, scratches	Fix or replace them when they are deformed or damaged.
Drain pan	Indoor	Dust / dirt clogging, drain contamination	Clean the drain pan and check the downward slope for smooth drainage.
Ornamental panel, louvres	Indoor	Dust / dirt, scratches	Wash them when they are contaminated or apply repair coating.
Exterior	Outdoor	<ul style="list-style-type: none"> Rust, peeling of insulator Peeling / lift of coat 	Apply repair coating.

11 Troubleshooting

Confirmation and check

When an error occurred in the air conditioner, an error code and indoor UNIT No. appear on the display part of the remote controller.

The error code is only displayed during the operation. If the display disappears, operate the air conditioner according to the following "Confirmation of error log" for confirmation.

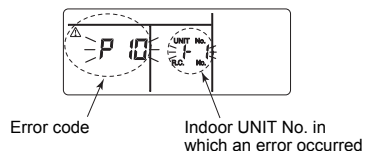

Confirmation of error log

When an error occurred on the air conditioner, the error log can be confirmed with the following procedure. (The error log is stored in memory up to 4 errors.) The log can be confirmed from both operating status and stop status.

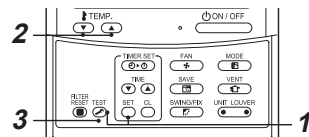

1 When **SET** and **TEST** buttons are pushed simultaneously for 4 seconds or more, the following display appears.

If **✓** is displayed, the mode enters in the error log mode.

- [01: Order of error log] is displayed in CODE No.
- [Error code] is displayed in CHECK.
- [Indoor unit address in which an error occurred] is displayed in Unit No..

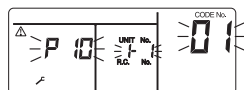

2 Every pushing of **TEMP.** button used to set temperature, the error log stored in memory is displayed in order.

The numbers in CODE No. indicate CODE No. [01] (latest) → [04] (oldest).

REQUIREMENT

Do not push **CL** button because all the error log of the indoor unit will be deleted.

3 After confirmation, push **TEST** button to return to the usual display.

Check codes and parts to be checked

Wired remote controller display	Wireless remote controller Sensor block display of receiving unit		Main defective parts	Judging device	Parts to be checked / error description	Air conditioner status
Indication	Operation Timer Ready GR GR OR	Flashing				
E01	● ● ●		No header remote controller Remote controller communication error	Remote controller	Incorrect remote controller setting --- The header remote controller has not been set (including two remote controllers). No signal can be received from the indoor unit.	*
E02	● ● ●		Remote controller transmission error	Remote controller	System interconnection wires, indoor P.C. board, remote controller --- No signal can be sent to the indoor unit.	*
E03	● ● ●		Indoor unit-remote controller regular communication error	Indoor	Remote controller, network adapter, indoor P.C. board --- No data is received from the remote controller or network adapter.	Auto-reset
E04	● ● ●		Indoor unit-outdoor unit serial communication error IPDU-CDB communication error	Indoor	System interconnection wires, indoor P.C. board, outdoor P.C. board --- Serial communication error between indoor unit and outdoor unit	Auto-reset
E08	● ● ●		Duplicated indoor addresses ★	Indoor	Indoor address setting error --- The same address as the self-address was detected.	Auto-reset
E09	● ● ●		Duplicated header remote controllers	Remote controller	Remote controller address setting error --- Two remote controllers are set as header in the double-remote controller control. (* The header indoor unit stops raising alarm and follower indoor units continue to operate.)	*
E11	● ● ●		Indoor unit-optional parts communication error	Indoor	Communication error between indoor P.C. board and optional parts	Entire stop
E18	● ● ●		Header unit follower unit regular communication error	Indoor	Indoor P.C. board --- Regular communication is not possible between header and follower indoor units or between twin header (main) and follower (sub) units.	Auto-reset
E31	● ● ●		IPDU communication error	Outdoor	Communication error between IPDU and CDB	Entire stop
F01	● ● ●	ALT	Indoor unit heat exchanger sensor (TCJ) error	Indoor	Heat exchanger sensor (TCJ), indoor P.C. board --- Open-circuit or short-circuit of the heat exchanger sensor (TCJ) was detected.	Auto-reset
F02	● ● ●	ALT	Indoor unit heat exchanger sensor (TC) error	Indoor	Heat exchanger sensor (TC), indoor P.C. board --- Open-circuit or short-circuit of the heat exchanger sensor (TC) was detected.	Auto-reset
F04	● ● ●	ALT	Outdoor unit discharge temp. sensor (TD) error	Outdoor	Outdoor temp. sensor (TD), outdoor P.C. board --- Open-circuit or short-circuit of the discharge temp. sensor was detected.	Entire stop
F06	● ● ●	ALT	Outdoor unit temp. sensor (TE/TS) error	Outdoor	Outdoor temp. sensors (TE/TS), outdoor P.C. board - Open-circuit or short-circuit of the heat exchanger temp. sensor was detected.	Entire stop
F07	● ● ●	ALT	TL sensor error	Outdoor	TL sensor may be displaced, disconnected or short-circuited.	Entire stop
F08	● ● ●	ALT	Outdoor unit outside air temp. sensor error	Outdoor	Outdoor temp. sensor (TO), outdoor P.C. board --- Open-circuit or short-circuit of the outdoor air temp. sensor was detected.	Operation continued
F10	● ● ●	ALT	Indoor unit room temp. sensor (TA) error	Indoor	Room temp. sensor (TA), indoor P.C. board --- Open-circuit or short-circuit of the room temp. sensor (TA) was detected.	Auto-reset
F12	● ● ●	ALT	TS (1) sensor error	Outdoor	TS (1) sensor may be displaced, disconnected or short-circuited.	Entire stop
F13	● ● ●	ALT	Heat sink sensor error	Outdoor	Abnormal temperature was detected by the temp. sensor of the IGBT heat sink.	Entire stop
F15	● ● ●	ALT	Temp. sensor connection error	Outdoor	Temp. sensor (TE/TS) may be connected incorrectly.	Entire stop

Wired remote controller display	Wireless remote controller Sensor block display of receiving unit		Main defective parts	Judging device	Parts to be checked / error description	Air conditioner status
	Operation Timer Ready GR GR OR	Flashing				
F29	⊙ ⊙ ●	SIM	Indoor unit, other P.C. board error	Indoor	Indoor P.C. board --- EEPROM error	Auto-reset
F31	⊙ ⊙ ○	SIM	Outdoor unit P.C. board	Outdoor	Outdoor P.C. board ---- In the case of EEPROM error.	Entire stop
H01	● ⊙ ●		Outdoor unit compressor breakdown	Outdoor	Current detect circuit, power voltage --- Minimum frequency was reached in the current releasing control or short-circuit current (Idc) after direct excitation was detected	Entire stop
H02	● ⊙ ●		Outdoor unit compressor lock	Outdoor	Compressor circuit --- Compressor lock was detected.	Entire stop
H03	● ⊙ ●		Outdoor unit current detect circuit error	Outdoor	Current detect circuit, outdoor unit P.C. board --- Abnormal current was detected in AC-CT or a phase loss was detected.	Entire stop
H04	● ⊙ ●		Case thermostat operation (1)	Outdoor	Malfunction of the case thermostat	Entire stop
H06	● ⊙ ●		Outdoor unit low-pressure system error	Outdoor	Current, high-pressure switch circuit, outdoor P.C. board --- Ps pressure sensor error was detected or low-pressure protective operation was activated.	Entire stop
L03	⊙ ● ⊙	SIM	Duplicated header indoor units ★	Indoor	Indoor address setting error --- There are two or more header units in the group.	Entire stop
L07	⊙ ● ⊙	SIM	Group line in individual indoor unit ★	Indoor	Indoor address setting error --- There is at least one group-connected indoor unit among individual indoor units.	Entire stop
L08	⊙ ● ⊙	SIM	Indoor group address not set ★	Indoor	Indoor address setting error --- Indoor address group has not been set.	Entire stop
L09	⊙ ● ⊙	SIM	Indoor unit capacity not set	Indoor	Indoor unit capacity has not been set.	Entire stop
L10	⊙ ○ ⊙	SIM	Outdoor unit P.C. board	Outdoor	In the case of outdoor P.C. board jumper wire (for service) setting error	Entire stop
L20	⊙ ○ ⊙	SIM	LAN communication error	Network adapter central control	Address setting, central control remote controller, network adapter --- Duplication of address in central control communication	Auto-reset
L29	⊙ ○ ⊙	SIM	Other outdoor unit error	Outdoor	Other outdoor unit error	Entire stop
					1) Communication error between IPDU MCU and CDB MCU 2) Abnormal temperature was detected by the heat sink temp. sensor in IGBT.	Entire stop
L30	⊙ ○ ⊙	SIM	Abnormal external input into indoor unit (interlock)	Indoor	External devices, outdoor unit P.C. board --- Abnormal stop due to incorrect external input into CN80	Entire stop
L31	⊙ ○ ⊙	SIM	Phase sequence error, etc.	Outdoor	Power supply phase sequence, outdoor unit P.C. board --- Abnormal phase sequence of the 3-phase power supply	Operation continued (thermost at OFF)
P03	⊙ ● ⊙	ALT	Outdoor unit discharge temp. error	Outdoor	An error was detected in the discharge temp. releasing control.	Entire stop
P04	⊙ ● ⊙	ALT	Outdoor unit high-pressure system error	Outdoor	High-pressure switch --- The IOL was activated or an error was detected in the high-pressure releasing control using the TE.	Entire stop
P05	⊙ ● ⊙	ALT	Open phase detected	Outdoor	The power wire may be connected incorrectly. Check open phase and voltages of the power supply.	Entire stop
P07	⊙ ● ⊙	ALT	Heat sink overheat	Outdoor	Abnormal temperature was detected by the temp. sensor of the IGBT heat sink.	Entire stop
P10	● ⊙ ⊙	ALT	Indoor unit water overflow detected	Indoor	Drain pipe, clogging of drainage, float switch circuit, indoor P.C. board --- Drainage is out of order or the float switch was activated.	Entire stop
P12	● ⊙ ⊙	ALT	The fan error of the indoor unit	Indoor	Indoor fan motor, indoor P.C. board --- Abnormal operation (over current or lock, etc.) is detected.	Entire stop

Wired remote controller display	Wireless remote controller Sensor block display of receiving unit		Main defective parts	Judging device	Parts to be checked / error description	Air conditioner status
	Operation Timer Ready GR GR OR	Flashing				
P15	⊙ ● ⊙	ALT	Gas leakage detected	Outdoor	There may be gas leakage from the pipe or connecting part. Check for gas leakage.	Entire stop
P19	⊙ ● ⊙	ALT	4-way valve error	Outdoor (Indoor)	4-way valve, indoor temp. sensors (TC/TCJ) --- An error was detected due to temperature drop of the indoor unit heat exchanger sensor when heating.	Auto-reset
P20	⊙ ● ⊙	ALT	High-pressure protective operation	Outdoor	High-pressure protection	Entire stop
P22	⊙ ● ⊙	ALT	Outdoor unit fan error	Outdoor	Outdoor unit fan motor, outdoor unit P.C. board --- An error (overcurrent, locking, etc.) was detected in the outdoor unit fan drive circuit.	Entire stop
P26	⊙ ● ⊙	ALT	Outdoor unit inverter Idc activated	Outdoor	IGBT, outdoor unit P.C. board, inverter wiring, compressor --- Short-circuit protection for compressor drive circuit devices (G-Tr/IGBT) was activated.	Entire stop
P29	⊙ ● ⊙	ALT	Outdoor unit position error	Outdoor	Outdoor unit P.C. board, high-pressure switch --- Compressor motor position error was detected.	Entire stop
P31	⊙ ● ⊙	ALT	Other indoor unit error	Indoor	Another indoor unit in the group is raising an alarm. E03/L07/L03/L08 alarm check locations and error description	Auto-reset

○ : Lighting ⊙ : Flashing ● : OFF
★ : The air conditioner automatically enters the auto-address setting mode.
ALT: When two LEDs are flashing, they flash alternately.
SIM: When two LEDs are flashing, they flash in synchronization.
Receiving unit display OR: Orange GR: Green

TOSHIBA CARRIER (THAILAND) CO.,LTD.

144 / 9 Moo 5, Bangkadi Industrial Park, Tivanon Road, Amphur Muang, Pathumthani 12000, Thailand

1114652299