

**TOSHIBA**

FILE NO. SVM-15074

SERVICE MANUAL

**AIR-CONDITIONER**

SPLIT TYPE

***RAS-3M26S3AV-E***

***RAS-3M26S3AV-A***

***RAS-3M26S3AV-TR***

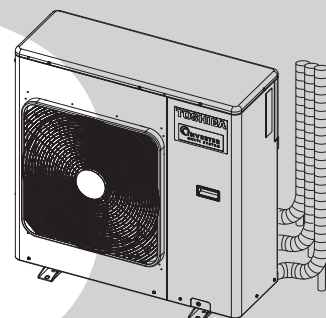

July, 2015



# CONTENTS

<b>1. SAFETY PRECAUTIONS .....</b>	<b>3</b>
<b>2. SPECIFICATIONS .....</b>	<b>5</b>
<b>3. REFRIGERANT R410A .....</b>	<b>21</b>
<b>4. CONSTRUCTION VIEWS .....</b>	<b>29</b>
<b>5. WIRING DIAGRAM .....</b>	<b>30</b>
<b>6. SPECIFICATIONS OF ELECTRICAL PARTS.....</b>	<b>34</b>
<b>7. REFRIGERANT CYCLE DIAGRAM.....</b>	<b>35</b>
<b>8. CONTROL BLOCK DIAGRAM .....</b>	<b>40</b>
<b>9. OPERATION DESCRIPTION .....</b>	<b>42</b>
<b>10. INSTALLATION PROCEDURE .....</b>	<b>51</b>
<b>11. HOW TO DIAGNOSE THE TROUBLE .....</b>	<b>60</b>
<b>12. HOW TO REPLACE THE MAIN PARTS .....</b>	<b>86</b>
<b>13. EXPLODED VIEWS AND PARTS LIST.....</b>	<b>101</b>

## 1. SAFETY PRECAUTIONS



The important contents concerned to the safety are described on the product itself and on this Service Manual. Please read this Service Manual after understanding the described items thoroughly in the following contents (Indications/Illustrated marks), and keep them.

### [Explanation of indications]

Indication	Explanation
 <b>DANGER</b>	Indicates contents assumed that an imminent danger causing a death or serious injury of the repair engineers and the third parties when an incorrect work has been executed.
 <b>WARNING</b>	Indicates possibilities assumed that a danger causing a death or serious injury of the repair engineers, the third parties, and the users due to troubles of the product after work when an incorrect work has been executed.
 <b>CAUTION</b>	Indicates contents assumed that an injury or property damage (*) may be caused on the repair engineers, the third parties, and the users due to troubles of the product after work when an incorrect work has been executed.

\* Property damage : Enlarged damage concerned to property, furniture, and domestic animal/pet

### [Explanation of illustrated marks]

Mark	Explanation
	Indicates prohibited items (Forbidden items to do) The sentences near an illustrated mark describe the concrete prohibited contents.
	Indicates mandatory items (Compulsory items to do) The sentences near an illustrated mark describe the concrete mandatory contents.
	Indicates cautions (including danger/warning) The sentences or illustration near or in an illustrated mark describe the concrete cautious contents.

### For general public use

Power supply cord of outdoor unit shall be more than 2.5 mm<sup>2</sup> (H07RN-F or 60245IEC66) polychloroprene sheathed flexible cord.

- Read this "SAFETY PRECAUTIONS" carefully before servicing.
- The precautions described below include the important items regarding safety. Observe them without fail.
- After the servicing work, perform a trial operation to check for any problem.
- Turn off the main power supply switch (or breaker) before the unit maintenance.

 **CAUTION**

### New Refrigerant Air Conditioner Installation

- **THIS AIR CONDITIONER ADOPTS THE NEW HFC REFRIGERANT (R410A) WHICH DOES NOT DESTROY OZONE LAYER.**

R410A refrigerant is apt to be affected by impurities such as water, oxidizing membrane, and oils because the working pressure of R410A refrigerant is approx. 1.6 times of refrigerant R22. Accompanied with the adoption of the new refrigerant, the refrigeration machine oil has also been changed. Therefore, during installation work, be sure that water, dust, former refrigerant, or refrigeration machine oil does not enter into the new type refrigerant R410A air conditioner circuit.

To prevent mixing of refrigerant or refrigerating machine oil, the sizes of connecting sections of charging port on main unit and installation tools are different from those used for the conventional refrigerant units.

Accordingly, special tools are required for the new refrigerant (R410A) units. For connecting pipes, use new and clean piping materials with high pressure fittings made for R410A only, so that water and/or dust does not enter. Moreover, do not use the existing piping because there are some problems with pressure fittings and possible impurities in existing piping.

---

 **CAUTION**

---

**TO DISCONNECT THE APPLIANCE FROM THE MAIN POWER SUPPLY**

A switch or circuit breaker that can disconnect all poles must be included in the fixed wiring.  
Be sure to use an approved circuit breaker or switch.

---



---

 **DANGER**

---

- **The manufacturer shall not assume any liability for the damage caused by not observing the description of this manual.**
- **Ask an authorized dealer or qualified installation professional to install/maintain the air conditioner.**  
INAPPROPRIATE SERVICING MAY RESULT IN WATER LEAKAGE, ELECTRIC SHOCK OR FIRE.
- **TURN OFF MAIN POWER SUPPLY BEFORE ATTEMPTING ANY ELECTRICAL WORK.**  
MAKE SURE ALL POWER SWITCHES ARE OFF. FAILURE TO DO SO MAY CAUSE ELECTRIC SHOCK.

---

 **DANGER: HIGH VOLTAGE**

---

The high voltage circuit is incorporated. Be careful to do the check service, as the electric shock may be caused in case of touching parts on the P.C. board by hand.

---

- **CORRECTLY CONNECT THE CONNECTING CABLE. IF THE CONNECTING CABLE IS INCORRECTLY CONNECTED, ELECTRIC PARTS MAY BE DAMAGED.**
  - **CHECK THAT THE EARTH WIRE IS NOT BROKEN OR DISCONNECTED BEFORE SERVICE AND INSTALLATION. FAILURE TO DO SO MAY CAUSE ELECTRIC SHOCK.**
  - **DO NOT INSTALL NEAR CONCENTRATIONS OF COMBUSTIBLE GAS OR GAS VAPORS. FAILURE TO FOLLOW THIS INSTRUCTION CAN RESULT IN FIRE OR EXPLOSION.**
  - **TO PREVENT THE INDOOR UNIT FROM OVERHEATING AND CAUSING A FIRE HAZARD, PLACE THE UNIT WELL AWAY (MORE THAN 2 M) FROM HEAT SOURCES SUCH AS RADIATORS, HEAT RESISTORS, FURNACE, STOVES, ETC.**
  - **WHEN MOVING THE AIR-CONDITIONER FOR INSTALLATION IN ANOTHER PLACE, BE VERY CAREFUL NOT TO ALLOW THE SPECIFIED REFRIGERANT (R410A) TO BECOME MIXED WITH ANY OTHER GASEOUS BODY INTO THE REFRIGERATION CIRCUIT. IF AIR OR ANY OTHER GAS IS MIXED IN THE REFRIGERANT, THE GAS PRESSURE IN THE REFRIGERATION CIRCUIT WILL BECOME ABNORMALLY HIGH AND IT MAY RESULT IN THE PIPE BURSTING AND POSSIBLE PERSONNEL INJURIES.**
  - **IN THE EVENT THAT THE REFRIGERANT GAS LEAKS OUT OF THE PIPE DURING THE SERVICE WORK AND THE INSTALLATION WORK, IMMEDIATELY LET FRESH AIR INTO THE ROOM. IF THE REFRIGERANT GAS IS HEATED, SUCH AS BY FIRE, GENERATION OF POISONOUS GAS MAY RESULT.**
- 

---

 **WARNING**

---

- **Do not use any refrigerant different from the one specified for complement or replacement.**  
Otherwise, abnormally high pressure may be generated in the refrigeration cycle, which may result in a failure or explosion of the product or an injury to your body.
  - **Never modify this unit by removing any of the safety guards or bypass any of the safety interlock switches.**
  - **Do not install in a place which cannot bear the weight of the unit.**  
**Personal injury and property damage can result if the unit falls.**
  - **After the installation work, confirm that refrigerant gas does not leak.**  
If refrigerant gas leaks into the room and flows near a fire source such as a cooking range, noxious gas may generate.
  - **The electrical work must be performed by a qualified electrician in accordance with the Installation Manual. Make sure the air conditioner uses an exclusive circuit.**  
An insufficient circuit capacity or inappropriate installation may cause fire.
  - **When wiring, use the specified cables and connect the terminals securely to prevent external forces applied to the cable from affecting the terminals.**
  - **Be sure to provide grounding.**  
Do not connect ground wires to gas pipes, water pipes, lightning rods or ground wires for telephone cables.
  - **Conform to the regulations of the local electric company when wiring the power supply.**  
Inappropriate grounding may cause electric shock.
-

## ⚠ CAUTION

- Exposure of unit to water or other moisture before installation may result in an electrical short.  
Do not store in a wet basement or expose to rain or water.
- Do not install in a place that can increase the vibration of the unit. Do not install in a place that can amplify the noise level of the unit or where noise or discharged air might disturb neighbors.
- To avoid personal injury, be careful when handling parts with sharp edges.
- **Perform the specified installation work to guard against an earthquake.**  
If the air conditioner is not installed appropriately, accidents may occur due to the falling unit.

## 2. SPECIFICATIONS

The indoor and outdoor units that can be used in combination are shown in the tables below.

**Table of models that can be used in combination**

Type	Outdoor unit	Combinations of indoor unit models that can be connected
Heat pump	RAS-HT G S3AV-E, -A, -TR	Refer to page 8 to 19

### NOTES

A 1-room connection is not an option for the indoor units (you cannot connect only one indoor unit).  
Be sure to connect indoor units in two or more.

### 2-1. Specifications

#### <Heat Pump Models>

#### RAS-' A & S3AV-E, -A, -TR

Unit model	Outdoor	RAS-	6% B' ? J&I9%L&Z'6% B' ? &I9%L%
		RAS-	' A & S3AV-E, -A, -TR
Cooling Capacity		(kW)	1.1
Cooling Capacity range		(kW)	1.1 ~ 1.1
Heating Capacity		(kW)	9.0
Heating Capacity range		(kW)	9.0 ~ 9.0
Power supply			220-240V 1Ph 50Hz / 220V 1Ph 60Hz
Electric characteristics	Total	Operation mode	Cooling Heating
		Running current (A)	J&I9%L&Z'6% B' ? &I9%L% F&I9%L&Z'6% B' ? &I9%L%
		Power consumption (W)	2000 2000
		Power factor (%)	95 95
		Starting current (A)	J&I9%L&Z'6% B' ? &I9%L% F&I9%L&Z'6% B' ? &I9%L%
COP	(Cooling/Heating)		H&I9%L&Z'6% B' ? &I9%L% F&I9%L&Z'6% B' ? &I9%L%
Operating noise	Outdoor (Cooling/Heating)	Full indoor units operating	48 / 49
Outdoor unit	Dimension	Height (mm)	890
		Width (mm)	900
		Depth (mm)	320
	Net weight	(kg)	72
	Compressor	Motor output (W)	2000
		Type	Twin rotary type with DC-inverter variable speed control
		Model	DA220A2T-20LD
	Fan motor output	(W)	60
Air flow rate	(m³/h)	High: 2507, Medium: 2507	
Type		Flare connection	
Piping connection	Outdoor unit	A unit liquid side/gas side	Ø6.35 / Ø12.7
		B unit liquid side/gas side	Ø6.35 / Ø12.7
		C unit liquid side/gas side	Ø6.35 / Ø9.52
	Maximum length (per unit)	(m)	25
	Maximum length (total)	(m)	70
	Maximum chargeless length	(m)	40
	Maximum height difference	(m)	15
	Name of refrigerant		R410A
Weight	(kg)	2.40	
Wiring connection	Power supply / interconnection		3 Wires : includes earth / 4 Wires : includes earth
Usable temperature range	Outdoor (Cooling/Heating)	(°C)	-10 to 46 / -15 to 24
Accessory Outdoor unit	Unit model	RAS-	' A & S3AV-E, -A, -TR
	Installation manual		1

- For performance when each indoor unit is combined with other unit, refer to the separate table.
- The specifications may be subject to change without notice for purpose of improvement.

## 2-2-1. SUMMARIES OF PRODUCT CHARACTERISTICS

### RAS-3M26S3AV-A

AS/NZS 4755.3.1.

These models supports DRM1 DRM2 DRM3.

AS/NZS 4755	DRM1 <input checked="" type="checkbox"/>	DRM2 <input checked="" type="checkbox"/>	DRM3 <input checked="" type="checkbox"/>
-------------	--	--	--

Demand response mode	Description
DRM1	Compressor off
DRM2	$E_{30m} \leq R \times 0.50 \times 0.5$
DRM3	$E_{30m} \leq R \times 0.75 \times 0.5$

\*1: E30m = total electrical energy (kWh) used by the air conditioner for all purposes (including compressors, controls and fans) over a 30 min period.

\*2: R = rated input electrical power of the air conditioner (kW) at rated capacity in the mode in which it is operating during the demand response event (i.e.cooling or heating).

### DRED installation position

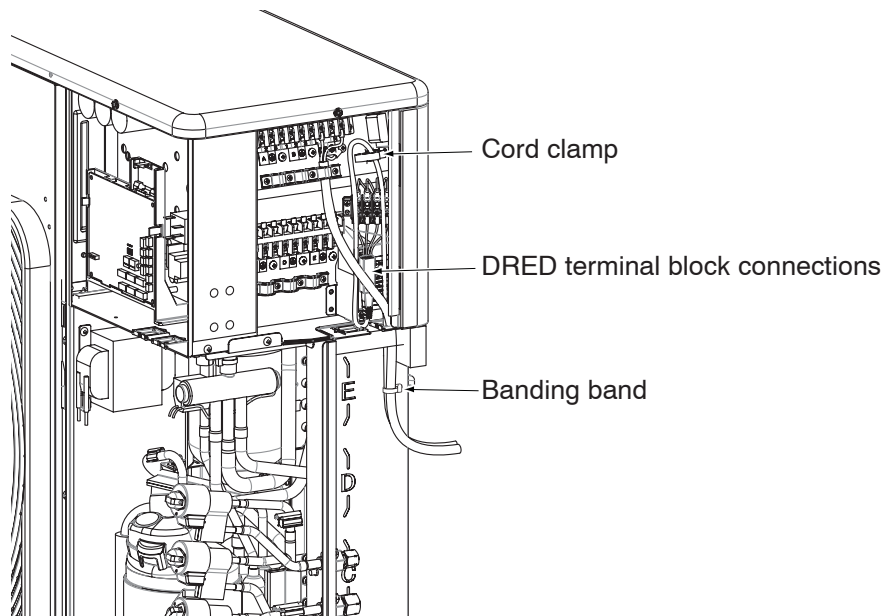

### Outline of DRED wiring

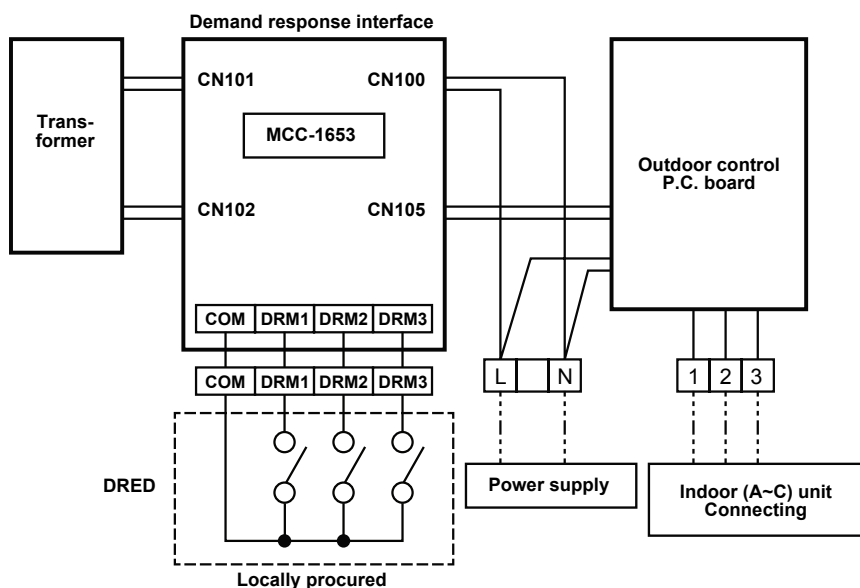

**2-2-2. SPECIFICATIONS OF ELECTRICAL PARTS**

**1. Parts for demand response (Common usage)**

No.	Parts name	Type	Specifications
1	Demand response P.C. board	MCC-1653	AC230-240V,50Hz
2	Transformer	TT-02	AC230V,50/60Hz,150mA

**2. Demand response P.C. board**

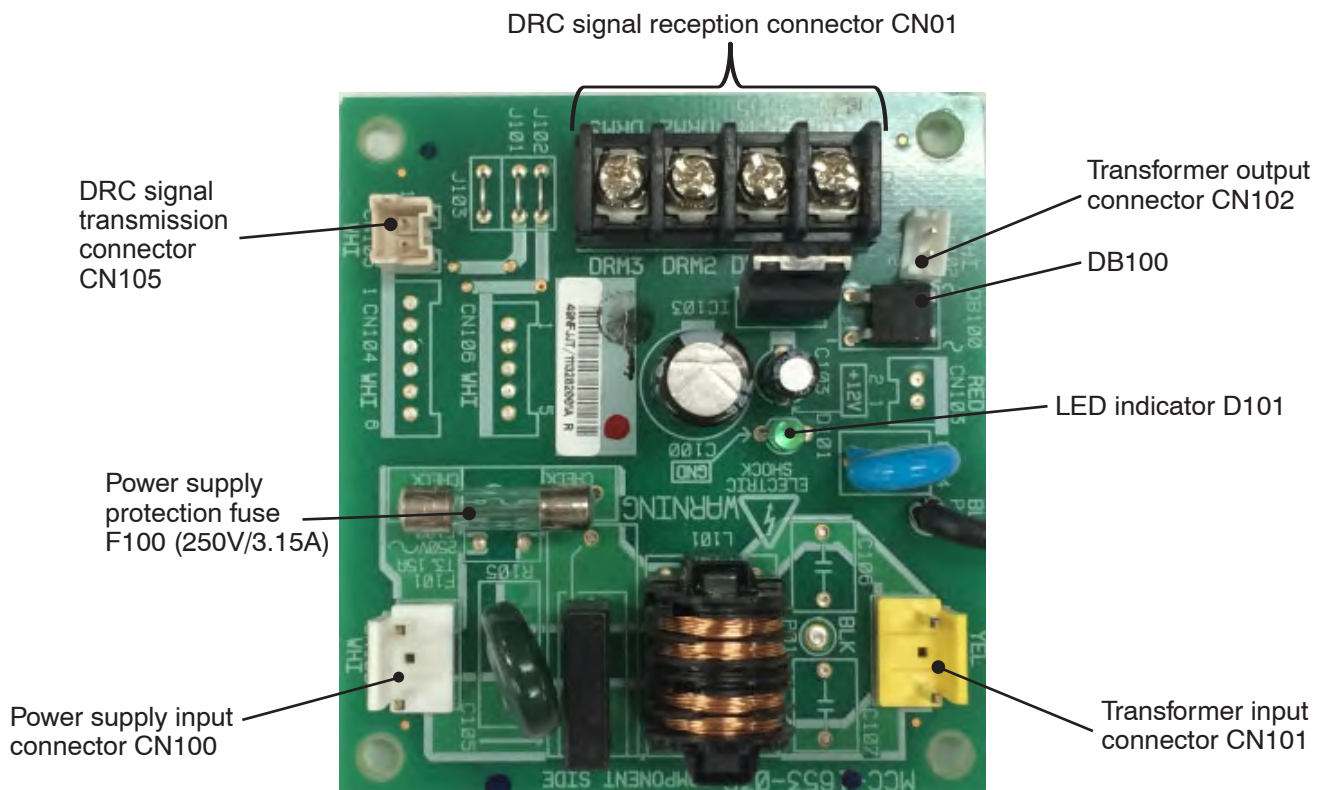

## Outdoor Unit : RAS-3M26S3AV - E,-A,-TR

## &lt;Cooling / 220V&gt;

Power supply (V)	Operating status	Indoor unit			Unit capacity (kW)			Total			Outdoor noise (dB)	
		A	B	C	A	B	C	Cooling capacity (kW)	Power consumption (W)	Operating current (A)	Sound Pressure	Sound Power
220	1 unit	07	-	-	2.00	-	-	2.0 ( 1.4 - 2.5 )	650 ( 640 - 700 )	3.84 ( 3.83 - 3.74 )	48	63
		10	-	-	2.70	-	-	2.7 ( 1.4 - 3.2 )	750 ( 640 - 950 )	4.43 ( 3.83 - 4.64 )	48	63
		13	-	-	3.70	-	-	3.7 ( 1.4 - 4.4 )	1200 ( 640 - 1520 )	6.20 ( 3.68 - 7.20 )	48	63
		16	-	-	4.50	-	-	4.5 ( 1.4 - 5.0 )	1650 ( 640 - 2000 )	7.98 ( 3.68 - 9.28 )	48	63
		18	-	-	5.00	-	-	5.0 ( 1.4 - 5.2 )	1950 ( 640 - 2100 )	9.33 ( 3.68 - 9.74 )	48	63
		22	-	-	6.00	-	-	6.0 ( 2.4 - 6.8 )	2020 ( 640 - 2500 )	9.56 ( 3.68 - 11.60 )	48	63
		24	-	-	7.10	-	-	7.1 ( 2.4 - 7.2 )	2390 ( 660 - 2960 )	11.32 ( 3.80 - 13.73 )	48	63
	2 units	07	07	-	2.00	2.00	-	4.0 ( 2.5 - 6.3 )	950 ( 640 - 1900 )	4.55 ( 3.64 - 8.81 )	48	63
		10	07	-	2.70	2.00	-	4.7 ( 2.5 - 6.3 )	1200 ( 640 - 1900 )	5.74 ( 3.64 - 8.81 )	48	63
		13	07	-	3.70	2.00	-	5.7 ( 2.6 - 6.5 )	1600 ( 660 - 2220 )	7.66 ( 3.75 - 10.30 )	48	63
		16	07	-	4.08	1.82	-	5.9 ( 2.7 - 6.6 )	1700 ( 660 - 2220 )	8.13 ( 3.75 - 10.30 )	48	63
		18	07	-	4.50	1.80	-	6.3 ( 2.9 - 6.9 )	2000 ( 670 - 2400 )	9.57 ( 3.81 - 11.13 )	48	63
		22	07	-	4.73	1.58	-	6.3 ( 2.9 - 7.1 )	2000 ( 670 - 2400 )	9.57 ( 3.81 - 11.13 )	48	63
		24	07	-	5.31	1.49	-	6.8 ( 3.0 - 7.4 )	2200 ( 690 - 2450 )	10.53 ( 3.92 - 11.36 )	48	63
		10	10	-	2.70	2.70	-	5.4 ( 2.5 - 6.3 )	1500 ( 640 - 1900 )	7.18 ( 3.64 - 8.81 )	48	63
		13	10	-	3.41	2.49	-	5.9 ( 2.7 - 6.6 )	1700 ( 660 - 2220 )	8.13 ( 3.75 - 10.30 )	48	63
		16	10	-	3.94	2.36	-	6.3 ( 2.9 - 6.9 )	2000 ( 670 - 2400 )	9.57 ( 3.81 - 11.13 )	48	63
		18	10	-	4.09	2.21	-	6.3 ( 2.9 - 7.1 )	2000 ( 670 - 2400 )	9.57 ( 3.81 - 11.13 )	48	63
		22	10	-	4.69	2.11	-	6.8 ( 3.0 - 7.4 )	2200 ( 690 - 2450 )	10.53 ( 3.92 - 11.36 )	48	63
		24	10	-	5.22	1.98	-	7.2 ( 3.2 - 7.8 )	2300 ( 700 - 2500 )	11.00 ( 3.98 - 11.60 )	48	63
		13	13	-	3.15	3.15	-	6.3 ( 2.9 - 7.1 )	2000 ( 670 - 2400 )	9.57 ( 3.81 - 11.13 )	48	63
		16	13	-	3.73	3.07	-	6.8 ( 3.0 - 7.4 )	2200 ( 690 - 2450 )	10.53 ( 3.92 - 11.36 )	48	63
		18	13	-	3.91	2.89	-	6.8 ( 3.0 - 7.4 )	2200 ( 690 - 2450 )	10.53 ( 3.92 - 11.36 )	48	63
		22	13	-	4.45	2.75	-	7.2 ( 3.2 - 7.8 )	2300 ( 700 - 2500 )	11.00 ( 3.98 - 11.60 )	48	63
		24	13	-	4.73	2.47	-	7.2 ( 3.2 - 8.4 )	2300 ( 700 - 2550 )	11.00 ( 3.98 - 11.83 )	48	63
		16	16	-	3.60	3.60	-	7.2 ( 3.2 - 7.8 )	2300 ( 700 - 2500 )	11.00 ( 3.98 - 11.60 )	48	63
		18	16	-	3.79	3.41	-	7.2 ( 3.2 - 7.8 )	2300 ( 700 - 2500 )	11.00 ( 3.98 - 11.60 )	48	63
		22	16	-	4.17	3.13	-	7.3 ( 3.2 - 8.4 )	2400 ( 700 - 2550 )	11.48 ( 3.98 - 11.83 )	48	63
		24	16	-	4.47	2.83	-	7.3 ( 3.2 - 8.4 )	2400 ( 700 - 2550 )	11.48 ( 3.98 - 11.83 )	48	63
		18	18	-	3.60	3.60	-	7.2 ( 3.2 - 8.4 )	2300 ( 700 - 2550 )	11.00 ( 3.98 - 11.83 )	48	63
22	18	-	4.04	3.36	-	7.4 ( 3.2 - 8.4 )	2400 ( 700 - 2550 )	11.48 ( 3.98 - 11.83 )	48	63		
24	18	-	4.34	3.06	-	7.4 ( 3.2 - 8.4 )	2400 ( 700 - 2550 )	11.48 ( 3.98 - 11.83 )	48	63		

• The above specification values are those under the conditions that the indoor DB/WB=27/19°C and the outdoor DB/WB=35/-°C



<Cooling / 220V> (Continued)

Power supply (V)	Operating status	Indoor unit			Unit capacity (kW)			Total			Outdoor noise (dB)	
								Cooling capacity (kW)	Power consumption (W)	Operating current (A)	Sound Pressure	Sound Power
		A	B	C	A	B	C					
220	3 units	07	07	07	2.00	2.00	2.00	6.0 ( 3.8 - 8.4 )	1400 ( 950 - 2720 )	6.70 ( 4.80 - 12.62 )	48	63
		10	07	07	2.70	2.00	2.00	6.7 ( 3.8 - 8.4 )	1660 ( 950 - 2720 )	7.94 ( 4.80 - 12.62 )	48	63
		13	07	07	3.56	1.92	1.92	7.4 ( 3.9 - 8.6 )	1975 ( 960 - 2750 )	9.45 ( 4.85 - 12.76 )	48	63
		16	07	07	3.92	1.74	1.74	7.4 ( 3.9 - 8.6 )	1975 ( 960 - 2750 )	9.45 ( 4.85 - 12.76 )	48	63
		18	07	07	4.11	1.64	1.64	7.4 ( 4.0 - 8.8 )	1975 ( 970 - 2770 )	9.45 ( 4.90 - 12.85 )	48	63
		22	07	07	4.44	1.48	1.48	7.4 ( 4.0 - 8.8 )	1975 ( 970 - 2770 )	9.45 ( 4.90 - 12.85 )	48	63
		24	07	07	4.73	1.33	1.33	7.4 ( 4.0 - 8.8 )	1975 ( 970 - 2770 )	9.45 ( 4.90 - 12.85 )	48	63
		10	10	07	2.70	2.70	2.00	7.4 ( 3.8 - 8.4 )	1850 ( 950 - 2720 )	8.85 ( 4.80 - 12.62 )	48	63
		13	10	07	3.26	2.38	1.76	7.4 ( 3.9 - 8.6 )	1975 ( 960 - 2750 )	9.45 ( 4.85 - 12.76 )	48	63
		16	10	07	3.62	2.17	1.61	7.4 ( 4.0 - 8.8 )	1975 ( 970 - 2770 )	9.45 ( 4.90 - 12.85 )	48	63
		18	10	07	3.81	2.06	1.53	7.4 ( 4.0 - 8.8 )	1975 ( 970 - 2770 )	9.45 ( 4.90 - 12.85 )	48	63
		22	10	07	4.15	1.87	1.38	7.4 ( 4.0 - 8.8 )	1975 ( 970 - 2770 )	9.45 ( 4.90 - 12.85 )	48	63
		24	10	07	4.45	1.69	1.25	7.4 ( 4.0 - 8.8 )	1975 ( 970 - 2770 )	9.45 ( 4.90 - 12.85 )	48	63
		13	13	07	2.91	2.91	1.57	7.4 ( 4.0 - 8.8 )	1975 ( 970 - 2770 )	9.45 ( 4.90 - 12.85 )	48	63
		16	13	07	3.26	2.68	1.45	7.4 ( 4.0 - 8.8 )	1975 ( 970 - 2770 )	9.45 ( 4.90 - 12.85 )	48	63
		18	13	07	3.46	2.56	1.38	7.4 ( 4.0 - 8.8 )	1975 ( 970 - 2770 )	9.45 ( 4.90 - 12.85 )	48	63
		22	13	07	3.79	2.34	1.26	7.4 ( 4.0 - 8.8 )	1975 ( 970 - 2770 )	9.45 ( 4.90 - 12.85 )	48	63
		24	13	07	4.10	2.14	1.16	7.4 ( 4.0 - 8.8 )	1975 ( 970 - 2770 )	9.45 ( 4.90 - 12.85 )	48	63
		16	16	07	3.03	3.03	1.35	7.4 ( 4.0 - 8.8 )	1975 ( 970 - 2770 )	9.45 ( 4.90 - 12.85 )	48	63
		18	16	07	3.22	2.90	1.29	7.4 ( 4.0 - 8.8 )	1975 ( 970 - 2770 )	9.45 ( 4.90 - 12.85 )	48	63
		22	16	07	3.60	2.70	1.20	7.5 ( 4.1 - 9.0 )	2000 ( 980 - 2800 )	9.57 ( 4.95 - 12.99 )	48	63
		24	16	07	3.92	2.48	1.10	7.5 ( 4.1 - 9.0 )	2000 ( 980 - 2800 )	9.57 ( 4.95 - 12.99 )	48	63
		10	10	10	2.47	2.47	2.47	7.4 ( 3.9 - 8.6 )	1975 ( 960 - 2750 )	9.45 ( 4.85 - 12.76 )	48	63
		13	10	10	3.01	2.20	2.20	7.4 ( 4.0 - 8.8 )	1975 ( 970 - 2770 )	9.45 ( 4.90 - 12.85 )	48	63
		16	10	10	3.36	2.02	2.02	7.4 ( 4.0 - 8.8 )	1975 ( 970 - 2770 )	9.45 ( 4.90 - 12.85 )	48	63
		18	10	10	3.56	1.92	1.92	7.4 ( 4.0 - 8.8 )	1975 ( 970 - 2770 )	9.45 ( 4.90 - 12.85 )	48	63
		22	10	10	3.89	1.75	1.75	7.4 ( 4.0 - 8.8 )	1975 ( 970 - 2770 )	9.45 ( 4.90 - 12.85 )	48	63
		24	10	10	4.20	1.60	1.60	7.4 ( 4.0 - 8.8 )	1975 ( 970 - 2770 )	9.45 ( 4.90 - 12.85 )	48	63
		13	13	10	2.71	2.71	1.98	7.4 ( 4.0 - 8.8 )	1975 ( 970 - 2770 )	9.45 ( 4.90 - 12.85 )	48	63
		16	13	10	3.06	2.51	1.83	7.4 ( 4.0 - 8.8 )	1975 ( 970 - 2770 )	9.45 ( 4.90 - 12.85 )	48	63
		18	13	10	3.25	2.40	1.75	7.4 ( 4.0 - 8.8 )	1975 ( 970 - 2770 )	9.45 ( 4.90 - 12.85 )	48	63
		22	13	10	3.63	2.24	1.63	7.5 ( 4.1 - 9.0 )	2000 ( 980 - 2800 )	9.57 ( 4.95 - 12.99 )	48	63
		24	13	10	3.94	2.06	1.50	7.5 ( 4.1 - 9.0 )	2000 ( 980 - 2800 )	9.57 ( 4.95 - 12.99 )	48	63
		16	16	10	2.85	2.85	1.71	7.4 ( 4.0 - 8.8 )	1975 ( 970 - 2770 )	9.45 ( 4.90 - 12.85 )	48	63
		18	16	10	3.03	2.73	1.64	7.4 ( 4.0 - 8.8 )	1975 ( 970 - 2770 )	9.45 ( 4.90 - 12.85 )	48	63
		22	16	10	3.41	2.56	1.53	7.5 ( 4.1 - 9.0 )	2000 ( 980 - 2800 )	9.57 ( 4.95 - 12.99 )	48	63
		24	16	10	3.72	2.36	1.42	7.5 ( 4.1 - 9.0 )	2000 ( 980 - 2800 )	9.57 ( 4.95 - 12.99 )	48	63
		13	13	13	2.47	2.47	2.47	7.4 ( 4.0 - 8.8 )	1975 ( 970 - 2770 )	9.45 ( 4.90 - 12.85 )	48	63
		16	13	13	2.80	2.30	2.30	7.4 ( 4.0 - 8.8 )	1975 ( 970 - 2770 )	9.45 ( 4.90 - 12.85 )	48	63
		18	13	13	2.98	2.21	2.21	7.4 ( 4.0 - 8.8 )	1975 ( 970 - 2770 )	9.45 ( 4.90 - 12.85 )	48	63
22	13	13	3.36	2.07	2.07	7.5 ( 4.1 - 9.0 )	2000 ( 980 - 2800 )	9.57 ( 4.95 - 12.99 )	48	63		
24	13	13	3.67	1.91	1.91	7.5 ( 4.1 - 9.0 )	2000 ( 980 - 2800 )	9.57 ( 4.95 - 12.99 )	48	63		
16	16	13	2.66	2.66	2.19	7.5 ( 4.1 - 9.0 )	2000 ( 980 - 2800 )	9.57 ( 4.95 - 12.99 )	48	63		
18	16	13	2.84	2.56	2.10	7.5 ( 4.1 - 9.0 )	2000 ( 980 - 2800 )	9.57 ( 4.95 - 12.99 )	48	63		
22	16	13	3.17	2.38	1.95	7.5 ( 4.1 - 9.0 )	2000 ( 980 - 2800 )	9.57 ( 4.95 - 12.99 )	48	63		
24	16	13	3.48	2.21	1.81	7.5 ( 4.1 - 9.0 )	2000 ( 980 - 2800 )	9.57 ( 4.95 - 12.99 )	48	63		
16	16	16	2.50	2.50	2.50	7.5 ( 4.1 - 9.0 )	2000 ( 980 - 2800 )	9.57 ( 4.95 - 12.99 )	48	63		
18	16	16	2.68	2.41	2.41	7.5 ( 4.1 - 9.0 )	2000 ( 980 - 2800 )	9.57 ( 4.95 - 12.99 )	48	63		
22	16	16	3.00	2.25	2.25	7.5 ( 4.1 - 9.0 )	2000 ( 980 - 2800 )	9.57 ( 4.95 - 12.99 )	48	63		

• The above specification values are those under the conditions that the indoor DB/WB=27/19°C and the outdoor DB/WB=35/-°C

## &lt;Cooling / 230V&gt;

Power supply (V)	Operating status	Indoor unit			Unit capacity (kW)			Total			Outdoor noise (dB)	
		A	B	C	A	B	C	Cooling capacity (kW)	Power consumption (W)	Operating current (A)	Sound Pressure	Sound Power
230	1 unit	07	-	-	2.00	-	-	2.0 ( 1.4 - 2.5 )	650 ( 640 - 700 )	3.67 ( 3.66 - 3.58 )	48	63
		10	-	-	2.70	-	-	2.7 ( 1.4 - 3.2 )	750 ( 640 - 950 )	4.23 ( 3.66 - 4.44 )	48	63
		13	-	-	3.70	-	-	3.7 ( 1.4 - 4.4 )	1200 ( 640 - 1520 )	5.93 ( 3.52 - 6.88 )	48	63
		16	-	-	4.50	-	-	4.5 ( 1.4 - 5.0 )	1650 ( 640 - 2000 )	7.63 ( 3.52 - 8.87 )	48	63
		18	-	-	5.00	-	-	5.0 ( 1.4 - 5.2 )	1950 ( 640 - 2100 )	8.92 ( 3.52 - 9.32 )	48	63
		22	-	-	6.00	-	-	6.0 ( 2.4 - 6.8 )	2020 ( 640 - 2500 )	9.15 ( 3.52 - 11.09 )	48	63
		24	-	-	7.10	-	-	7.1 ( 2.4 - 7.2 )	2390 ( 660 - 2960 )	10.82 ( 3.63 - 13.13 )	48	63
	2 units	07	07	-	2.00	2.00	-	4.0 ( 2.5 - 6.3 )	950 ( 640 - 1900 )	4.35 ( 3.48 - 8.43 )	48	63
		10	07	-	2.70	2.00	-	4.7 ( 2.5 - 6.3 )	1200 ( 640 - 1900 )	5.49 ( 3.48 - 8.43 )	48	63
		13	07	-	3.70	2.00	-	5.7 ( 2.6 - 6.5 )	1600 ( 660 - 2220 )	7.32 ( 3.59 - 9.85 )	48	63
		16	07	-	4.08	1.82	-	5.9 ( 2.7 - 6.6 )	1700 ( 660 - 2220 )	7.78 ( 3.59 - 9.85 )	48	63
		18	07	-	4.50	1.80	-	6.3 ( 2.9 - 6.9 )	2000 ( 670 - 2400 )	9.15 ( 3.64 - 10.65 )	48	63
		22	07	-	4.73	1.58	-	6.3 ( 2.9 - 7.1 )	2000 ( 670 - 2400 )	9.15 ( 3.64 - 10.65 )	48	63
		24	07	-	5.31	1.49	-	6.8 ( 3.0 - 7.4 )	2200 ( 690 - 2450 )	10.07 ( 3.75 - 10.87 )	48	63
		10	10	-	2.70	2.70	-	5.4 ( 2.5 - 6.3 )	1500 ( 640 - 1900 )	6.86 ( 3.48 - 8.43 )	48	63
		13	10	-	3.41	2.49	-	5.9 ( 2.7 - 6.6 )	1700 ( 660 - 2220 )	7.78 ( 3.59 - 9.85 )	48	63
		16	10	-	3.94	2.36	-	6.3 ( 2.9 - 6.9 )	2000 ( 670 - 2400 )	9.15 ( 3.64 - 10.65 )	48	63
		18	10	-	4.09	2.21	-	6.3 ( 2.9 - 7.1 )	2000 ( 670 - 2400 )	9.15 ( 3.64 - 10.65 )	48	63
		22	10	-	4.69	2.11	-	6.8 ( 3.0 - 7.4 )	2200 ( 690 - 2450 )	10.07 ( 3.75 - 10.87 )	48	63
		24	10	-	5.22	1.98	-	7.2 ( 3.2 - 7.8 )	2300 ( 700 - 2500 )	10.53 ( 3.80 - 11.09 )	48	63
		13	13	-	3.15	3.15	-	6.3 ( 2.9 - 7.1 )	2000 ( 670 - 2400 )	9.15 ( 3.64 - 10.65 )	48	63
		16	13	-	3.73	3.07	-	6.8 ( 3.0 - 7.4 )	2200 ( 690 - 2450 )	10.07 ( 3.75 - 10.87 )	48	63
		18	13	-	3.91	2.89	-	6.8 ( 3.0 - 7.4 )	2200 ( 690 - 2450 )	10.07 ( 3.75 - 10.87 )	48	63
		22	13	-	4.45	2.75	-	7.2 ( 3.2 - 7.8 )	2300 ( 700 - 2500 )	10.53 ( 3.80 - 11.09 )	48	63
		24	13	-	4.73	2.47	-	7.2 ( 3.2 - 8.4 )	2300 ( 700 - 2550 )	10.53 ( 3.80 - 11.31 )	48	63
		16	16	-	3.60	3.60	-	7.2 ( 3.2 - 7.8 )	2300 ( 700 - 2500 )	10.53 ( 3.80 - 11.09 )	48	63
		18	16	-	3.79	3.41	-	7.2 ( 3.2 - 7.8 )	2300 ( 700 - 2500 )	10.53 ( 3.80 - 11.09 )	48	63
		22	16	-	4.17	3.13	-	7.3 ( 3.2 - 8.4 )	2400 ( 700 - 2550 )	10.98 ( 3.80 - 11.31 )	48	63
24	16	-	4.47	2.83	-	7.3 ( 3.2 - 8.4 )	2400 ( 700 - 2550 )	10.98 ( 3.80 - 11.31 )	48	63		
18	18	-	3.60	3.60	-	7.2 ( 3.2 - 8.4 )	2300 ( 700 - 2550 )	10.53 ( 3.80 - 11.31 )	48	63		
22	18	-	4.04	3.36	-	7.4 ( 3.2 - 8.4 )	2400 ( 700 - 2550 )	10.98 ( 3.80 - 11.31 )	48	63		
24	18	-	4.34	3.06	-	7.4 ( 3.2 - 8.4 )	2400 ( 700 - 2550 )	10.98 ( 3.80 - 11.31 )	48	63		

• The above specification values are those under the conditions that the indoor DB/WB=27/19°C and the outdoor DB/WB=35/-°C

<Cooling / 230V> (Continued)

Power supply (V)	Operating status	Indoor unit			Unit capacity (kW)			Total			Outdoor noise (dB)	
								Cooling capacity (kW)	Power consumption (W)	Operating current (A)	Sound Pressure	Sound Power
		A	B	C	A	B	C					
230	3 units	07	07	07	2.00	2.00	2.00	6.0 ( 3.8 - 8.4 )	1400 ( 950 - 2720 )	6.41 ( 4.59 - 12.07 )	48	63
		10	07	07	2.70	2.00	2.00	6.7 ( 3.8 - 8.4 )	1660 ( 950 - 2720 )	7.60 ( 4.59 - 12.07 )	48	63
		13	07	07	3.56	1.92	1.92	7.4 ( 3.9 - 8.6 )	1975 ( 960 - 2750 )	9.04 ( 4.64 - 12.20 )	48	63
		16	07	07	3.92	1.74	1.74	7.4 ( 3.9 - 8.6 )	1975 ( 960 - 2750 )	9.04 ( 4.64 - 12.20 )	48	63
		18	07	07	4.11	1.64	1.64	7.4 ( 4.0 - 8.8 )	1975 ( 970 - 2770 )	9.04 ( 4.69 - 12.29 )	48	63
		22	07	07	4.44	1.48	1.48	7.4 ( 4.0 - 8.8 )	1975 ( 970 - 2770 )	9.04 ( 4.69 - 12.29 )	48	63
		24	07	07	4.73	1.33	1.33	7.4 ( 4.0 - 8.8 )	1975 ( 970 - 2770 )	9.04 ( 4.69 - 12.29 )	48	63
		10	10	07	2.70	2.70	2.00	7.4 ( 3.8 - 8.4 )	1850 ( 950 - 2720 )	8.47 ( 4.59 - 12.07 )	48	63
		13	10	07	3.26	2.38	1.76	7.4 ( 3.9 - 8.6 )	1975 ( 960 - 2750 )	9.04 ( 4.64 - 12.20 )	48	63
		16	10	07	3.62	2.17	1.61	7.4 ( 4.0 - 8.8 )	1975 ( 970 - 2770 )	9.04 ( 4.69 - 12.29 )	48	63
		18	10	07	3.81	2.06	1.53	7.4 ( 4.0 - 8.8 )	1975 ( 970 - 2770 )	9.04 ( 4.69 - 12.29 )	48	63
		22	10	07	4.15	1.87	1.38	7.4 ( 4.0 - 8.8 )	1975 ( 970 - 2770 )	9.04 ( 4.69 - 12.29 )	48	63
		24	10	07	4.45	1.69	1.25	7.4 ( 4.0 - 8.8 )	1975 ( 970 - 2770 )	9.04 ( 4.69 - 12.29 )	48	63
		13	13	07	2.91	2.91	1.57	7.4 ( 4.0 - 8.8 )	1975 ( 970 - 2770 )	9.04 ( 4.69 - 12.29 )	48	63
		16	13	07	3.26	2.68	1.45	7.4 ( 4.0 - 8.8 )	1975 ( 970 - 2770 )	9.04 ( 4.69 - 12.29 )	48	63
		18	13	07	3.46	2.56	1.38	7.4 ( 4.0 - 8.8 )	1975 ( 970 - 2770 )	9.04 ( 4.69 - 12.29 )	48	63
		22	13	07	3.79	2.34	1.26	7.4 ( 4.0 - 8.8 )	1975 ( 970 - 2770 )	9.04 ( 4.69 - 12.29 )	48	63
		24	13	07	4.10	2.14	1.16	7.4 ( 4.0 - 8.8 )	1975 ( 970 - 2770 )	9.04 ( 4.69 - 12.29 )	48	63
		16	16	07	3.03	3.03	1.35	7.4 ( 4.0 - 8.8 )	1975 ( 970 - 2770 )	9.04 ( 4.69 - 12.29 )	48	63
		18	16	07	3.22	2.90	1.29	7.4 ( 4.0 - 8.8 )	1975 ( 970 - 2770 )	9.04 ( 4.69 - 12.29 )	48	63
		22	16	07	3.60	2.70	1.20	7.5 ( 4.1 - 9.0 )	2000 ( 980 - 2800 )	9.15 ( 4.73 - 12.42 )	48	63
		24	16	07	3.92	2.48	1.10	7.5 ( 4.1 - 9.0 )	2000 ( 980 - 2800 )	9.15 ( 4.73 - 12.42 )	48	63
		10	10	10	2.47	2.47	2.47	7.4 ( 3.9 - 8.6 )	1975 ( 960 - 2750 )	9.04 ( 4.64 - 12.20 )	48	63
		13	10	10	3.01	2.20	2.20	7.4 ( 4.0 - 8.8 )	1975 ( 970 - 2770 )	9.04 ( 4.69 - 12.29 )	48	63
		16	10	10	3.36	2.02	2.02	7.4 ( 4.0 - 8.8 )	1975 ( 970 - 2770 )	9.04 ( 4.69 - 12.29 )	48	63
		18	10	10	3.56	1.92	1.92	7.4 ( 4.0 - 8.8 )	1975 ( 970 - 2770 )	9.04 ( 4.69 - 12.29 )	48	63
		22	10	10	3.89	1.75	1.75	7.4 ( 4.0 - 8.8 )	1975 ( 970 - 2770 )	9.04 ( 4.69 - 12.29 )	48	63
		24	10	10	4.20	1.60	1.60	7.4 ( 4.0 - 8.8 )	1975 ( 970 - 2770 )	9.04 ( 4.69 - 12.29 )	48	63
		13	13	10	2.71	2.71	1.98	7.4 ( 4.0 - 8.8 )	1975 ( 970 - 2770 )	9.04 ( 4.69 - 12.29 )	48	63
		16	13	10	3.06	2.51	1.83	7.4 ( 4.0 - 8.8 )	1975 ( 970 - 2770 )	9.04 ( 4.69 - 12.29 )	48	63
		18	13	10	3.25	2.40	1.75	7.4 ( 4.0 - 8.8 )	1975 ( 970 - 2770 )	9.04 ( 4.69 - 12.29 )	48	63
		22	13	10	3.63	2.24	1.63	7.5 ( 4.1 - 9.0 )	2000 ( 980 - 2800 )	9.15 ( 4.73 - 12.42 )	48	63
		24	13	10	3.94	2.06	1.50	7.5 ( 4.1 - 9.0 )	2000 ( 980 - 2800 )	9.15 ( 4.73 - 12.42 )	48	63
		16	16	10	2.85	2.85	1.71	7.4 ( 4.0 - 8.8 )	1975 ( 970 - 2770 )	9.04 ( 4.69 - 12.29 )	48	63
		18	16	10	3.03	2.73	1.64	7.4 ( 4.0 - 8.8 )	1975 ( 970 - 2770 )	9.04 ( 4.69 - 12.29 )	48	63
		22	16	10	3.41	2.56	1.53	7.5 ( 4.1 - 9.0 )	2000 ( 980 - 2800 )	9.15 ( 4.73 - 12.42 )	48	63
		24	16	10	3.72	2.36	1.42	7.5 ( 4.1 - 9.0 )	2000 ( 980 - 2800 )	9.15 ( 4.73 - 12.42 )	48	63
		13	13	13	2.47	2.47	2.47	7.4 ( 4.0 - 8.8 )	1975 ( 970 - 2770 )	9.04 ( 4.69 - 12.29 )	48	63
		16	13	13	2.80	2.30	2.30	7.4 ( 4.0 - 8.8 )	1975 ( 970 - 2770 )	9.04 ( 4.69 - 12.29 )	48	63
		18	13	13	2.98	2.21	2.21	7.4 ( 4.0 - 8.8 )	1975 ( 970 - 2770 )	9.04 ( 4.69 - 12.29 )	48	63
		22	13	13	3.36	2.07	2.07	7.5 ( 4.1 - 9.0 )	2000 ( 980 - 2800 )	9.15 ( 4.73 - 12.42 )	48	63
		24	13	13	3.67	1.91	1.91	7.5 ( 4.1 - 9.0 )	2000 ( 980 - 2800 )	9.15 ( 4.73 - 12.42 )	48	63
16	16	13	2.66	2.66	2.19	7.5 ( 4.1 - 9.0 )	2000 ( 980 - 2800 )	9.15 ( 4.73 - 12.42 )	48	63		
18	16	13	2.84	2.56	2.10	7.5 ( 4.1 - 9.0 )	2000 ( 980 - 2800 )	9.15 ( 4.73 - 12.42 )	48	63		
22	16	13	3.17	2.38	1.95	7.5 ( 4.1 - 9.0 )	2000 ( 980 - 2800 )	9.15 ( 4.73 - 12.42 )	48	63		
24	16	13	3.48	2.21	1.81	7.5 ( 4.1 - 9.0 )	2000 ( 980 - 2800 )	9.15 ( 4.73 - 12.42 )	48	63		
16	16	16	2.50	2.50	2.50	7.5 ( 4.1 - 9.0 )	2000 ( 980 - 2800 )	9.15 ( 4.73 - 12.42 )	48	63		
18	16	16	2.68	2.41	2.41	7.5 ( 4.1 - 9.0 )	2000 ( 980 - 2800 )	9.15 ( 4.73 - 12.42 )	48	63		
22	16	16	3.00	2.25	2.25	7.5 ( 4.1 - 9.0 )	2000 ( 980 - 2800 )	9.15 ( 4.73 - 12.42 )	48	63		

• The above specification values are those under the conditions that the indoor DB/WB=27/19°C and the outdoor DB/WB=35/-°C

## &lt;Cooling / 240V&gt;

Power supply (V)	Operating status	Indoor unit			Unit capacity (kW)			Total			Outdoor noise (dB)		
		A	B	C	A	B	C	Cooling capacity (kW)	Power consumption (W)	Operating current (A)	Sound Pressure	Sound Power	
240	1 unit	07	-	-	2.00	-	-	2.0 ( 1.4 - 2.5 )	650 ( 640 - 700 )	3.52 ( 3.51 - 3.43 )	48	63	
		10	-	-	2.70	-	-	2.7 ( 1.4 - 3.2 )	750 ( 640 - 950 )	4.06 ( 3.51 - 4.26 )	48	63	
		13	-	-	3.70	-	-	3.7 ( 1.4 - 4.4 )	1200 ( 640 - 1520 )	5.68 ( 3.38 - 6.60 )	48	63	
		16	-	-	4.50	-	-	4.5 ( 1.4 - 5.0 )	1650 ( 640 - 2000 )	7.31 ( 3.38 - 8.50 )	48	63	
		18	-	-	5.00	-	-	5.0 ( 1.4 - 5.2 )	1950 ( 640 - 2100 )	8.55 ( 3.38 - 8.93 )	48	63	
		22	-	-	6.00	-	-	6.0 ( 2.4 - 6.8 )	2020 ( 640 - 2500 )	8.77 ( 3.38 - 10.63 )	48	63	
		24	-	-	7.10	-	-	7.1 ( 2.4 - 7.2 )	2390 ( 660 - 2960 )	10.37 ( 3.48 - 12.59 )	48	63	
	2 units	07	07	-	-	2.00	2.00	-	4.0 ( 2.5 - 6.3 )	950 ( 640 - 1900 )	4.17 ( 3.33 - 8.08 )	48	63
		10	07	-	-	2.70	2.00	-	4.7 ( 2.5 - 6.3 )	1200 ( 640 - 1900 )	5.26 ( 3.33 - 8.08 )	48	63
		13	07	-	-	3.70	2.00	-	5.7 ( 2.6 - 6.5 )	1600 ( 660 - 2220 )	7.02 ( 3.44 - 9.44 )	48	63
		16	07	-	-	4.08	1.82	-	5.9 ( 2.7 - 6.6 )	1700 ( 660 - 2220 )	7.46 ( 3.44 - 9.44 )	48	63
		18	07	-	-	4.50	1.80	-	6.3 ( 2.9 - 6.9 )	2000 ( 670 - 2400 )	8.77 ( 3.49 - 10.20 )	48	63
		22	07	-	-	4.73	1.58	-	6.3 ( 2.9 - 7.1 )	2000 ( 670 - 2400 )	8.77 ( 3.49 - 10.20 )	48	63
		24	07	-	-	5.31	1.49	-	6.8 ( 3.0 - 7.4 )	2200 ( 690 - 2450 )	9.65 ( 3.59 - 10.42 )	48	63
		10	10	-	-	2.70	2.70	-	5.4 ( 2.5 - 6.3 )	1500 ( 640 - 1900 )	6.58 ( 3.33 - 8.08 )	48	63
		13	10	-	-	3.41	2.49	-	5.9 ( 2.7 - 6.6 )	1700 ( 660 - 2220 )	7.46 ( 3.44 - 9.44 )	48	63
		16	10	-	-	3.94	2.36	-	6.3 ( 2.9 - 6.9 )	2000 ( 670 - 2400 )	8.77 ( 3.49 - 10.20 )	48	63
		18	10	-	-	4.09	2.21	-	6.3 ( 2.9 - 7.1 )	2000 ( 670 - 2400 )	8.77 ( 3.49 - 10.20 )	48	63
		22	10	-	-	4.69	2.11	-	6.8 ( 3.0 - 7.4 )	2200 ( 690 - 2450 )	9.65 ( 3.59 - 10.42 )	48	63
		24	10	-	-	5.22	1.98	-	7.2 ( 3.2 - 7.8 )	2300 ( 700 - 2500 )	10.09 ( 3.65 - 10.63 )	48	63
		13	13	-	-	3.15	3.15	-	6.3 ( 2.9 - 7.1 )	2000 ( 670 - 2400 )	8.77 ( 3.49 - 10.20 )	48	63
		16	13	-	-	3.73	3.07	-	6.8 ( 3.0 - 7.4 )	2200 ( 690 - 2450 )	9.65 ( 3.59 - 10.42 )	48	63
		18	13	-	-	3.91	2.89	-	6.8 ( 3.0 - 7.4 )	2200 ( 690 - 2450 )	9.65 ( 3.59 - 10.42 )	48	63
		22	13	-	-	4.45	2.75	-	7.2 ( 3.2 - 7.8 )	2300 ( 700 - 2500 )	10.09 ( 3.65 - 10.63 )	48	63
		24	13	-	-	4.73	2.47	-	7.2 ( 3.2 - 8.4 )	2300 ( 700 - 2550 )	10.09 ( 3.65 - 10.84 )	48	63
		16	16	-	-	3.60	3.60	-	7.2 ( 3.2 - 7.8 )	2300 ( 700 - 2500 )	10.09 ( 3.65 - 10.63 )	48	63
		18	16	-	-	3.79	3.41	-	7.2 ( 3.2 - 7.8 )	2300 ( 700 - 2500 )	10.09 ( 3.65 - 10.63 )	48	63
		22	16	-	-	4.17	3.13	-	7.3 ( 3.2 - 8.4 )	2400 ( 700 - 2550 )	10.53 ( 3.65 - 10.84 )	48	63
		24	16	-	-	4.47	2.83	-	7.3 ( 3.2 - 8.4 )	2400 ( 700 - 2550 )	10.53 ( 3.65 - 10.84 )	48	63
		18	18	-	-	3.60	3.60	-	7.2 ( 3.2 - 8.4 )	2300 ( 700 - 2550 )	10.09 ( 3.65 - 10.84 )	48	63
22		18	-	-	4.04	3.36	-	7.4 ( 3.2 - 8.4 )	2400 ( 700 - 2550 )	10.53 ( 3.65 - 10.84 )	48	63	
24		18	-	-	4.34	3.06	-	7.4 ( 3.2 - 8.4 )	2400 ( 700 - 2550 )	10.53 ( 3.65 - 10.84 )	48	63	

• The above specification values are those under the conditions that the indoor DB/WB=27/19°C and the outdoor DB/WB=35/-°C

## &lt;Cooling / 240V&gt; (Continued)

Power supply (V)	Operating status	Indoor unit			Unit capacity (kW)			Total			Outdoor noise (dB)	
								Cooling capacity (kW)	Power consumption (W)	Operating current (A)	Sound Pressure	Sound Power
		A	B	C	A	B	C					
240	3 units	07	07	07	2.00	2.00	2.00	6.0 ( 3.8 - 8.4 )	1400 ( 950 - 2720 )	6.14 ( 4.40 - 11.56 )	48	63
		10	07	07	2.70	2.00	2.00	6.7 ( 3.8 - 8.4 )	1660 ( 950 - 2720 )	7.28 ( 4.40 - 11.56 )	48	63
		13	07	07	3.56	1.92	1.92	7.4 ( 3.9 - 8.6 )	1975 ( 960 - 2750 )	8.66 ( 4.44 - 11.69 )	48	63
		16	07	07	3.92	1.74	1.74	7.4 ( 3.9 - 8.6 )	1975 ( 960 - 2750 )	8.66 ( 4.44 - 11.69 )	48	63
		18	07	07	4.11	1.64	1.64	7.4 ( 4.0 - 8.8 )	1975 ( 970 - 2770 )	8.66 ( 4.49 - 11.78 )	48	63
		22	07	07	4.44	1.48	1.48	7.4 ( 4.0 - 8.8 )	1975 ( 970 - 2770 )	8.66 ( 4.49 - 11.78 )	48	63
		24	07	07	4.73	1.33	1.33	7.4 ( 4.0 - 8.8 )	1975 ( 970 - 2770 )	8.66 ( 4.49 - 11.78 )	48	63
		10	10	07	2.70	2.70	2.00	7.4 ( 3.8 - 8.4 )	1850 ( 950 - 2720 )	8.11 ( 4.40 - 11.56 )	48	63
		13	10	07	3.26	2.38	1.76	7.4 ( 3.9 - 8.6 )	1975 ( 960 - 2750 )	8.66 ( 4.44 - 11.69 )	48	63
		16	10	07	3.62	2.17	1.61	7.4 ( 4.0 - 8.8 )	1975 ( 970 - 2770 )	8.66 ( 4.49 - 11.78 )	48	63
		18	10	07	3.81	2.06	1.53	7.4 ( 4.0 - 8.8 )	1975 ( 970 - 2770 )	8.66 ( 4.49 - 11.78 )	48	63
		22	10	07	4.15	1.87	1.38	7.4 ( 4.0 - 8.8 )	1975 ( 970 - 2770 )	8.66 ( 4.49 - 11.78 )	48	63
		24	10	07	4.45	1.69	1.25	7.4 ( 4.0 - 8.8 )	1975 ( 970 - 2770 )	8.66 ( 4.49 - 11.78 )	48	63
		13	13	07	2.91	2.91	1.57	7.4 ( 4.0 - 8.8 )	1975 ( 970 - 2770 )	8.66 ( 4.49 - 11.78 )	48	63
		16	13	07	3.26	2.68	1.45	7.4 ( 4.0 - 8.8 )	1975 ( 970 - 2770 )	8.66 ( 4.49 - 11.78 )	48	63
		18	13	07	3.46	2.56	1.38	7.4 ( 4.0 - 8.8 )	1975 ( 970 - 2770 )	8.66 ( 4.49 - 11.78 )	48	63
		22	13	07	3.79	2.34	1.26	7.4 ( 4.0 - 8.8 )	1975 ( 970 - 2770 )	8.66 ( 4.49 - 11.78 )	48	63
		24	13	07	4.10	2.14	1.16	7.4 ( 4.0 - 8.8 )	1975 ( 970 - 2770 )	8.66 ( 4.49 - 11.78 )	48	63
		16	16	07	3.03	3.03	1.35	7.4 ( 4.0 - 8.8 )	1975 ( 970 - 2770 )	8.66 ( 4.49 - 11.78 )	48	63
		18	16	07	3.22	2.90	1.29	7.4 ( 4.0 - 8.8 )	1975 ( 970 - 2770 )	8.66 ( 4.49 - 11.78 )	48	63
		22	16	07	3.60	2.70	1.20	7.5 ( 4.1 - 9.0 )	2000 ( 980 - 2800 )	8.77 ( 4.54 - 11.90 )	48	63
		24	16	07	3.92	2.48	1.10	7.5 ( 4.1 - 9.0 )	2000 ( 980 - 2800 )	8.77 ( 4.54 - 11.90 )	48	63
		10	10	10	2.47	2.47	2.47	7.4 ( 3.9 - 8.6 )	1975 ( 960 - 2750 )	8.66 ( 4.44 - 11.69 )	48	63
		13	10	10	3.01	2.20	2.20	7.4 ( 4.0 - 8.8 )	1975 ( 970 - 2770 )	8.66 ( 4.49 - 11.78 )	48	63
		16	10	10	3.36	2.02	2.02	7.4 ( 4.0 - 8.8 )	1975 ( 970 - 2770 )	8.66 ( 4.49 - 11.78 )	48	63
		18	10	10	3.56	1.92	1.92	7.4 ( 4.0 - 8.8 )	1975 ( 970 - 2770 )	8.66 ( 4.49 - 11.78 )	48	63
		22	10	10	3.89	1.75	1.75	7.4 ( 4.0 - 8.8 )	1975 ( 970 - 2770 )	8.66 ( 4.49 - 11.78 )	48	63
		24	10	10	4.20	1.60	1.60	7.4 ( 4.0 - 8.8 )	1975 ( 970 - 2770 )	8.66 ( 4.49 - 11.78 )	48	63
		13	13	10	2.71	2.71	1.98	7.4 ( 4.0 - 8.8 )	1975 ( 970 - 2770 )	8.66 ( 4.49 - 11.78 )	48	63
		16	13	10	3.06	2.51	1.83	7.4 ( 4.0 - 8.8 )	1975 ( 970 - 2770 )	8.66 ( 4.49 - 11.78 )	48	63
		18	13	10	3.25	2.40	1.75	7.4 ( 4.0 - 8.8 )	1975 ( 970 - 2770 )	8.66 ( 4.49 - 11.78 )	48	63
		22	13	10	3.63	2.24	1.63	7.5 ( 4.1 - 9.0 )	2000 ( 980 - 2800 )	8.77 ( 4.54 - 11.90 )	48	63
		24	13	10	3.94	2.06	1.50	7.5 ( 4.1 - 9.0 )	2000 ( 980 - 2800 )	8.77 ( 4.54 - 11.90 )	48	63
		16	16	10	2.85	2.85	1.71	7.4 ( 4.0 - 8.8 )	1975 ( 970 - 2770 )	8.66 ( 4.49 - 11.78 )	48	63
		18	16	10	3.03	2.73	1.64	7.4 ( 4.0 - 8.8 )	1975 ( 970 - 2770 )	8.66 ( 4.49 - 11.78 )	48	63
		22	16	10	3.41	2.56	1.53	7.5 ( 4.1 - 9.0 )	2000 ( 980 - 2800 )	8.77 ( 4.54 - 11.90 )	48	63
		24	16	10	3.72	2.36	1.42	7.5 ( 4.1 - 9.0 )	2000 ( 980 - 2800 )	8.77 ( 4.54 - 11.90 )	48	63
		13	13	13	2.47	2.47	2.47	7.4 ( 4.0 - 8.8 )	1975 ( 970 - 2770 )	8.66 ( 4.49 - 11.78 )	48	63
		16	13	13	2.80	2.30	2.30	7.4 ( 4.0 - 8.8 )	1975 ( 970 - 2770 )	8.66 ( 4.49 - 11.78 )	48	63
		18	13	13	2.98	2.21	2.21	7.4 ( 4.0 - 8.8 )	1975 ( 970 - 2770 )	8.66 ( 4.49 - 11.78 )	48	63
		22	13	13	3.36	2.07	2.07	7.5 ( 4.1 - 9.0 )	2000 ( 980 - 2800 )	8.77 ( 4.54 - 11.90 )	48	63
		24	13	13	3.67	1.91	1.91	7.5 ( 4.1 - 9.0 )	2000 ( 980 - 2800 )	8.77 ( 4.54 - 11.90 )	48	63
16	16	13	2.66	2.66	2.19	7.5 ( 4.1 - 9.0 )	2000 ( 980 - 2800 )	8.77 ( 4.54 - 11.90 )	48	63		
18	16	13	2.84	2.56	2.10	7.5 ( 4.1 - 9.0 )	2000 ( 980 - 2800 )	8.77 ( 4.54 - 11.90 )	48	63		
22	16	13	3.17	2.38	1.95	7.5 ( 4.1 - 9.0 )	2000 ( 980 - 2800 )	8.77 ( 4.54 - 11.90 )	48	63		
24	16	13	3.48	2.21	1.81	7.5 ( 4.1 - 9.0 )	2000 ( 980 - 2800 )	8.77 ( 4.54 - 11.90 )	48	63		
16	16	16	2.50	2.50	2.50	7.5 ( 4.1 - 9.0 )	2000 ( 980 - 2800 )	8.77 ( 4.54 - 11.90 )	48	63		
18	16	16	2.68	2.41	2.41	7.5 ( 4.1 - 9.0 )	2000 ( 980 - 2800 )	8.77 ( 4.54 - 11.90 )	48	63		
22	16	16	3.00	2.25	2.25	7.5 ( 4.1 - 9.0 )	2000 ( 980 - 2800 )	8.77 ( 4.54 - 11.90 )	48	63		

• The above specification values are those under the conditions that the indoor DB/WB=27/19°C and the outdoor DB/WB=35/-°C

**Outdoor Unit : RAS-3M26S3AV-E,-A,-TR**  
**<Heating / 220V>**

Power supply (V)	Operating status	Indoor unit			Unit capacity (kW)			Total			Outdoor noise (dB)		
		A	B	C	A	B	C	Heating capacity (kW)	Power consumption (W)	Operating current (A)	Sound Pressure	Sound Power	
220	1 unit	07	-	-	2.70	-	-	2.7 ( 0.8 - 4.8 )	900 ( 300 - 1980 )	4.70 ( 1.87 - 9.18 )	49	64	
		10	-	-	4.00	-	-	4.0 ( 0.8 - 5.2 )	1450 ( 300 - 1980 )	6.94 ( 1.87 - 9.18 )	49	64	
		13	-	-	5.00	-	-	5.0 ( 0.8 - 6.5 )	2050 ( 310 - 2750 )	9.81 ( 1.93 - 12.76 )	49	64	
		16	-	-	5.50	-	-	5.5 ( 0.8 - 6.9 )	2400 ( 310 - 3000 )	11.48 ( 1.93 - 13.91 )	49	64	
		18	-	-	6.00	-	-	6.0 ( 0.8 - 7.1 )	2630 ( 310 - 3200 )	12.58 ( 1.93 - 14.84 )	49	64	
		22	-	-	7.00	-	-	7.0 ( 1.8 - 8.2 )	2620 ( 330 - 3200 )	12.41 ( 2.05 - 14.84 )	49	64	
		24	-	-	8.10	-	-	8.1 ( 1.8 - 8.6 )	3080 ( 330 - 3300 )	14.58 ( 2.05 - 15.31 )	49	64	
	2 units	07	07	-	-	2.70	2.70	-	5.4 ( 1.5 - 7.4 )	1500 ( 320 - 3200 )	7.18 ( 1.94 - 14.84 )	49	64
		10	07	-	-	4.00	2.70	-	6.7 ( 1.5 - 8.9 )	2080 ( 320 - 3200 )	9.95 ( 1.94 - 14.84 )	49	64
		13	07	-	-	4.81	2.59	-	7.4 ( 1.5 - 9.5 )	2300 ( 320 - 3200 )	11.00 ( 1.94 - 14.84 )	49	64
		16	07	-	-	5.10	2.50	-	7.6 ( 1.5 - 9.5 )	2300 ( 320 - 3200 )	11.00 ( 1.94 - 14.84 )	49	64
		18	07	-	-	5.45	2.45	-	7.9 ( 1.5 - 9.5 )	2450 ( 320 - 3200 )	11.72 ( 1.94 - 14.84 )	49	64
		22	07	-	-	5.70	2.20	-	7.9 ( 1.5 - 9.8 )	2450 ( 320 - 3200 )	11.72 ( 1.94 - 14.84 )	49	64
		24	07	-	-	6.23	2.08	-	8.3 ( 1.5 - 10.1 )	2500 ( 320 - 3250 )	11.96 ( 1.94 - 15.07 )	49	64
		10	10	-	-	3.60	3.60	-	7.2 ( 1.5 - 9.5 )	2200 ( 320 - 3200 )	10.53 ( 1.94 - 14.84 )	49	64
		13	10	-	-	4.22	3.38	-	7.6 ( 1.5 - 9.5 )	2300 ( 320 - 3200 )	11.00 ( 1.94 - 14.84 )	49	64
		16	10	-	-	4.57	3.33	-	7.9 ( 1.5 - 9.5 )	2450 ( 320 - 3200 )	11.72 ( 1.94 - 14.84 )	49	64
		18	10	-	-	4.74	3.16	-	7.9 ( 1.5 - 9.8 )	2450 ( 320 - 3200 )	11.72 ( 1.94 - 14.84 )	49	64
		22	10	-	-	5.28	3.02	-	8.3 ( 1.5 - 10.1 )	2500 ( 320 - 3250 )	11.96 ( 1.94 - 15.07 )	49	64
		24	10	-	-	5.76	2.84	-	8.6 ( 1.5 - 10.4 )	2550 ( 320 - 3250 )	12.20 ( 1.94 - 15.07 )	49	64
		13	13	-	-	3.95	3.95	-	7.9 ( 1.5 - 9.8 )	2450 ( 320 - 3200 )	11.72 ( 1.94 - 14.84 )	49	64
		16	13	-	-	4.35	3.95	-	8.3 ( 1.5 - 10.1 )	2500 ( 320 - 3250 )	11.96 ( 1.94 - 15.07 )	49	64
		18	13	-	-	4.53	3.77	-	8.3 ( 1.5 - 10.1 )	2500 ( 320 - 3250 )	11.96 ( 1.94 - 15.07 )	49	64
		22	13	-	-	5.02	3.58	-	8.6 ( 1.5 - 10.4 )	2550 ( 320 - 3250 )	12.20 ( 1.94 - 15.07 )	49	64
		24	13	-	-	5.32	3.28	-	8.6 ( 1.5 - 10.8 )	2550 ( 320 - 3250 )	12.20 ( 1.94 - 15.07 )	49	64
		16	16	-	-	4.30	4.30	-	8.6 ( 1.5 - 10.4 )	2550 ( 320 - 3250 )	12.20 ( 1.94 - 15.07 )	49	64
		18	16	-	-	4.49	4.11	-	8.6 ( 1.5 - 10.4 )	2550 ( 320 - 3250 )	12.20 ( 1.94 - 15.07 )	49	64
		22	16	-	-	4.82	3.78	-	8.6 ( 1.5 - 10.8 )	2550 ( 320 - 3250 )	12.20 ( 1.94 - 15.07 )	49	64
24	16	-	-	5.12	3.48	-	8.6 ( 1.5 - 10.8 )	2550 ( 320 - 3250 )	12.20 ( 1.94 - 15.07 )	49	64		
18	18	-	-	4.30	4.30	-	8.6 ( 1.5 - 10.8 )	2550 ( 320 - 3250 )	12.20 ( 1.94 - 15.07 )	49	64		
22	18	-	-	4.63	3.97	-	8.6 ( 1.5 - 10.8 )	2550 ( 320 - 3250 )	12.20 ( 1.94 - 15.07 )	49	64		
24	18	-	-	4.94	3.66	-	8.6 ( 1.5 - 10.8 )	2550 ( 320 - 3250 )	12.20 ( 1.94 - 15.07 )	49	64		

• The above specification values are those under the conditions that the indoor DB/WB=27/19°C and the outdoor DB/WB=35/-°C

## &lt;Heating / 220V&gt; (Continued)

Power supply (V)	Operating status	Indoor unit			Unit capacity (kW)			Total			Outdoor noise (dB)	
								Heating capacity (kW)	Power consumption (W)	Operating current (A)	Sound Pressure	Sound Power
		A	B	C	A	B	C					
220	3 units	07	07	07	2.70	2.70	2.70	8.1 ( 2.0 - 10.8 )	1800 ( 380 - 2750 )	8.61 ( 2.16 - 12.76 )	49	64
		10	07	07	3.53	2.38	2.38	8.3 ( 2.0 - 10.8 )	1900 ( 380 - 2750 )	9.09 ( 2.16 - 12.76 )	49	64
		13	07	07	4.28	2.31	2.31	8.9 ( 2.0 - 10.8 )	2175 ( 380 - 2750 )	10.41 ( 2.16 - 12.76 )	49	64
		16	07	07	4.49	2.20	2.20	8.9 ( 2.0 - 10.8 )	2175 ( 380 - 2750 )	10.41 ( 2.16 - 12.76 )	49	64
		18	07	07	4.68	2.11	2.11	8.9 ( 2.0 - 11.0 )	2175 ( 380 - 2830 )	10.41 ( 2.16 - 13.13 )	49	64
		22	07	07	5.02	1.94	1.94	8.9 ( 2.0 - 11.0 )	2175 ( 380 - 2830 )	10.41 ( 2.16 - 13.13 )	49	64
		24	07	07	5.34	1.78	1.78	8.9 ( 2.0 - 11.0 )	2175 ( 380 - 2830 )	10.41 ( 2.16 - 13.13 )	49	64
		10	10	07	3.18	3.18	2.14	8.5 ( 2.0 - 10.8 )	2000 ( 380 - 2750 )	9.57 ( 2.16 - 12.76 )	49	64
		13	10	07	3.80	3.04	2.05	8.9 ( 2.0 - 10.8 )	2175 ( 380 - 2750 )	10.41 ( 2.16 - 12.76 )	49	64
		16	10	07	4.01	2.92	1.97	8.9 ( 2.0 - 11.0 )	2175 ( 380 - 2830 )	10.41 ( 2.16 - 13.13 )	49	64
		18	10	07	4.20	2.80	1.89	8.9 ( 2.0 - 11.0 )	2175 ( 380 - 2830 )	10.41 ( 2.16 - 13.13 )	49	64
		22	10	07	4.55	2.60	1.75	8.9 ( 2.0 - 11.0 )	2175 ( 380 - 2830 )	10.41 ( 2.16 - 13.13 )	49	64
		24	10	07	4.87	2.41	1.62	8.9 ( 2.0 - 11.0 )	2175 ( 380 - 2830 )	10.41 ( 2.16 - 13.13 )	49	64
		13	13	07	3.50	3.50	1.89	8.9 ( 2.0 - 11.0 )	2175 ( 380 - 2830 )	10.41 ( 2.16 - 13.13 )	49	64
		16	13	07	3.71	3.37	1.82	8.9 ( 2.0 - 11.0 )	2175 ( 380 - 2830 )	10.41 ( 2.16 - 13.13 )	49	64
		18	13	07	3.90	3.25	1.75	8.9 ( 2.0 - 11.0 )	2175 ( 380 - 2830 )	10.41 ( 2.16 - 13.13 )	49	64
		22	13	07	4.24	3.03	1.63	8.9 ( 2.0 - 11.0 )	2175 ( 380 - 2830 )	10.41 ( 2.16 - 13.13 )	49	64
		24	13	07	4.56	2.82	1.52	8.9 ( 2.0 - 11.0 )	2175 ( 380 - 2830 )	10.41 ( 2.16 - 13.13 )	49	64
		16	16	07	3.57	3.57	1.75	8.9 ( 2.0 - 11.0 )	2175 ( 380 - 2830 )	10.41 ( 2.16 - 13.13 )	49	64
		18	16	07	3.76	3.45	1.69	8.9 ( 2.0 - 11.0 )	2175 ( 380 - 2830 )	10.41 ( 2.16 - 13.13 )	49	64
		22	16	07	4.14	3.26	1.60	9.0 ( 2.0 - 11.2 )	2200 ( 380 - 2900 )	10.53 ( 2.16 - 13.45 )	49	64
		24	16	07	4.47	3.04	1.49	9.0 ( 2.0 - 11.2 )	2200 ( 380 - 2900 )	10.53 ( 2.16 - 13.45 )	49	64
		10	10	10	2.97	2.97	2.97	8.9 ( 2.0 - 10.8 )	2175 ( 380 - 2750 )	10.41 ( 2.16 - 12.76 )	49	64
		13	10	10	3.42	2.74	2.74	8.9 ( 2.0 - 11.0 )	2175 ( 380 - 2830 )	10.41 ( 2.16 - 13.13 )	49	64
		16	10	10	3.63	2.64	2.64	8.9 ( 2.0 - 11.0 )	2175 ( 380 - 2830 )	10.41 ( 2.16 - 13.13 )	49	64
		18	10	10	3.81	2.54	2.54	8.9 ( 2.0 - 11.0 )	2175 ( 380 - 2830 )	10.41 ( 2.16 - 13.13 )	49	64
		22	10	10	4.15	2.37	2.37	8.9 ( 2.0 - 11.0 )	2175 ( 380 - 2830 )	10.41 ( 2.16 - 13.13 )	49	64
		24	10	10	4.48	2.21	2.21	8.9 ( 2.0 - 11.0 )	2175 ( 380 - 2830 )	10.41 ( 2.16 - 13.13 )	49	64
		13	13	10	3.18	3.18	2.54	8.9 ( 2.0 - 11.0 )	2175 ( 380 - 2830 )	10.41 ( 2.16 - 13.13 )	49	64
		16	13	10	3.38	3.07	2.46	8.9 ( 2.0 - 11.0 )	2175 ( 380 - 2830 )	10.41 ( 2.16 - 13.13 )	49	64
		18	13	10	3.56	2.97	2.37	8.9 ( 2.0 - 11.0 )	2175 ( 380 - 2830 )	10.41 ( 2.16 - 13.13 )	49	64
		22	13	10	3.94	2.81	2.25	9.0 ( 2.0 - 11.2 )	2200 ( 380 - 2900 )	10.53 ( 2.16 - 13.45 )	49	64
		24	13	10	4.26	2.63	2.11	9.0 ( 2.0 - 11.2 )	2200 ( 380 - 2900 )	10.53 ( 2.16 - 13.45 )	49	64
		16	16	10	3.26	3.26	2.37	8.9 ( 2.0 - 11.0 )	2175 ( 380 - 2830 )	10.41 ( 2.16 - 13.13 )	49	64
		18	16	10	3.45	3.16	2.30	8.9 ( 2.0 - 11.0 )	2175 ( 380 - 2830 )	10.41 ( 2.16 - 13.13 )	49	64
		22	16	10	3.82	3.00	2.18	9.0 ( 2.0 - 11.2 )	2200 ( 380 - 2900 )	10.53 ( 2.16 - 13.45 )	49	64
24	16	10	4.14	2.81	2.05	9.0 ( 2.0 - 11.2 )	2200 ( 380 - 2900 )	10.53 ( 2.16 - 13.45 )	49	64		
13	13	13	2.97	2.97	2.97	8.9 ( 2.0 - 11.0 )	2175 ( 380 - 2830 )	10.41 ( 2.16 - 13.13 )	49	64		
16	13	13	3.16	2.87	2.87	8.9 ( 2.0 - 11.0 )	2175 ( 380 - 2830 )	10.41 ( 2.16 - 13.13 )	49	64		
18	13	13	3.34	2.78	2.78	8.9 ( 2.0 - 11.0 )	2175 ( 380 - 2830 )	10.41 ( 2.16 - 13.13 )	49	64		
22	13	13	3.71	2.65	2.65	9.0 ( 2.0 - 11.2 )	2200 ( 380 - 2900 )	10.53 ( 2.16 - 13.45 )	49	64		
24	13	13	4.03	2.49	2.49	9.0 ( 2.0 - 11.2 )	2200 ( 380 - 2900 )	10.53 ( 2.16 - 13.45 )	49	64		
16	16	13	3.09	3.09	2.81	9.0 ( 2.0 - 11.2 )	2200 ( 380 - 2900 )	10.53 ( 2.16 - 13.45 )	49	64		
18	16	13	3.27	3.00	2.73	9.0 ( 2.0 - 11.2 )	2200 ( 380 - 2900 )	10.53 ( 2.16 - 13.45 )	49	64		
22	16	13	3.60	2.83	2.57	9.0 ( 2.0 - 11.2 )	2200 ( 380 - 2900 )	10.53 ( 2.16 - 13.45 )	49	64		
24	16	13	3.92	2.66	2.42	9.0 ( 2.0 - 11.2 )	2200 ( 380 - 2900 )	10.53 ( 2.16 - 13.45 )	49	64		
16	16	16	3.00	3.00	3.00	9.0 ( 2.0 - 11.2 )	2200 ( 380 - 2900 )	10.53 ( 2.16 - 13.45 )	49	64		
18	16	16	3.18	2.91	2.91	9.0 ( 2.0 - 11.2 )	2200 ( 380 - 2900 )	10.53 ( 2.16 - 13.45 )	49	64		
22	16	16	3.50	2.75	2.75	9.0 ( 2.0 - 11.2 )	2200 ( 380 - 2900 )	10.53 ( 2.16 - 13.45 )	49	64		

• The above specification values are those under the conditions that the indoor DB/WB=27/19°C and the outdoor DB/WB=35/-°C



## &lt;Heating / 230V&gt;

Power supply (V)	Operating status	Indoor unit			Unit capacity (kW)			Total			Outdoor noise (dB)	
								Heating capacity (kW)	Power consumption (W)	Operating current (A)	Sound Pressure	Sound Power
		A	B	C	A	B	C					
230	1 unit	07	-	-	2.70	-	-	2.7 ( 0.8 - 4.8 )	900 ( 300 - 1980 )	4.50 ( 1.79 - 8.78 )	49	64
		10	-	-	4.00	-	-	4.0 ( 0.8 - 5.2 )	1450 ( 300 - 1980 )	6.64 ( 1.79 - 8.78 )	49	64
		13	-	-	5.00	-	-	5.0 ( 0.8 - 6.5 )	2050 ( 310 - 2750 )	9.38 ( 1.85 - 12.20 )	49	64
		16	-	-	5.50	-	-	5.5 ( 0.8 - 6.9 )	2400 ( 310 - 3000 )	10.98 ( 1.85 - 13.31 )	49	64
		18	-	-	6.00	-	-	6.0 ( 0.8 - 7.1 )	2630 ( 310 - 3200 )	12.04 ( 1.85 - 14.20 )	49	64
		22	-	-	7.00	-	-	7.0 ( 1.8 - 8.2 )	2620 ( 330 - 3200 )	11.87 ( 1.97 - 14.20 )	49	64
		24	-	-	8.10	-	-	8.1 ( 1.8 - 8.6 )	3080 ( 330 - 3300 )	13.95 ( 1.97 - 14.64 )	49	64
		2 units	07	07	-	2.70	2.70	-	5.4 ( 1.5 - 7.4 )	1500 ( 320 - 3200 )	6.86 ( 1.86 - 14.20 )	49
	10		07	-	4.00	2.70	-	6.7 ( 1.5 - 8.9 )	2080 ( 320 - 3200 )	9.52 ( 1.86 - 14.20 )	49	64
	13		07	-	4.81	2.59	-	7.4 ( 1.5 - 9.5 )	2300 ( 320 - 3200 )	10.53 ( 1.86 - 14.20 )	49	64
	16		07	-	5.10	2.50	-	7.6 ( 1.5 - 9.5 )	2300 ( 320 - 3200 )	10.53 ( 1.86 - 14.20 )	49	64
	18		07	-	5.45	2.45	-	7.9 ( 1.5 - 9.5 )	2450 ( 320 - 3200 )	11.21 ( 1.86 - 14.20 )	49	64
	22		07	-	5.70	2.20	-	7.9 ( 1.5 - 9.8 )	2450 ( 320 - 3200 )	11.21 ( 1.86 - 14.20 )	49	64
	24		07	-	6.23	2.08	-	8.3 ( 1.5 - 10.1 )	2500 ( 320 - 3250 )	11.44 ( 1.86 - 14.42 )	49	64
	10		10	-	3.60	3.60	-	7.2 ( 1.5 - 9.5 )	2200 ( 320 - 3200 )	10.07 ( 1.86 - 14.20 )	49	64
	13		10	-	4.22	3.38	-	7.6 ( 1.5 - 9.5 )	2300 ( 320 - 3200 )	10.53 ( 1.86 - 14.20 )	49	64
	16		10	-	4.57	3.33	-	7.9 ( 1.5 - 9.5 )	2450 ( 320 - 3200 )	11.21 ( 1.86 - 14.20 )	49	64
	18		10	-	4.74	3.16	-	7.9 ( 1.5 - 9.8 )	2450 ( 320 - 3200 )	11.21 ( 1.86 - 14.20 )	49	64
	22		10	-	5.28	3.02	-	8.3 ( 1.5 - 10.1 )	2500 ( 320 - 3250 )	11.44 ( 1.86 - 14.42 )	49	64
	24		10	-	5.76	2.84	-	8.6 ( 1.5 - 10.4 )	2550 ( 320 - 3250 )	11.67 ( 1.86 - 14.42 )	49	64
	13		13	-	3.95	3.95	-	7.9 ( 1.5 - 9.8 )	2450 ( 320 - 3200 )	11.21 ( 1.86 - 14.20 )	49	64
	16		13	-	4.35	3.95	-	8.3 ( 1.5 - 10.1 )	2500 ( 320 - 3250 )	11.44 ( 1.86 - 14.42 )	49	64
	18		13	-	4.53	3.77	-	8.3 ( 1.5 - 10.1 )	2500 ( 320 - 3250 )	11.44 ( 1.86 - 14.42 )	49	64
	22		13	-	5.02	3.58	-	8.6 ( 1.5 - 10.4 )	2550 ( 320 - 3250 )	11.67 ( 1.86 - 14.42 )	49	64
	24		13	-	5.32	3.28	-	8.6 ( 1.5 - 10.8 )	2550 ( 320 - 3250 )	11.67 ( 1.86 - 14.42 )	49	64
	16		16	-	4.30	4.30	-	8.6 ( 1.5 - 10.4 )	2550 ( 320 - 3250 )	11.67 ( 1.86 - 14.42 )	49	64
	18		16	-	4.49	4.11	-	8.6 ( 1.5 - 10.4 )	2550 ( 320 - 3250 )	11.67 ( 1.86 - 14.42 )	49	64
	22		16	-	4.82	3.78	-	8.6 ( 1.5 - 10.8 )	2550 ( 320 - 3250 )	11.67 ( 1.86 - 14.42 )	49	64
	24		16	-	5.12	3.48	-	8.6 ( 1.5 - 10.8 )	2550 ( 320 - 3250 )	11.67 ( 1.86 - 14.42 )	49	64
	18	18	-	4.30	4.30	-	8.6 ( 1.5 - 10.8 )	2550 ( 320 - 3250 )	11.67 ( 1.86 - 14.42 )	49	64	
22	18	-	4.63	3.97	-	8.6 ( 1.5 - 10.8 )	2550 ( 320 - 3250 )	11.67 ( 1.86 - 14.42 )	49	64		
24	18	-	4.94	3.66	-	8.6 ( 1.5 - 10.8 )	2550 ( 320 - 3250 )	11.67 ( 1.86 - 14.42 )	49	64		

• The above specification values are those under the conditions that the indoor DB/WB=27/19°C and the outdoor DB/WB=35/-°C



<Heating / 230V> (Continued)

Power supply (V)	Operating status	Indoor unit			Unit capacity (kW)			Total			Outdoor noise (dB)	
		A	B	C	A	B	C	Heating capacity (kW)	Power consumption (W)	Operating current (A)	Sound Pressure	Sound Power
230	3 units	07	07	07	2.70	2.70	2.70	8.1 ( 2.0 - 10.8 )	1800 ( 380 - 2750 )	8.24 ( 2.07 - 12.20 )	49	64
		10	07	07	3.53	2.38	2.38	8.3 ( 2.0 - 10.8 )	1900 ( 380 - 2750 )	8.70 ( 2.07 - 12.20 )	49	64
		13	07	07	4.28	2.31	2.31	8.9 ( 2.0 - 10.8 )	2175 ( 380 - 2750 )	9.95 ( 2.07 - 12.20 )	49	64
		16	07	07	4.49	2.20	2.20	8.9 ( 2.0 - 10.8 )	2175 ( 380 - 2750 )	9.95 ( 2.07 - 12.20 )	49	64
		18	07	07	4.68	2.11	2.11	8.9 ( 2.0 - 11.0 )	2175 ( 380 - 2830 )	9.95 ( 2.07 - 12.56 )	49	64
		22	07	07	5.02	1.94	1.94	8.9 ( 2.0 - 11.0 )	2175 ( 380 - 2830 )	9.95 ( 2.07 - 12.56 )	49	64
		24	07	07	5.34	1.78	1.78	8.9 ( 2.0 - 11.0 )	2175 ( 380 - 2830 )	9.95 ( 2.07 - 12.56 )	49	64
		10	10	07	3.18	3.18	2.14	8.5 ( 2.0 - 10.8 )	2000 ( 380 - 2750 )	9.15 ( 2.07 - 12.20 )	49	64
		13	10	07	3.80	3.04	2.05	8.9 ( 2.0 - 10.8 )	2175 ( 380 - 2750 )	9.95 ( 2.07 - 12.20 )	49	64
		16	10	07	4.01	2.92	1.97	8.9 ( 2.0 - 11.0 )	2175 ( 380 - 2830 )	9.95 ( 2.07 - 12.56 )	49	64
		18	10	07	4.20	2.80	1.89	8.9 ( 2.0 - 11.0 )	2175 ( 380 - 2830 )	9.95 ( 2.07 - 12.56 )	49	64
		22	10	07	4.55	2.60	1.75	8.9 ( 2.0 - 11.0 )	2175 ( 380 - 2830 )	9.95 ( 2.07 - 12.56 )	49	64
		24	10	07	4.87	2.41	1.62	8.9 ( 2.0 - 11.0 )	2175 ( 380 - 2830 )	9.95 ( 2.07 - 12.56 )	49	64
		13	13	07	3.50	3.50	1.89	8.9 ( 2.0 - 11.0 )	2175 ( 380 - 2830 )	9.95 ( 2.07 - 12.56 )	49	64
		16	13	07	3.71	3.37	1.82	8.9 ( 2.0 - 11.0 )	2175 ( 380 - 2830 )	9.95 ( 2.07 - 12.56 )	49	64
		18	13	07	3.90	3.25	1.75	8.9 ( 2.0 - 11.0 )	2175 ( 380 - 2830 )	9.95 ( 2.07 - 12.56 )	49	64
		22	13	07	4.24	3.03	1.63	8.9 ( 2.0 - 11.0 )	2175 ( 380 - 2830 )	9.95 ( 2.07 - 12.56 )	49	64
		24	13	07	4.56	2.82	1.52	8.9 ( 2.0 - 11.0 )	2175 ( 380 - 2830 )	9.95 ( 2.07 - 12.56 )	49	64
		16	16	07	3.57	3.57	1.75	8.9 ( 2.0 - 11.0 )	2175 ( 380 - 2830 )	9.95 ( 2.07 - 12.56 )	49	64
		18	16	07	3.76	3.45	1.69	8.9 ( 2.0 - 11.0 )	2175 ( 380 - 2830 )	9.95 ( 2.07 - 12.56 )	49	64
		22	16	07	4.14	3.26	1.60	9.0 ( 2.0 - 11.2 )	2200 ( 380 - 2900 )	10.07 ( 2.07 - 12.87 )	49	64
		24	16	07	4.47	3.04	1.49	9.0 ( 2.0 - 11.2 )	2200 ( 380 - 2900 )	10.07 ( 2.07 - 12.87 )	49	64
		10	10	10	2.97	2.97	2.97	8.9 ( 2.0 - 10.8 )	2175 ( 380 - 2750 )	9.95 ( 2.07 - 12.20 )	49	64
		13	10	10	3.42	2.74	2.74	8.9 ( 2.0 - 11.0 )	2175 ( 380 - 2830 )	9.95 ( 2.07 - 12.56 )	49	64
		16	10	10	3.63	2.64	2.64	8.9 ( 2.0 - 11.0 )	2175 ( 380 - 2830 )	9.95 ( 2.07 - 12.56 )	49	64
		18	10	10	3.81	2.54	2.54	8.9 ( 2.0 - 11.0 )	2175 ( 380 - 2830 )	9.95 ( 2.07 - 12.56 )	49	64
		22	10	10	4.15	2.37	2.37	8.9 ( 2.0 - 11.0 )	2175 ( 380 - 2830 )	9.95 ( 2.07 - 12.56 )	49	64
		24	10	10	4.48	2.21	2.21	8.9 ( 2.0 - 11.0 )	2175 ( 380 - 2830 )	9.95 ( 2.07 - 12.56 )	49	64
		13	13	10	3.18	3.18	2.54	8.9 ( 2.0 - 11.0 )	2175 ( 380 - 2830 )	9.95 ( 2.07 - 12.56 )	49	64
		16	13	10	3.38	3.07	2.46	8.9 ( 2.0 - 11.0 )	2175 ( 380 - 2830 )	9.95 ( 2.07 - 12.56 )	49	64
		18	13	10	3.56	2.97	2.37	8.9 ( 2.0 - 11.0 )	2175 ( 380 - 2830 )	9.95 ( 2.07 - 12.56 )	49	64
		22	13	10	3.94	2.81	2.25	9.0 ( 2.0 - 11.2 )	2200 ( 380 - 2900 )	10.07 ( 2.07 - 12.87 )	49	64
		24	13	10	4.26	2.63	2.11	9.0 ( 2.0 - 11.2 )	2200 ( 380 - 2900 )	10.07 ( 2.07 - 12.87 )	49	64
		16	16	10	3.26	3.26	2.37	8.9 ( 2.0 - 11.0 )	2175 ( 380 - 2830 )	9.95 ( 2.07 - 12.56 )	49	64
		18	16	10	3.45	3.16	2.30	8.9 ( 2.0 - 11.0 )	2175 ( 380 - 2830 )	9.95 ( 2.07 - 12.56 )	49	64
		22	16	10	3.82	3.00	2.18	9.0 ( 2.0 - 11.2 )	2200 ( 380 - 2900 )	10.07 ( 2.07 - 12.87 )	49	64
		24	16	10	4.14	2.81	2.05	9.0 ( 2.0 - 11.2 )	2200 ( 380 - 2900 )	10.07 ( 2.07 - 12.87 )	49	64
		13	13	13	2.97	2.97	2.97	8.9 ( 2.0 - 11.0 )	2175 ( 380 - 2830 )	9.95 ( 2.07 - 12.56 )	49	64
		16	13	13	3.16	2.87	2.87	8.9 ( 2.0 - 11.0 )	2175 ( 380 - 2830 )	9.95 ( 2.07 - 12.56 )	49	64
		18	13	13	3.34	2.78	2.78	8.9 ( 2.0 - 11.0 )	2175 ( 380 - 2830 )	9.95 ( 2.07 - 12.56 )	49	64
		22	13	13	3.71	2.65	2.65	9.0 ( 2.0 - 11.2 )	2200 ( 380 - 2900 )	10.07 ( 2.07 - 12.87 )	49	64
		24	13	13	4.03	2.49	2.49	9.0 ( 2.0 - 11.2 )	2200 ( 380 - 2900 )	10.07 ( 2.07 - 12.87 )	49	64
16	16	13	3.09	3.09	2.81	9.0 ( 2.0 - 11.2 )	2200 ( 380 - 2900 )	10.07 ( 2.07 - 12.87 )	49	64		
18	16	13	3.27	3.00	2.73	9.0 ( 2.0 - 11.2 )	2200 ( 380 - 2900 )	10.07 ( 2.07 - 12.87 )	49	64		
22	16	13	3.60	2.83	2.57	9.0 ( 2.0 - 11.2 )	2200 ( 380 - 2900 )	10.07 ( 2.07 - 12.87 )	49	64		
24	16	13	3.92	2.66	2.42	9.0 ( 2.0 - 11.2 )	2200 ( 380 - 2900 )	10.07 ( 2.07 - 12.87 )	49	64		
16	16	16	3.00	3.00	3.00	9.0 ( 2.0 - 11.2 )	2200 ( 380 - 2900 )	10.07 ( 2.07 - 12.87 )	49	64		
18	16	16	3.18	2.91	2.91	9.0 ( 2.0 - 11.2 )	2200 ( 380 - 2900 )	10.07 ( 2.07 - 12.87 )	49	64		
22	16	16	3.50	2.75	2.75	9.0 ( 2.0 - 11.2 )	2200 ( 380 - 2900 )	10.07 ( 2.07 - 12.87 )	49	64		

• The above specification values are those under the conditions that the indoor DB/WB=27/19°C and the outdoor DB/WB=35/-°C

## &lt;Heating / 240V&gt;

Power supply (V)	Operating status	Indoor unit			Unit capacity (kW)			Total			Outdoor noise (dB)		
		A	B	C	A	B	C	Heating capacity (kW)	Power consumption (W)	Operating current (A)	Sound Pressure	Sound Power	
240	1 unit	07	-	-	2.70	-	-	2.7 ( 0.8 - 4.8 )	900 ( 300 - 1980 )	4.31 ( 1.71 - 8.42 )	49	64	
		10	-	-	4.00	-	-	4.0 ( 0.8 - 5.2 )	1450 ( 300 - 1980 )	6.36 ( 1.71 - 8.42 )	49	64	
		13	-	-	5.00	-	-	5.0 ( 0.8 - 6.5 )	2050 ( 310 - 2750 )	8.99 ( 1.77 - 11.69 )	49	64	
		16	-	-	5.50	-	-	5.5 ( 0.8 - 6.9 )	2400 ( 310 - 3000 )	10.53 ( 1.77 - 12.76 )	49	64	
		18	-	-	6.00	-	-	6.0 ( 0.8 - 7.1 )	2630 ( 310 - 3200 )	11.54 ( 1.77 - 13.61 )	49	64	
		22	-	-	7.00	-	-	7.0 ( 1.8 - 8.2 )	2620 ( 330 - 3200 )	11.37 ( 1.88 - 13.61 )	49	64	
		24	-	-	8.10	-	-	8.1 ( 1.8 - 8.6 )	3080 ( 330 - 3300 )	13.37 ( 1.88 - 14.03 )	49	64	
	2 units	07	07	-	-	2.70	2.70	-	5.4 ( 1.5 - 7.4 )	1500 ( 320 - 3200 )	6.58 ( 1.78 - 13.61 )	49	64
		10	07	-	-	4.00	2.70	-	6.7 ( 1.5 - 8.9 )	2080 ( 320 - 3200 )	9.12 ( 1.78 - 13.61 )	49	64
		13	07	-	-	4.81	2.59	-	7.4 ( 1.5 - 9.5 )	2300 ( 320 - 3200 )	10.09 ( 1.78 - 13.61 )	49	64
		16	07	-	-	5.10	2.50	-	7.6 ( 1.5 - 9.5 )	2300 ( 320 - 3200 )	10.09 ( 1.78 - 13.61 )	49	64
		18	07	-	-	5.45	2.45	-	7.9 ( 1.5 - 9.5 )	2450 ( 320 - 3200 )	10.75 ( 1.78 - 13.61 )	49	64
		22	07	-	-	5.70	2.20	-	7.9 ( 1.5 - 9.8 )	2450 ( 320 - 3200 )	10.75 ( 1.78 - 13.61 )	49	64
		24	07	-	-	6.23	2.08	-	8.3 ( 1.5 - 10.1 )	2500 ( 320 - 3250 )	10.96 ( 1.78 - 13.82 )	49	64
		10	10	-	-	3.60	3.60	-	7.2 ( 1.5 - 9.5 )	2200 ( 320 - 3200 )	9.65 ( 1.78 - 13.61 )	49	64
		13	10	-	-	4.22	3.38	-	7.6 ( 1.5 - 9.5 )	2300 ( 320 - 3200 )	10.09 ( 1.78 - 13.61 )	49	64
		16	10	-	-	4.57	3.33	-	7.9 ( 1.5 - 9.5 )	2450 ( 320 - 3200 )	10.75 ( 1.78 - 13.61 )	49	64
		18	10	-	-	4.74	3.16	-	7.9 ( 1.5 - 9.8 )	2450 ( 320 - 3200 )	10.75 ( 1.78 - 13.61 )	49	64
		22	10	-	-	5.28	3.02	-	8.3 ( 1.5 - 10.1 )	2500 ( 320 - 3250 )	10.96 ( 1.78 - 13.82 )	49	64
		24	10	-	-	5.76	2.84	-	8.6 ( 1.5 - 10.4 )	2550 ( 320 - 3250 )	11.18 ( 1.78 - 13.82 )	49	64
		13	13	-	-	3.95	3.95	-	7.9 ( 1.5 - 9.8 )	2450 ( 320 - 3200 )	10.75 ( 1.78 - 13.61 )	49	64
		16	13	-	-	4.35	3.95	-	8.3 ( 1.5 - 10.1 )	2500 ( 320 - 3250 )	10.96 ( 1.78 - 13.82 )	49	64
		18	13	-	-	4.53	3.77	-	8.3 ( 1.5 - 10.1 )	2500 ( 320 - 3250 )	10.96 ( 1.78 - 13.82 )	49	64
		22	13	-	-	5.02	3.58	-	8.6 ( 1.5 - 10.4 )	2550 ( 320 - 3250 )	11.18 ( 1.78 - 13.82 )	49	64
		24	13	-	-	5.32	3.28	-	8.6 ( 1.5 - 10.8 )	2550 ( 320 - 3250 )	11.18 ( 1.78 - 13.82 )	49	64
		16	16	-	-	4.30	4.30	-	8.6 ( 1.5 - 10.4 )	2550 ( 320 - 3250 )	11.18 ( 1.78 - 13.82 )	49	64
		18	16	-	-	4.49	4.11	-	8.6 ( 1.5 - 10.4 )	2550 ( 320 - 3250 )	11.18 ( 1.78 - 13.82 )	49	64
		22	16	-	-	4.82	3.78	-	8.6 ( 1.5 - 10.8 )	2550 ( 320 - 3250 )	11.18 ( 1.78 - 13.82 )	49	64
24	16	-	-	5.12	3.48	-	8.6 ( 1.5 - 10.8 )	2550 ( 320 - 3250 )	11.18 ( 1.78 - 13.82 )	49	64		
18	18	-	-	4.30	4.30	-	8.6 ( 1.5 - 10.8 )	2550 ( 320 - 3250 )	11.18 ( 1.78 - 13.82 )	49	64		
22	18	-	-	4.63	3.97	-	8.6 ( 1.5 - 10.8 )	2550 ( 320 - 3250 )	11.18 ( 1.78 - 13.82 )	49	64		
24	18	-	-	4.94	3.66	-	8.6 ( 1.5 - 10.8 )	2550 ( 320 - 3250 )	11.18 ( 1.78 - 13.82 )	49	64		

• The above specification values are those under the conditions that the indoor DB/WB=27/19°C and the outdoor DB/WB=35/-°C

## &lt;Heating / 240V&gt; (Continued)

Power supply (V)	Operating status	Indoor unit			Unit capacity (kW)			Total			Outdoor noise (dB)	
								Heating capacity (kW)	Power consumption (W)	Operating current (A)	Sound Pressure	Sound Power
		A	B	C	A	B	C					
240	3 units	07	07	07	2.70	2.70	2.70	8.1 ( 2.0 - 10.8 )	1800 ( 380 - 2750 )	7.89 ( 1.98 - 11.69 )	49	64
		10	07	07	3.53	2.38	2.38	8.3 ( 2.0 - 10.8 )	1900 ( 380 - 2750 )	8.33 ( 1.98 - 11.69 )	49	64
		13	07	07	4.28	2.31	2.31	8.9 ( 2.0 - 10.8 )	2175 ( 380 - 2750 )	9.54 ( 1.98 - 11.69 )	49	64
		16	07	07	4.49	2.20	2.20	8.9 ( 2.0 - 10.8 )	2175 ( 380 - 2750 )	9.54 ( 1.98 - 11.69 )	49	64
		18	07	07	4.68	2.11	2.11	8.9 ( 2.0 - 11.0 )	2175 ( 380 - 2830 )	9.54 ( 1.98 - 12.03 )	49	64
		22	07	07	5.02	1.94	1.94	8.9 ( 2.0 - 11.0 )	2175 ( 380 - 2830 )	9.54 ( 1.98 - 12.03 )	49	64
		24	07	07	5.34	1.78	1.78	8.9 ( 2.0 - 11.0 )	2175 ( 380 - 2830 )	9.54 ( 1.98 - 12.03 )	49	64
		10	10	07	3.18	3.18	2.14	8.5 ( 2.0 - 10.8 )	2000 ( 380 - 2750 )	8.77 ( 1.98 - 11.69 )	49	64
		13	10	07	3.80	3.04	2.05	8.9 ( 2.0 - 10.8 )	2175 ( 380 - 2750 )	9.54 ( 1.98 - 11.69 )	49	64
		16	10	07	4.01	2.92	1.97	8.9 ( 2.0 - 11.0 )	2175 ( 380 - 2830 )	9.54 ( 1.98 - 12.03 )	49	64
		18	10	07	4.20	2.80	1.89	8.9 ( 2.0 - 11.0 )	2175 ( 380 - 2830 )	9.54 ( 1.98 - 12.03 )	49	64
		22	10	07	4.55	2.60	1.75	8.9 ( 2.0 - 11.0 )	2175 ( 380 - 2830 )	9.54 ( 1.98 - 12.03 )	49	64
		24	10	07	4.87	2.41	1.62	8.9 ( 2.0 - 11.0 )	2175 ( 380 - 2830 )	9.54 ( 1.98 - 12.03 )	49	64
		13	13	07	3.50	3.50	1.89	8.9 ( 2.0 - 11.0 )	2175 ( 380 - 2830 )	9.54 ( 1.98 - 12.03 )	49	64
		16	13	07	3.71	3.37	1.82	8.9 ( 2.0 - 11.0 )	2175 ( 380 - 2830 )	9.54 ( 1.98 - 12.03 )	49	64
		18	13	07	3.90	3.25	1.75	8.9 ( 2.0 - 11.0 )	2175 ( 380 - 2830 )	9.54 ( 1.98 - 12.03 )	49	64
		22	13	07	4.24	3.03	1.63	8.9 ( 2.0 - 11.0 )	2175 ( 380 - 2830 )	9.54 ( 1.98 - 12.03 )	49	64
		24	13	07	4.56	2.82	1.52	8.9 ( 2.0 - 11.0 )	2175 ( 380 - 2830 )	9.54 ( 1.98 - 12.03 )	49	64
		16	16	07	3.57	3.57	1.75	8.9 ( 2.0 - 11.0 )	2175 ( 380 - 2830 )	9.54 ( 1.98 - 12.03 )	49	64
		18	16	07	3.76	3.45	1.69	8.9 ( 2.0 - 11.0 )	2175 ( 380 - 2830 )	9.54 ( 1.98 - 12.03 )	49	64
		22	16	07	4.14	3.26	1.60	9.0 ( 2.0 - 11.2 )	2200 ( 380 - 2900 )	9.65 ( 1.98 - 12.33 )	49	64
		24	16	07	4.47	3.04	1.49	9.0 ( 2.0 - 11.2 )	2200 ( 380 - 2900 )	9.65 ( 1.98 - 12.33 )	49	64
		10	10	10	2.97	2.97	2.97	8.9 ( 2.0 - 10.8 )	2175 ( 380 - 2750 )	9.54 ( 1.98 - 11.69 )	49	64
		13	10	10	3.42	2.74	2.74	8.9 ( 2.0 - 11.0 )	2175 ( 380 - 2830 )	9.54 ( 1.98 - 12.03 )	49	64
		16	10	10	3.63	2.64	2.64	8.9 ( 2.0 - 11.0 )	2175 ( 380 - 2830 )	9.54 ( 1.98 - 12.03 )	49	64
		18	10	10	3.81	2.54	2.54	8.9 ( 2.0 - 11.0 )	2175 ( 380 - 2830 )	9.54 ( 1.98 - 12.03 )	49	64
		22	10	10	4.15	2.37	2.37	8.9 ( 2.0 - 11.0 )	2175 ( 380 - 2830 )	9.54 ( 1.98 - 12.03 )	49	64
		24	10	10	4.48	2.21	2.21	8.9 ( 2.0 - 11.0 )	2175 ( 380 - 2830 )	9.54 ( 1.98 - 12.03 )	49	64
		13	13	10	3.18	3.18	2.54	8.9 ( 2.0 - 11.0 )	2175 ( 380 - 2830 )	9.54 ( 1.98 - 12.03 )	49	64
		16	13	10	3.38	3.07	2.46	8.9 ( 2.0 - 11.0 )	2175 ( 380 - 2830 )	9.54 ( 1.98 - 12.03 )	49	64
		18	13	10	3.56	2.97	2.37	8.9 ( 2.0 - 11.0 )	2175 ( 380 - 2830 )	9.54 ( 1.98 - 12.03 )	49	64
		22	13	10	3.94	2.81	2.25	9.0 ( 2.0 - 11.2 )	2200 ( 380 - 2900 )	9.65 ( 1.98 - 12.33 )	49	64
		24	13	10	4.26	2.63	2.11	9.0 ( 2.0 - 11.2 )	2200 ( 380 - 2900 )	9.65 ( 1.98 - 12.33 )	49	64
		16	16	10	3.26	3.26	2.37	8.9 ( 2.0 - 11.0 )	2175 ( 380 - 2830 )	9.54 ( 1.98 - 12.03 )	49	64
		18	16	10	3.45	3.16	2.30	8.9 ( 2.0 - 11.0 )	2175 ( 380 - 2830 )	9.54 ( 1.98 - 12.03 )	49	64
		22	16	10	3.82	3.00	2.18	9.0 ( 2.0 - 11.2 )	2200 ( 380 - 2900 )	9.65 ( 1.98 - 12.33 )	49	64
		24	16	10	4.14	2.81	2.05	9.0 ( 2.0 - 11.2 )	2200 ( 380 - 2900 )	9.65 ( 1.98 - 12.33 )	49	64
		13	13	13	2.97	2.97	2.97	8.9 ( 2.0 - 11.0 )	2175 ( 380 - 2830 )	9.54 ( 1.98 - 12.03 )	49	64
		16	13	13	3.16	2.87	2.87	8.9 ( 2.0 - 11.0 )	2175 ( 380 - 2830 )	9.54 ( 1.98 - 12.03 )	49	64
		18	13	13	3.34	2.78	2.78	8.9 ( 2.0 - 11.0 )	2175 ( 380 - 2830 )	9.54 ( 1.98 - 12.03 )	49	64
		22	13	13	3.71	2.65	2.65	9.0 ( 2.0 - 11.2 )	2200 ( 380 - 2900 )	9.65 ( 1.98 - 12.33 )	49	64
		24	13	13	4.03	2.49	2.49	9.0 ( 2.0 - 11.2 )	2200 ( 380 - 2900 )	9.65 ( 1.98 - 12.33 )	49	64
16	16	13	3.09	3.09	2.81	9.0 ( 2.0 - 11.2 )	2200 ( 380 - 2900 )	9.65 ( 1.98 - 12.33 )	49	64		
18	16	13	3.27	3.00	2.73	9.0 ( 2.0 - 11.2 )	2200 ( 380 - 2900 )	9.65 ( 1.98 - 12.33 )	49	64		
22	16	13	3.60	2.83	2.57	9.0 ( 2.0 - 11.2 )	2200 ( 380 - 2900 )	9.65 ( 1.98 - 12.33 )	49	64		
24	16	13	3.92	2.66	2.42	9.0 ( 2.0 - 11.2 )	2200 ( 380 - 2900 )	9.65 ( 1.98 - 12.33 )	49	64		
16	16	16	3.00	3.00	3.00	9.0 ( 2.0 - 11.2 )	2200 ( 380 - 2900 )	9.65 ( 1.98 - 12.33 )	49	64		
18	16	16	3.18	2.91	2.91	9.0 ( 2.0 - 11.2 )	2200 ( 380 - 2900 )	9.65 ( 1.98 - 12.33 )	49	64		
22	16	16	3.50	2.75	2.75	9.0 ( 2.0 - 11.2 )	2200 ( 380 - 2900 )	9.65 ( 1.98 - 12.33 )	49	64		

• The above specification values are those under the conditions that the indoor DB/WB=27/19°C and the outdoor DB/WB=35/-°C

### 2-3-1. Operation Characteristic Curve

<Cooling>

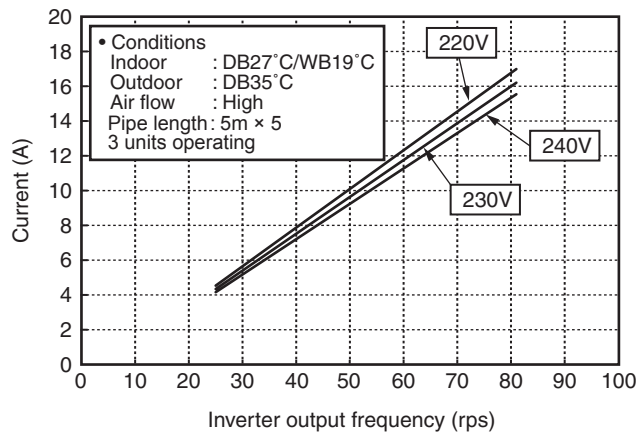

<Heating>

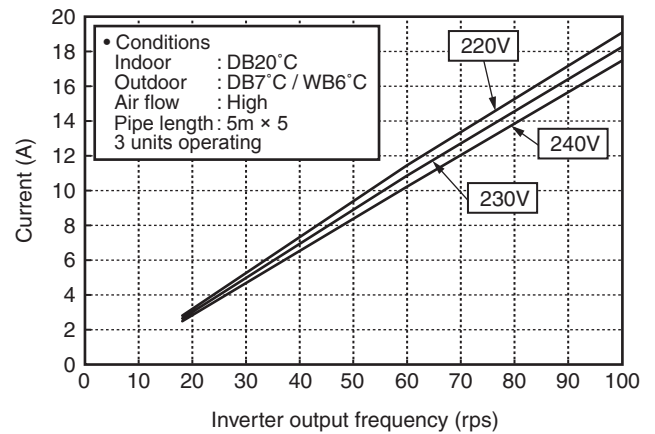

### 2-3-2. Capacity Variation Ratio According to Outdoor Temperature

<Cooling>

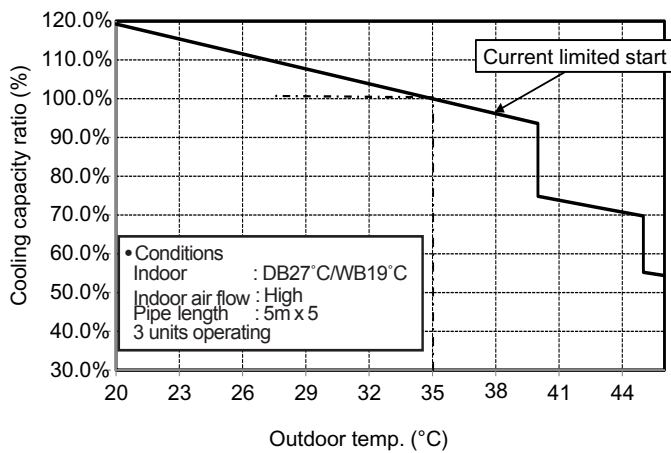

<Heating>

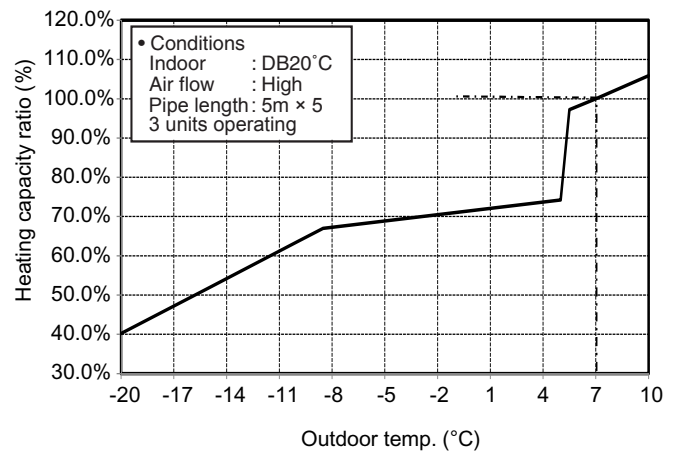

### 2-3-3. Capacity Variation Ratio According to Pipe Length

<Cooling>

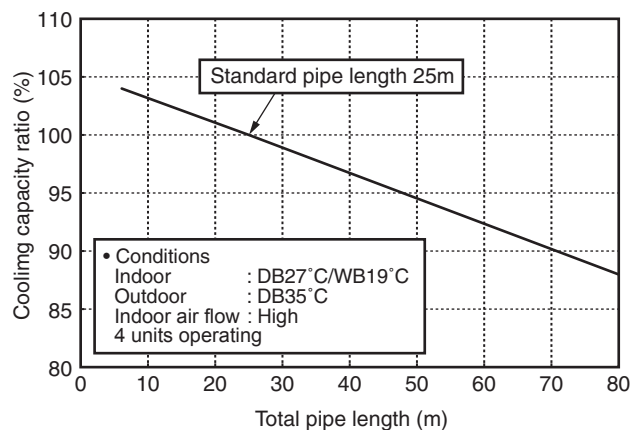

<Heating>

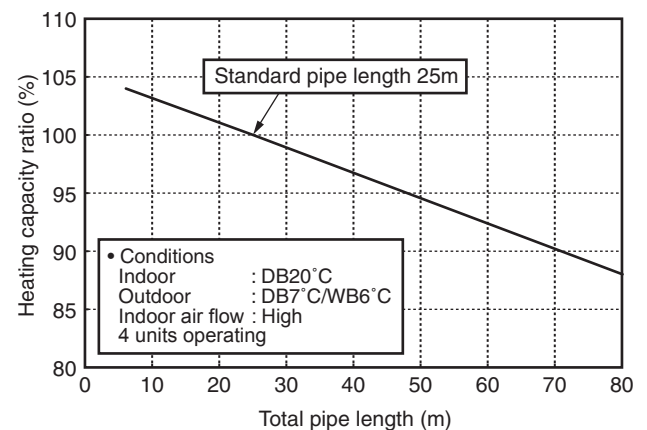

### 3. REFRIGERANT R410A

This air conditioner adopts the new refrigerant HFC (R410A) which does not damage the ozone layer. The working pressure of the new refrigerant R410A is 1.6 times higher than conventional refrigerant (R22). The refrigerating oil is also changed in accordance with change of refrigerant, so be careful that water, dust, and existing refrigerant or refrigerating oil are not entered in the refrigerant cycle of the air conditioner using the new refrigerant during installation work or servicing time.

The next section describes the precautions for air conditioner using the new refrigerant.

Conforming to contents of the next section together with the general cautions included in this manual, perform the correct and safe work.

#### 3-1. Safety During Installation/Serviceing

As R410A's pressure is about 1.6 times higher than that of R22, improper installation/servicing may cause a serious trouble. By using tools and materials exclusive for R410A, it is necessary to carry out installation/servicing safely while taking the following precautions into consideration.

1. Never use refrigerant other than R410A in an air conditioner which is designed to operate with R410A. If other refrigerant than R410A is mixed, pressure in the refrigeration cycle becomes abnormally high, and it may cause personal injury, etc. by a rupture.
2. Confirm the used refrigerant name, and use tools and materials exclusive for the refrigerant R410A. The refrigerant name R410A is indicated on the visible place of the outdoor unit of the air conditioner using R410A as refrigerant.  
To prevent mischarging, the diameter of the service port differs from that of R22.
3. If a refrigeration gas leakage occurs during installation/servicing, be sure to ventilate fully.  
If the refrigerant gas comes into contact with fire, a poisonous gas may occur.
4. When installing or removing an air conditioner, do not allow air or moisture to remain in the refrigeration cycle.  
Otherwise, pressure in the refrigeration cycle may become abnormally high so that a rupture or personal injury may be caused.
5. After completion of installation work, check to make sure that there is no refrigeration gas leakage. If the refrigerant gas leaks into the room, coming into contact with fire in the fan-driven heater, space heater, etc., a poisonous gas may occur.

6. When an air conditioning system charged with a large volume of refrigerant is installed in a small room, it is necessary to exercise care so that, even when refrigerant leaks, its concentration does not exceed the marginal level.

If the refrigerant gas leakage occurs and its concentration exceeds the marginal level, an oxygen starvation accident may result.

7. Be sure to carry out installation or removal according to the installation manual.  
Improper installation may cause refrigeration trouble, water leakage, electric shock, fire, etc.
8. Unauthorized modifications to the air conditioner may be dangerous.  
If a breakdown occurs please call a qualified air conditioner technician or electrician.  
Improper repair may result in water leakage, electric shock and fire, etc.

#### 3-2. Refrigerant Piping Installation

##### 3-2-1. Piping Materials and Joints Used

For the refrigerant piping installation, copper pipes and joints are mainly used. Copper pipes and joints suitable for the refrigerant must be chosen and installed. Furthermore, it is necessary to use clean copper pipes and joints whose interior surfaces are less affected by contaminants.

##### 1. Copper Pipes

It is necessary to use seamless copper pipes which are made of either copper or copper alloy and it is desirable that the amount of residual oil is less than 40 mg/10 m.

Do not use copper pipes having a collapsed, deformed or discolored portion (especially on the interior surface).

Otherwise, the expansion valve or capillary tube may become blocked with contaminants.

As an air conditioner using R410A incurs pressure higher than when using R22, it is necessary to choose adequate materials.

Thicknesses of copper pipes used with R410A are as shown in Table 3-2-1.

Never use copper pipes thinner than 0.8 mm even when it is available on the market.

**Table 3-2-1 Thicknesses of annealed copper pipes**

		Thickness (mm)	
Nominal diameter	Outer diameter (mm)	R410A	R22
1/4	6.35	0.80	0.80
3/8	9.52	0.80	0.80
1/2	12.70	0.80	0.80
5/8	15.88	1.00	1.00

## 2. Joints

For copper pipes, flare joints or socket joints are used. Prior to use, be sure to remove all contaminants.

### a) Flare Joints

Flare joints used to connect the copper pipes cannot be used for pipings whose outer diameter exceeds 20 mm. In such a case, socket joints can be used.

Sizes of flare pipe ends, flare joint ends and flare nuts are as shown in Tables 3-2-3 to 3-2-6 below.

### b) Socket Joints

Socket joints are such that they are brazed for connections, and used mainly for thick pipings whose diameter is larger than 20 mm.

Thicknesses of socket joints are as shown in Table 3-2-2.

**Table 3-2-2 Minimum thicknesses of socket joints**

Nominal diameter	Reference outer diameter of copper pipe jointed (mm)	Minimum joint thickness (mm)
1/4	6.35	0.50
3/8	9.52	0.60
1/2	12.70	0.70
5/8	15.88	0.80

## 3-2-2. Processing of Piping Materials

When performing the refrigerant piping installation, care should be taken to ensure that water or dust does not enter the pipe interior, that no other oil than lubricating oils used in the installed air-water heat pump is used, and that refrigerant does not leak.

When using lubricating oils in the piping processing, use such lubricating oils whose water content has been removed. When stored, be sure to seal the container with an airtight cap or any other cover.

### 1. Flare processing procedures and precautions

#### a) Cutting the Pipe

By means of a pipe cutter, slowly cut the pipe so that it is not deformed.

#### b) Removing Burrs and Chips

If the flared section has chips or burrs, refrigerant leakage may occur.

Carefully remove all burrs and clean the cut surface before installation.

#### c) Insertion of Flare Nut

d) Flare Processing

Make certain that a clamp bar and copper pipe have been cleaned.

By means of the clamp bar, perform the flare processing correctly.

Use either a flare tool for R410A or conventional flare tool.

Flare processing dimensions differ according to the type of flare tool.

When using a conventional flare tool, be sure to secure "dimension A" by using a gauge for size adjustment.

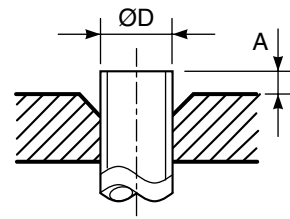

Fig. 3-2-1 Flare processing dimensions

Table 3-2-3 Dimensions related to flare processing for R410A

Nominal diameter	Outer diameter (mm)	Thickness (mm)	A (mm)		
			Flare tool for R410A clutch type	Conventional flare tool	
				Clutch type	Wing nut type
1/4	6.35	0.8	0 to 0.5	1.0 to 1.5	1.5 to 2.0
3/8	9.52	0.8	0 to 0.5	1.0 to 1.5	1.5 to 2.0
1/2	12.70	0.8	0 to 0.5	1.0 to 1.5	2.0 to 2.5
5/8	15.88	1.0	0 to 0.5	1.0 to 1.5	2.0 to 2.5

Table 3-2-4 Dimensions related to flare processing for R22

Nominal diameter	Outer diameter (mm)	Thickness (mm)	A (mm)		
			Flare tool for R22 clutch type	Conventional flare tool	
				Clutch type	Wing nut type
1/4	6.35	0.8	0 to 0.5	0.5 to 1.0	1.0 to 1.5
3/8	9.52	0.8	0 to 0.5	0.5 to 1.0	1.0 to 1.5
1/2	12.70	0.8	0 to 0.5	0.5 to 1.0	1.5 to 2.0
5/8	15.88	1.0	0 to 0.5	0.5 to 1.0	1.5 to 2.0

Table 3-2-5 Flare and flare nut dimensions for R410A

Nominal diameter	Outer diameter (mm)	Thickness (mm)	Dimension (mm)				Flare nut width (mm)
			A	B	C	D	
1/4	6.35	0.8	9.1	9.2	6.5	13	17
3/8	9.52	0.8	13.2	13.5	9.7	20	22
1/2	12.70	0.8	16.0	16.6	12.9	23	26
5/8	15.88	1.0	19.0	19.7	16.0	25	29



Table 3-2-6 Flare and flare nut dimensions for R22

Nominal diameter	Outer diameter (mm)	Thickness (mm)	Dimension (mm)				Flare nut width (mm)
			A	B	C	D	
1/4	6.35	0.8	9.0	9.2	6.5	13	17
3/8	9.52	0.8	13.0	13.5	9.7	20	22
1/2	12.70	0.8	16.0	16.2	12.9	20	24
5/8	15.88	1.0	19.0	19.7	16.0	23	27
3/4	19.05	1.0	23.3	24.0	19.2	34	36

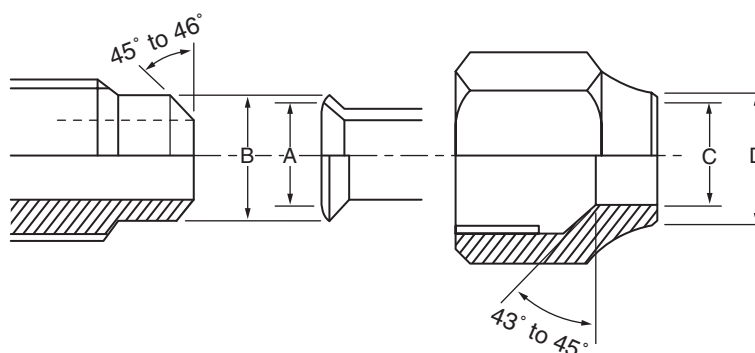

Fig. 3-2-2 Relations between flare nut and flare seal surface

## 2. Flare Connecting Procedures and Precautions

- Make sure that the flare and union portions do not have any scar or dust, etc.
- Correctly align the processed flare surface with the union axis.
- Tighten the flare with designated torque by means of a torque wrench.

The tightening torque for R410A is the same as that for conventional R22.

Incidentally, when the torque is weak, the gas leakage may occur.

When it is strong, the flare nut may crack and may be made non-removable. When choosing the tightening torque, comply with values designated by manufacturers. Table 3-2-7 shows reference values.

### NOTE :

When applying oil to the flare surface, be sure to use oil designated by the manufacturer.

If any other oil is used, the lubricating oils may deteriorate and cause the compressor to burn out.

Table 3-2-7 Tightening torque of flare for R410A [Reference values]

Nominal diameter	Outer diameter (mm)	Tightening torque N·m (kgf·cm)	Tightening torque of torque wrenches available on the market N·m (kgf·cm)
1/4	6.35	14 to 18 (140 to 180)	16 (160), 18 (180)
3/8	9.52	33 to 42 (330 to 420)	42 (420)
1/2	12.70	50 to 62 (500 to 620)	55 (550)
5/8	15.88	63 to 77 (630 to 770)	65 (650)



### 3-3. Tools

#### 3-3-1. Required Tools

The service port diameter of packed valve of the outdoor unit in the air-water heat pump using R410A is changed to prevent mixing of other refrigerant.

To reinforce the pressure-resisting strength, flare processing dimensions and opposite side dimension of flare nut (For Ø12.7 copper pipe) of the refrigerant piping are lengthened.

The used refrigerating oil is changed, and mixing of oil may cause a trouble such as generation of sludge, clogging of capillary, etc. Accordingly, the tools to be used are classified into the following three types.

1. Tools exclusive for R410A (Those which cannot be used for conventional refrigerant (R22))
2. Tools exclusive for R410A, but can be also used for conventional refrigerant (R22)
3. Tools commonly used for R410A and for conventional refrigerant (R22)

The table below shows the tools exclusive for R410A and their interchangeability.

#### Tools exclusive for R410A (The following tools for R410A are required.)

Tools whose specifications are changed for R410A and their interchangeability

No.	Used tool	Usage	R410A air-water heat pump installation		Conventional air-water heat pump installation
			Existence of new equipment for R410A	Whether conventional equipment can be used	Whether new equipment can be used with conventional refrigerant
1	Flare tool	Pipe flaring	Yes	* (Note 1)	Yes
2	Copper pipe gauge for adjusting projection margin	Flaring by conventional flare tool	Yes	* (Note 1)	* (Note 1)
3	Torque wrench (For Ø12.7)	Connection of flare nut	Yes	No	No
4	Gauge manifold	Evacuating, refrigerant charge, run check, etc.	Yes	No	No
5	Charge hose				
6	Vacuum pump adapter	Vacuum evacuating	Yes	No	Yes
7	Electronic balance for refrigerant charging	Refrigerant charge	Yes	No	Yes
8	Refrigerant cylinder	Refrigerant charge	Yes	No	No
9	Leakage detector	Gas leakage check	Yes	No	Yes
10	Charging cylinder	Refrigerant charge	(Note 2)	No	No

**(Note 1)** When flaring is carried out for R410A using the conventional flare tools, adjustment of projection margin is necessary. For this adjustment, a copper pipe gauge, etc. are necessary.

**(Note 2)** Charging cylinder for R410A is being currently developed.

#### General tools (Conventional tools can be used.)

In addition to the above exclusive tools, the following equipments which serve also for R22 are necessary as the general tools.

- |   |   |
|---|---|
| <ol style="list-style-type: none"> <li>1. Vacuum pump<br/>Use vacuum pump by attaching vacuum pump adapter.</li> <li>2. Torque wrench (For Ø6.35, Ø9.52)</li> <li>3. Pipe cutter</li> <li>4. Reamer</li> <li>5. Pipe bender</li> <li>6. Level vial</li> </ol> | <ol style="list-style-type: none"> <li>7. Screwdriver (+, -)</li> <li>8. Spanner or Monkey wrench</li> <li>9. Hole core drill (Ø65)</li> <li>10. Hexagon wrench (Opposite side 4mm)</li> <li>11. Tape measure</li> <li>12. Metal saw</li> </ol> |
|---|---|

Also prepare the following equipments for other installation method and run check.

- |  |   |
|--|---|
| <ol style="list-style-type: none"> <li>1. Clamp meter</li> <li>2. Thermometer</li> </ol> | <ol style="list-style-type: none"> <li>3. Insulation resistance tester</li> <li>4. Electro-scope</li> </ol> |
|--|---|

### 3-4. Recharging of Refrigerant

When it is necessary to recharge refrigerant, charge the specified amount of new refrigerant according to the following steps.

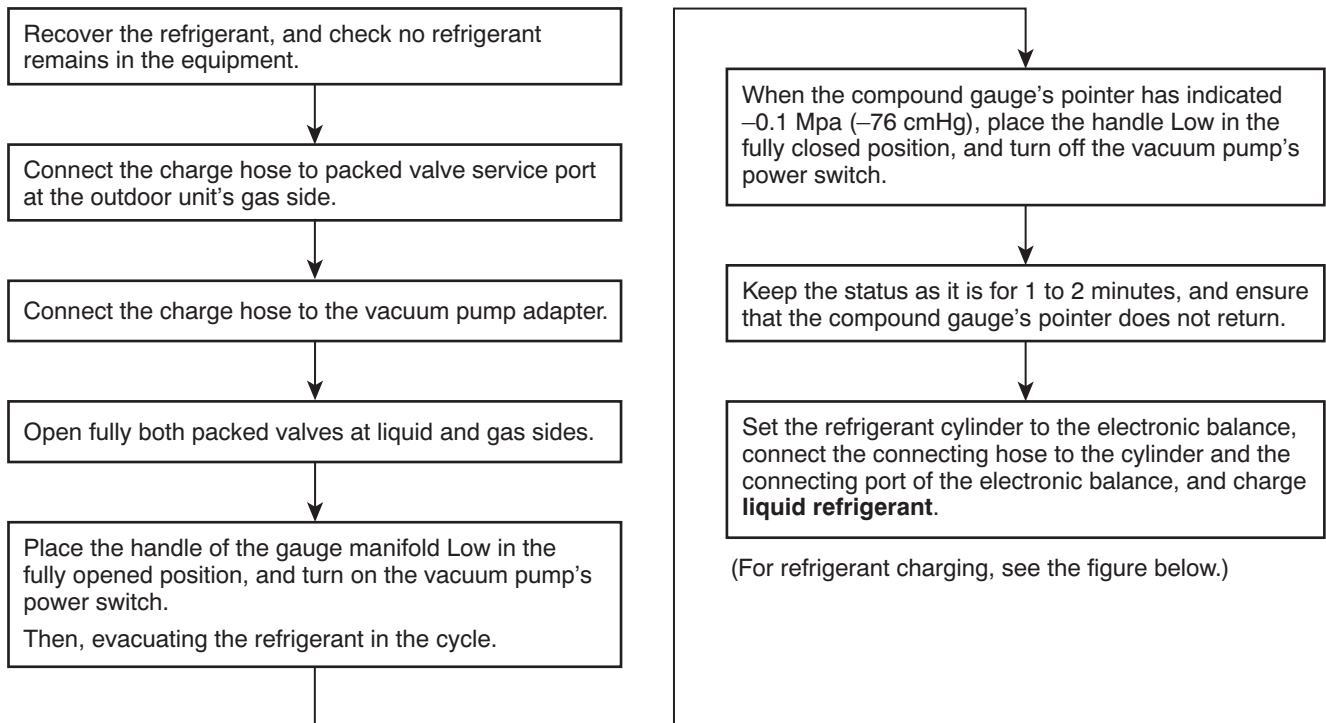

### ⚠ CAUTION

1. Never charge refrigerant exceeding the specified amount.
2. If the specified amount of refrigerant cannot be charged, charge refrigerant **bit by bit** in COOL mode.
3. Do not carry out additional charging.

When additional charging is carried out if refrigerant leaks, the refrigerant composition changes in the refrigeration cycle, that is characteristics of the air conditioner changes, refrigerant exceeding the specified amount is charged, and working pressure in the refrigeration cycle becomes abnormally high pressure, and may cause a rupture or personal injury.

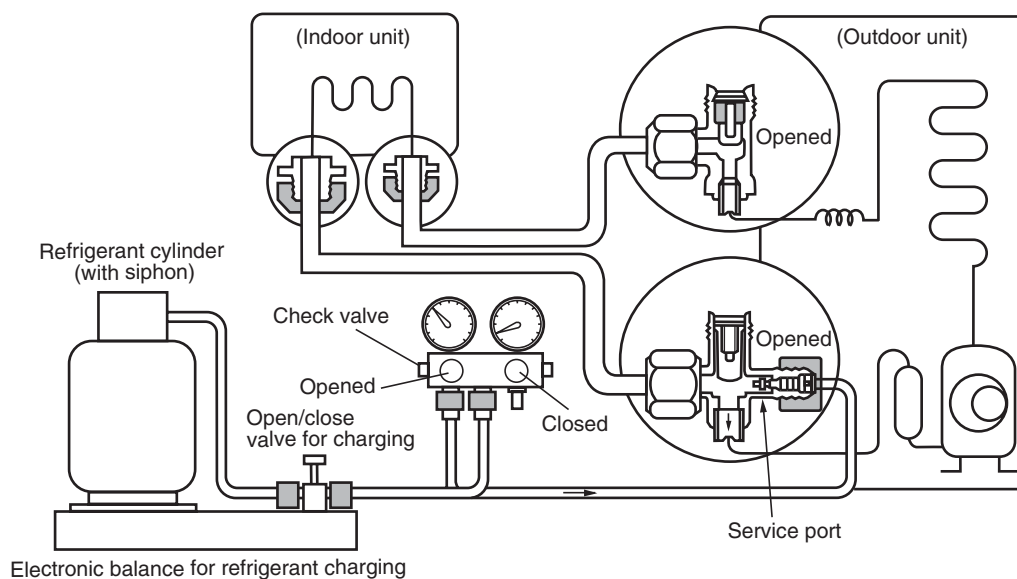
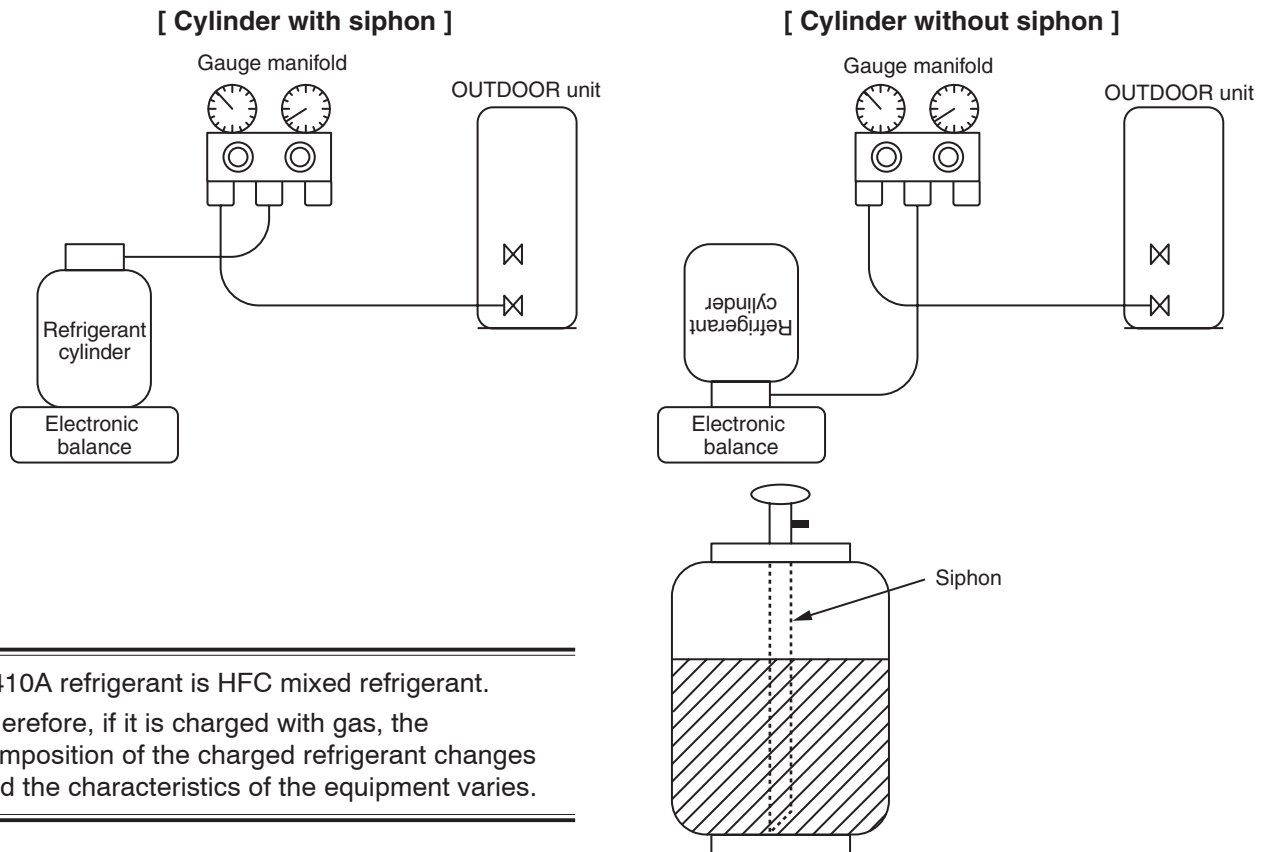

Fig. 3-4-1 Configuration of refrigerant charging

1. Be sure to make setting so that **liquid** can be charged.
2. When using a cylinder equipped with a siphon, liquid can be charged without turning it upside down.

It is necessary for charging refrigerant under condition of liquid because R410A is mixed type of refrigerant. Accordingly, when charging refrigerant from the refrigerant cylinder to the equipment, charge it turning the cylinder upside down if cylinder is not equipped with siphon.



R410A refrigerant is HFC mixed refrigerant. Therefore, if it is charged with gas, the composition of the charged refrigerant changes and the characteristics of the equipment varies.

Fig. 3-4-2

### 3-5. Brazing of Pipes

#### 3-5-1. Materials for Brazing

##### 1. Silver brazing filler

Silver brazing filler is an alloy mainly composed of silver and copper.

It is used to join iron, copper or copper alloy, and is relatively expensive though it excels in solderability.

##### 2. Phosphor bronze brazing filler

Phosphor bronze brazing filler is generally used to join copper or copper alloy.

##### 3. Low temperature brazing filler

Low temperature brazing filler is generally called solder, and is an alloy of tin and lead. Since it is weak in adhesive strength, do not use it for refrigerant pipes.

1. Phosphor bronze brazing filler tends to react with sulfur and produce a fragile compound water solution, which may cause a gas leakage.

Therefore, use any other type of brazing filler at a hot spring resort, etc., and coat the surface with a paint.

2. When performing brazing again at time of servicing, use the same type of brazing filler.

#### 3-5-2. Flux

##### 1. Reason why flux is necessary

- By removing the oxide film and any foreign matter on the metal surface, it assists the flow of brazing filler.
- In the brazing process, it prevents the metal surface from being oxidized.
- By reducing the brazing filler's surface tension, the brazing filler adheres better to the treated metal.

## 2. Characteristics required for flux

- Activated temperature of flux coincides with the brazing temperature.
- Due to a wide effective temperature range, flux is hard to carbonize.
- It is easy to remove slag after brazing.
- The corrosive action to the treated metal and brazing filler is minimum.
- It excels in coating performance and is harmless to the human body.

As the flux works in a complicated manner as described above, it is necessary to select an adequate type of flux according to the type and shape of treated metal, type of brazing filler and brazing method, etc.

## 3. Types of flux

### • Noncorrosive flux

Generally, it is a compound of borax and boric acid. It is effective in case where the brazing temperature is higher than 800°C.

### • Activated flux

Most of fluxes generally used for silver brazing are this type.

It features an increased oxide film removing capability due to the addition of compounds such as potassium fluoride, potassium chloride and sodium fluoride to the borax-boric acid compound.

## 4. Piping materials for brazing and used brazing filler/flux

Piping material	Used brazing filler	Used flux
Copper - Copper	Phosphor copper	Do not use
Copper - Iron	Silver	Paste flux
Iron - Iron	Silver	Vapor flux

1. Do not enter flux into the refrigeration cycle.
2. When chlorine contained in the flux remains within the pipe, the lubricating oil deteriorates. Therefore, use a flux which does not contain chlorine.
3. When adding water to the flux, use water which does not contain chlorine (e.g. distilled water or ion-exchange water).
4. Remove the flux after brazing.

## 3-5-3. Brazing

As brazing work requires sophisticated techniques, experiences based upon a theoretical knowledge, it must be performed by a person qualified.

In order to prevent the oxide film from occurring in the pipe interior during brazing, it is effective to proceed with brazing while letting dry Nitrogen gas (N<sub>2</sub>) flow.

### Never use gas other than Nitrogen gas.

#### 1. Brazing method to prevent oxidation

- 1) Attach a reducing valve and a flow-meter to the Nitrogen gas cylinder.
- 2) Use a copper pipe to direct the piping material, and attach a flow-meter to the cylinder.
- 3) Apply a seal onto the clearance between the piping material and inserted copper pipe for Nitrogen in order to prevent backflow of the Nitrogen gas.
- 4) When the Nitrogen gas is flowing, be sure to keep the piping end open.
- 5) Adjust the flow rate of Nitrogen gas so that it is lower than 0.05 m<sup>3</sup>/Hr or 0.02 MPa (0.2kgf/cm<sup>2</sup>) by means of the reducing valve.
- 6) After performing the steps above, keep the Nitrogen gas flowing until the pipe cools down to a certain extent (temperature at which pipes are touchable with hands).
- 7) Remove the flux completely after brazing.

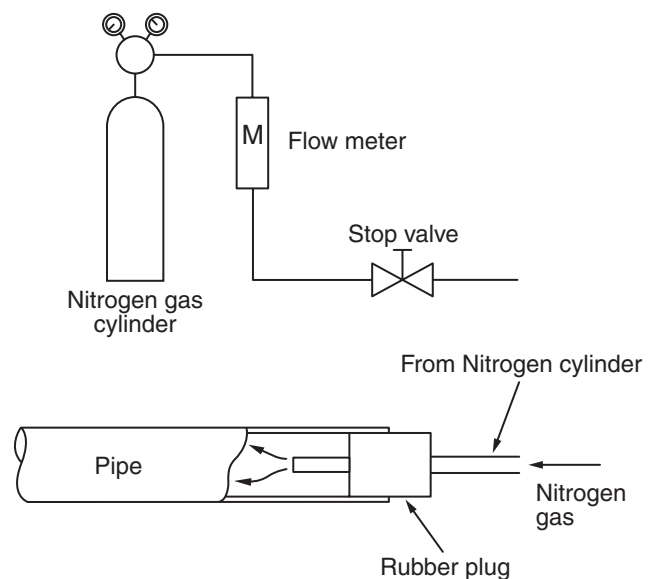

Fig. 3-5-1 Prevention of oxidation during brazing

# 4. CONSTRUCTION VIEWS

FILE NO. SVM-15074

## 4-1. Outdoor Unit

RAS-3M26S3AV-E, -A, -TR

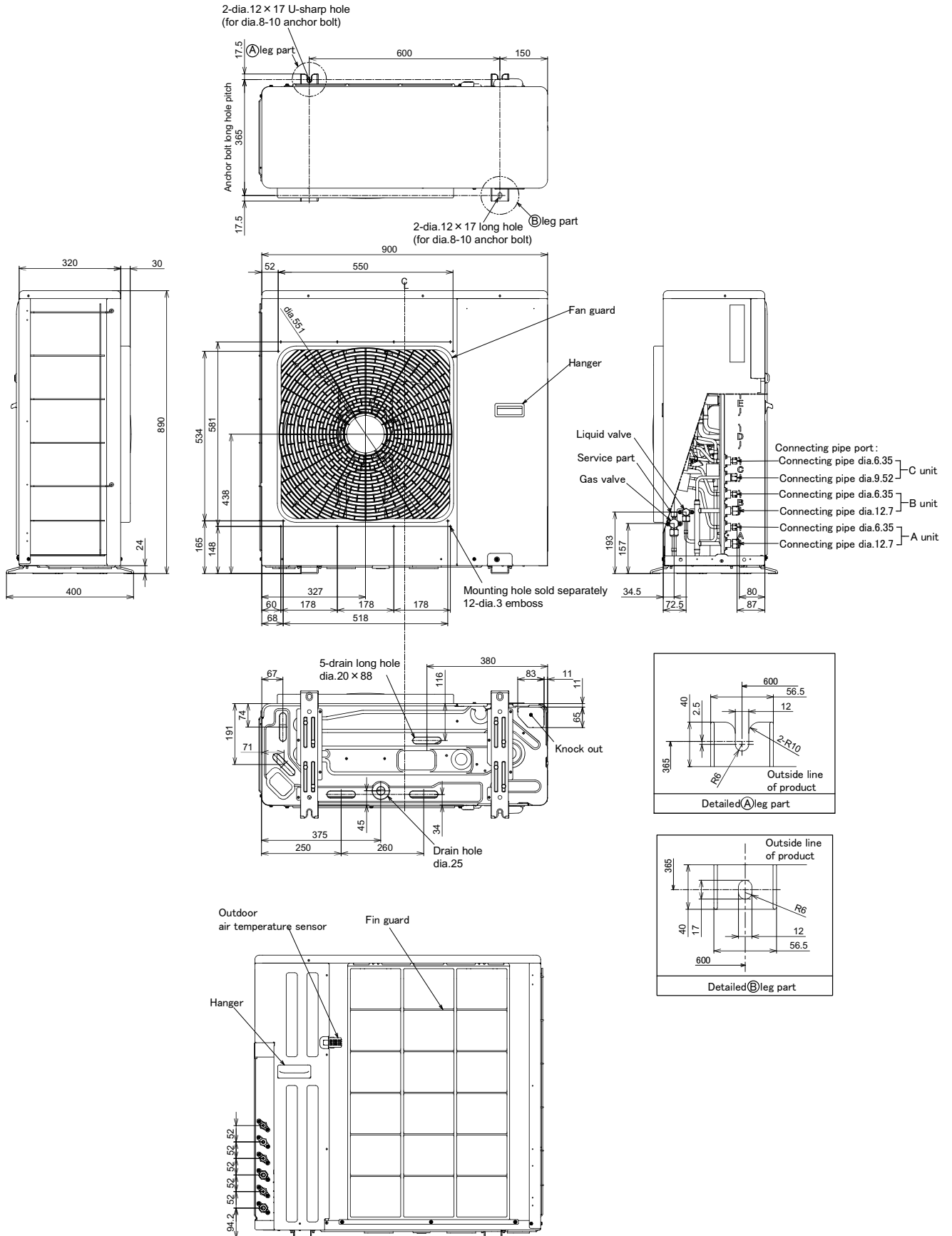

### 5. WIRING DIAGRAM

#### 5-1. Outdoor Unit RAS-3M26S3AV-A

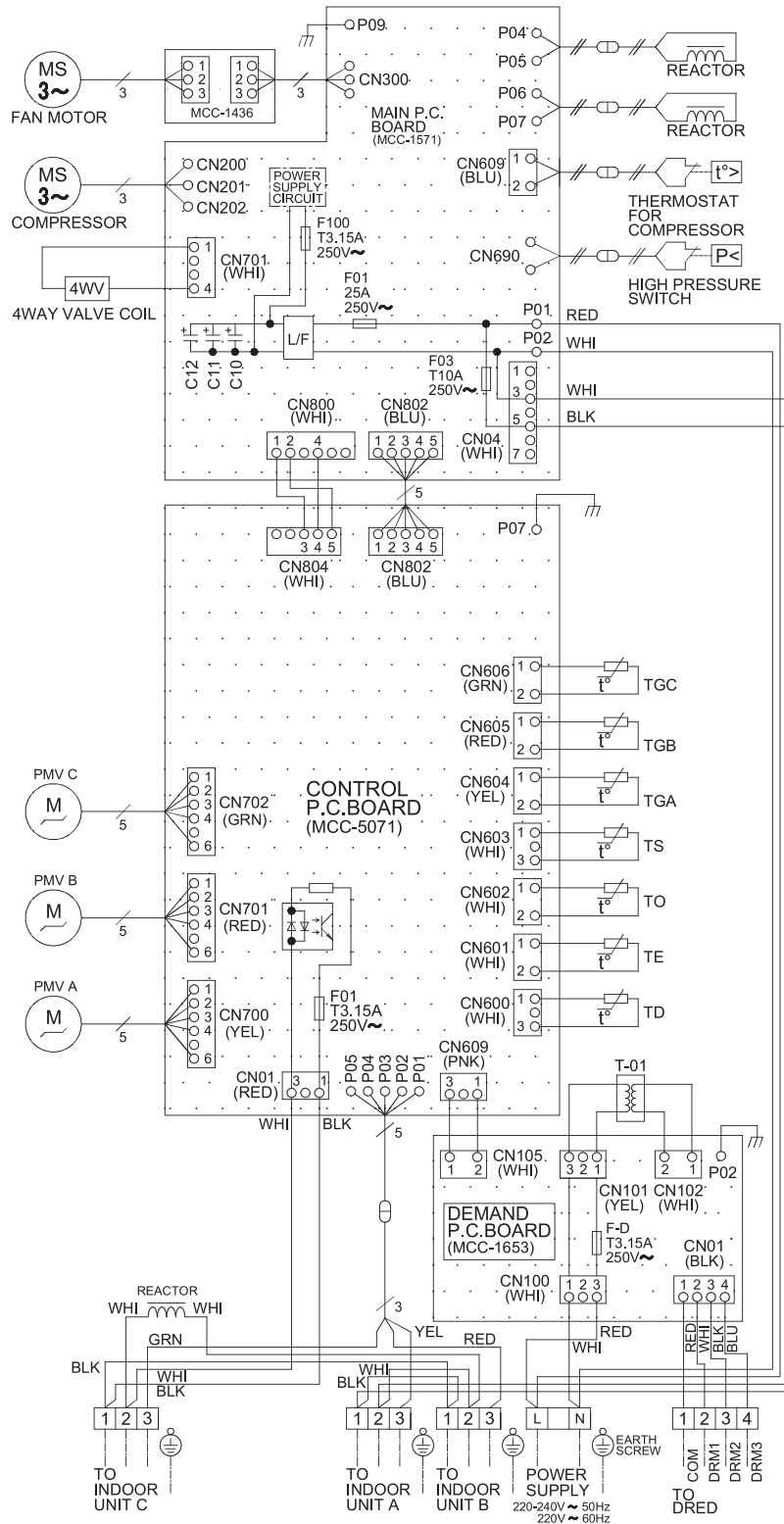

AS/NZS 4755 DRM1  DRM2  DRM3

COLOR IDENTIFICATION	
BLK:BLACK	GRN:GREEN
BLU:BLUE	WHI:WHITE
RED:RED	YEL:YELLOW
PNK:PINK	

Symbol	Part name
PMV	PULSE MOTOR VALVE
TD TE	DISCHARGE PIPE TEMP. SENSOR
TO TS	CONDENSER PIPE TEMP. SENSOR
	OUTDOOR TEMP. SENSOR
	SUCTION PIPE TEMP. SENSOR
TGA~TGC	GAS SIDE PIPE TEMP. SENSOR A~C
L / F	LINE FILTER

**5-2. Outdoor Unit**  
**RAS-3M26S3AV-E, -TR**

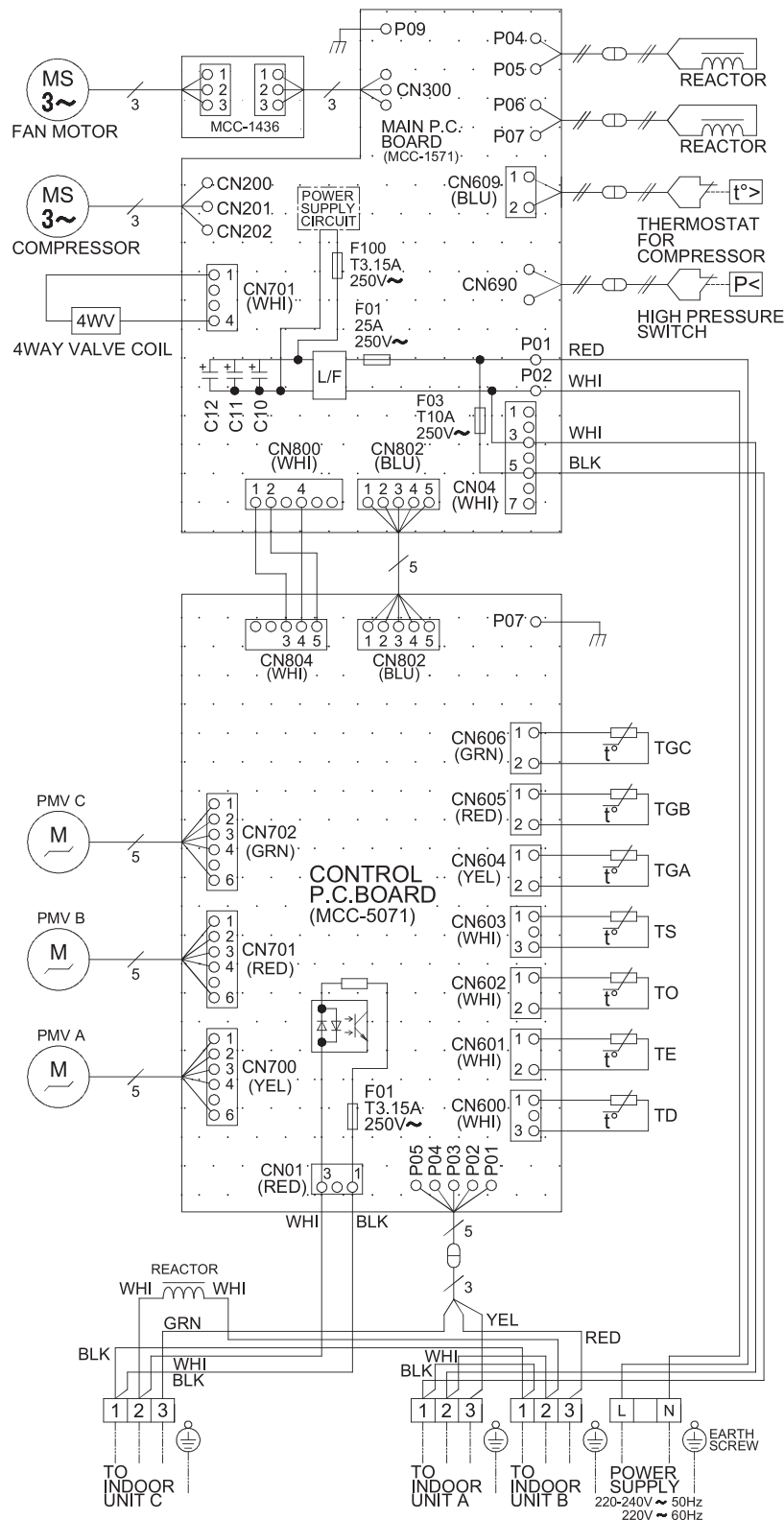

**COLOR IDENTIFICATION**

BLK:BLACK	GRN:GREEN
BLU:BLUE	WHI:WHITE
RED:RED	YEL:YELLOW

Symbol	Part name
PMV	PULSE MOTOR VALVE
TD	DISCHARGE PIPE TEMP. SENSOR
TE	CONDENSER PIPE TEMP. SENSOR
TO	OUTDOOR TEMP. SENSOR SUCTION
TS	PIPE TEMP. SENSOR
TGA ~ TGC	GAS SIDE PIPE TEMP. SENSOR A ~ C
L / F	LINE FILTER

### 5-3. Outdoor Unit

#### RAS-3M26S3AV-A

**Wiring between DRED (Demand response enabling device) and Outdoor Unit**  
**This model supports DRM1 DRM2 DRM3.**

AS/NZS 4755	DRM1 <input checked="" type="checkbox"/>	DRM2 <input checked="" type="checkbox"/>	DRM3 <input checked="" type="checkbox"/>
-------------	--	--	--

**■ Important notice**

- Install in accordance with the wiring rules (AS/NZS 3000).
- The precautions described below include important items regarding safety. Observe them without fail.
- The manufacturer shall not assume any liability for the damage caused by not observing the description of this manual.

**⚠ WARNING**

- **Turn off the main power supply switch or breaker before attempting installation. Make sure all power switches are off. Failure to do so may cause electric shock.**
- Connect the connecting wire correctly.  
 If the connecting wire is incorrect, electric parts may be damaged.
- Ensure that all terminals are securely fixed, so preventing any external forces having a negative effect on the terminals.
- **Do not connect the DRED mains cable to the terminal block of the outdoor unit (Power supply and Indoor/Outdoor connecting). Improper installation may result in fire.**
- **Connect the demand connecting wires and relay connector (RJ45) so that they do not come into contact with the refrigerant cycle parts or refrigerant pipes. Wire breakage or water intrusion may cause electric shock or fire.**
- **Do not screw the DRED signal receiver directly to the outdoor unit. The screw may damage the internal parts and cause an electric shock, fire or refrigerant leak.**

**⚠ CAUTION**

- **Wear heavy gloves during the installation work to avoid injury.**

**■ Connection procedure**

- This air conditioner complies with AS/NZS 4755.3.1.
- DRM available: DRM1, DRM2, DRM3
- The terminal block meets ELV requirements.

**⚠ WARNING**

- **Do not connect the DRED mains cable to the terminal block of the outdoor unit (Power supply and Indoor/Outdoor connecting). Improper installation may result in fire.**
- **For the power supply of the DRED, prepare exclusive power supply separated from that of the outdoor unit.**

**⚠ WARNING**

**Connect the wire (4-wire) with a round terminal to the Demand section (COM, DRM1, DRM2, DRM3) on the terminal block.**

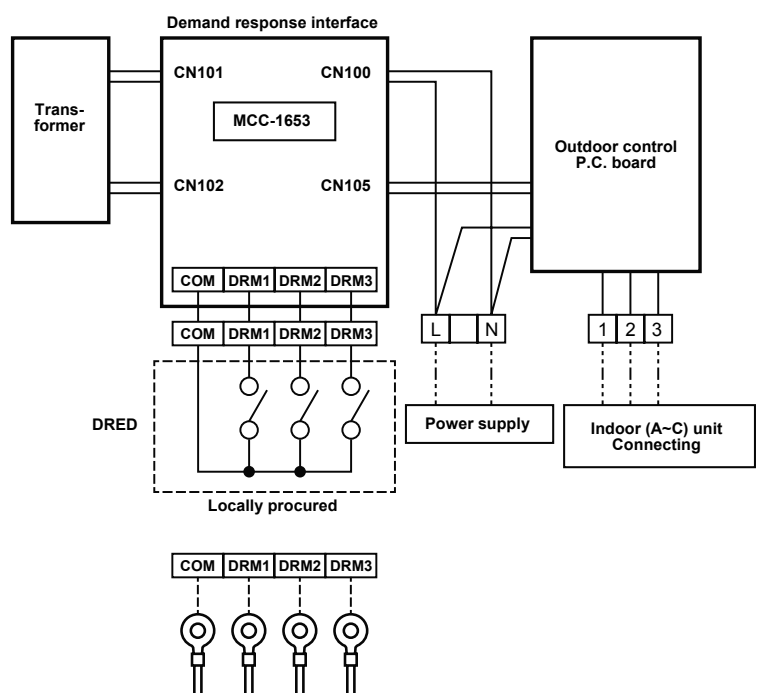



## Air conditioner demand response

Demand response mode	Description
DRM1	Compressor off
DRM2	$E_{30m} \leq R \times 0.50 \times 0.5$
DRM3	$E_{30m} \leq R \times 0.75 \times 0.5$

\*1:  $E_{30m}$  = total electrical energy (kWh) used by the air conditioner for all purposes (including compressors, controls and fans) over a 30 min period.

\*2: = rated input electrical power of the air conditioner (kW) at rated capacity in the mode in which it is operating during the demand response event (i.e. cooling or heating).

### ■ Wiring procedure

- Securely fasten the demand connecting wires with the cord clamp located at the upper portion of the terminal block so that no external force is applied to the terminal.  
\* The demand connecting wires having a relay connector (RJ45) should be wired in such a manner as to prevent water intrusion into the relay connector.
- Bundle the demand connecting wires with indoor/outdoor connecting wires using a fixing band (locally procured).

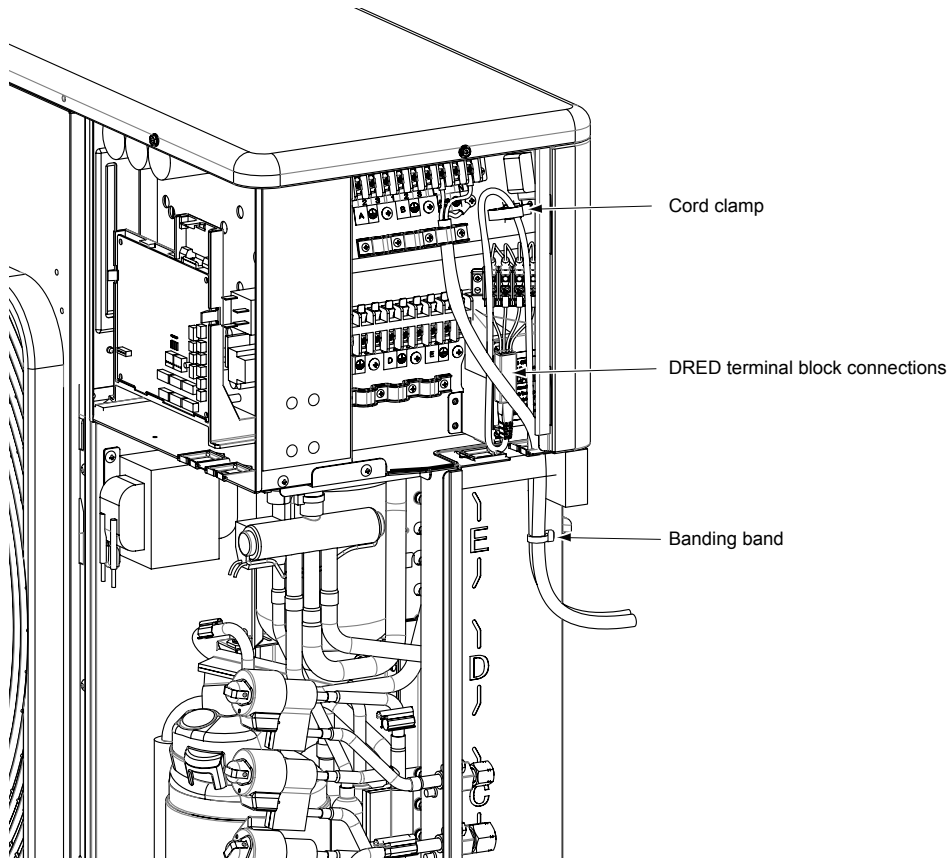

## 6. SPECIFICATIONS OF ELECTRICAL PARTS

### 6-1. Outdoor Unit

#### RAS-3M26S3AV-E, -A, -TR

No.	Parts name	Model name	Rating
1	Compressor	DA220A2T-20LD	—
2	Outdoor fan motor	ICF-280-A60-1	Output 60 W
3	Reactor	CH-56-3Z-T	5.8 mH, 18.5 A
4	Reactor	CH-76-TM1	9.9 mH, 1 A
5	4-way valve coil	5TF-H01AP1874A1	AC 200–240 V
6	PMV coil	UKV-A039	DC 12 V
7	P.C. board (Main PCB)	MCC-1571	AC 220–240 V
8	P.C. board (Control PCB)	MCC-5071	AC 220–240 V
9	P.C. board (Fan motor connection)	MCC-1436	AC 220–240V
10	Fuse (Mounted on P.C. board MCC-1571)	—	AC 250V, 25 A
11	Fuse (Mounted on P.C. board MCC-1571)	—	AC 250V, 10 A
12	Fuse (Mounted on P.C. board MCC-1571, MCC-5071)	—	AC 250V, 3.15 A
13	Outdoor temp. sensor (TO sensor)	—	10 k $\Omega$ (25°C)
14	Evaporator temp. sensor (Te sensor)	—	10 k $\Omega$ (25°C)
15	Discharge temp. sensor (Td sensor)	—	50 k $\Omega$ (25°C)
16	Suction temp. sensor (Ts sensor)	—	10 k $\Omega$ (25°C)
17	Temp. sensor at A room gas side (TGa-sensor)	—	10 k $\Omega$ (25°C)
18	Temp. sensor at B room gas side (TGb-sensor)	—	10 k $\Omega$ (25°C)
19	Temp. sensor at C room gas side (TGc-sensor)	—	10 k $\Omega$ (25°C)
20	Compressor thermo.	CS-12AL	ON: 90°C, OFF: 125°C
21	Terminal block (9P)	—	AC 250 V, 20 A

## 7. REFRIGERANT CYCLE DIAGRAM

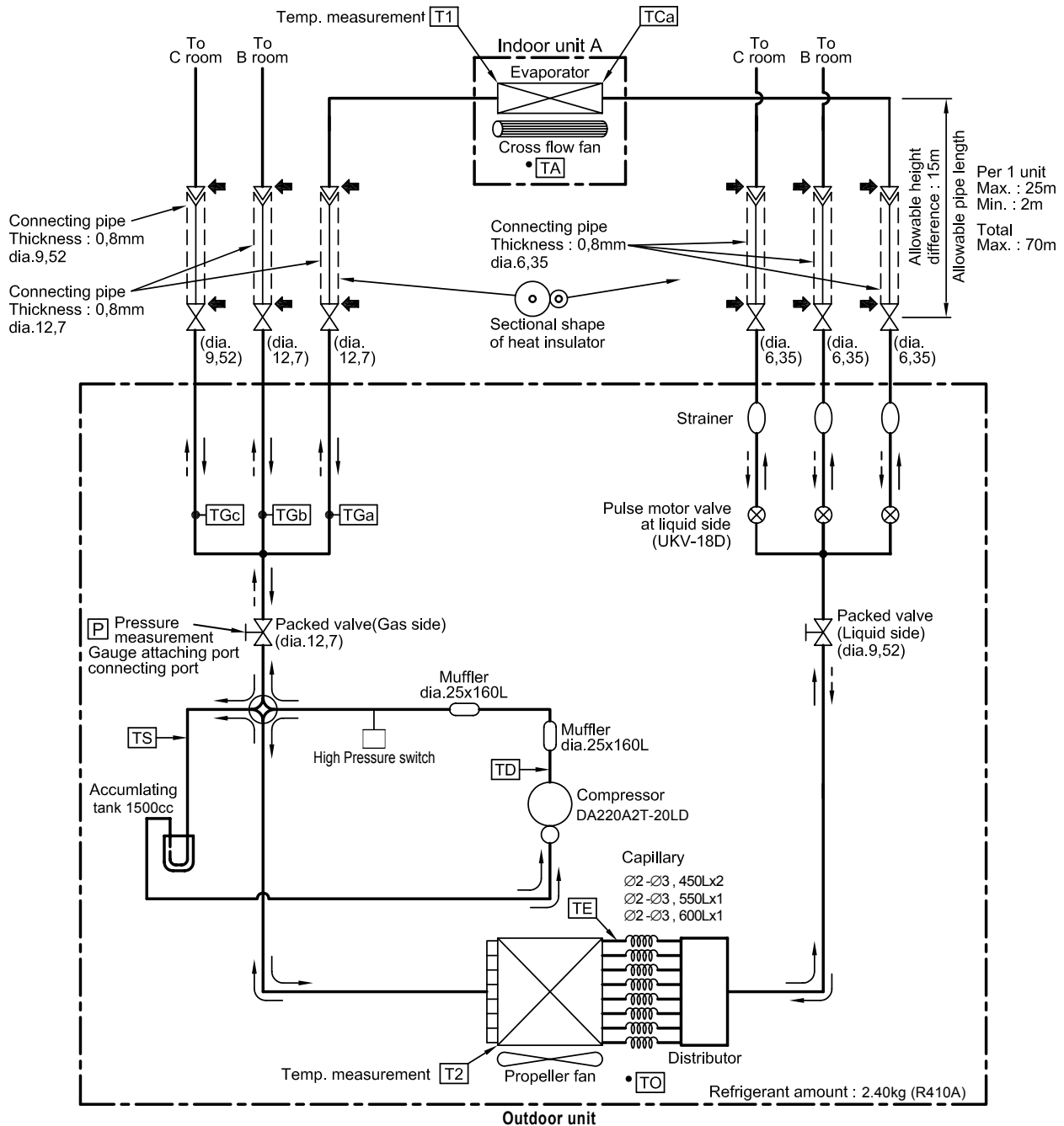

### NOTE :

- You need not add refrigerant if the piping length is 40m or less.
- If the length exceeds 41m, add 20g of refrigerant per 1 meter over.
- Connection of only one indoor unit is unavailable. Two or more indoor units should be connected.

7-2. Operation Data

Outdoor Unit: RAS-3M26S3AV-E, -A, -TR

<Cooling>

Temperature condition		No. of operating units	Indoor unit			Standard pressure	Heat exchanger pipe temperature		Indoor fan	Outdoor fan	Compressor revolution (rps)	
Indoor	Outdoor		A	B	C	P (MP)	T1 (°C)	T2 (°C)				
27/19	35/-	1 unit	07	-	-	0.9 to 1.1	15 to 17	36 to 42	High	LOW	15.6	
			10	-	-	0.8 to 1.0	12 to 14	36 to 42	High	MED	23.3	
			13	-	-	0.7 to 0.9	10 to 12	36 to 44	High	MED	36.5	
			16	-	-	0.6 to 0.8	9 to 11	36 to 46	High	MED	50.3	
			18	-	-	0.6 to 0.8	10 to 12	36 to 47	High	High	52.1	
			22	-	-	0.6 to 0.8	8 to 10	36 to 47	High	High	52.7	
			24	-	-	0.6 to 0.8	8 to 10	36 to 47	High	High	70.0	
		2 units	07	07	-	0.8 to 1.0	10 to 12	47 to 49	High	MED	42.5	
			10	07	-	0.8 to 1.0	10 to 12	47 to 49	High	MED	42.5	
			13	07	-	0.8 to 1.0	10 to 12	47 to 49	High	MED	45.8	
			16	07	-	0.8 to 1.0	10 to 12	47 to 49	High	MED	49.1	
			18	07	-	0.8 to 1.0	10 to 12	47 to 49	High	High	52.3	
			22	07	-	0.8 to 1.0	10 to 12	49 to 51	High	High	55.6	
			24	07	-	0.7 to 0.9	9 to 11	51 to 53	High	High	58.9	
			10	10	-	0.8 to 1.0	10 to 12	47 to 49	High	MED	42.5	
			13	10	-	0.8 to 1.0	10 to 12	47 to 49	High	MED	49.1	
			16	10	-	0.8 to 1.0	10 to 12	49 to 51	High	High	52.3	
			18	10	-	0.8 to 1.0	10 to 12	49 to 51	High	High	55.6	
			22	10	-	0.7 to 0.9	9 to 11	51 to 53	High	High	58.9	
			24	10	-	0.7 to 0.9	9 to 11	51 to 53	High	High	62.2	
			13	13	-	0.8 to 1.0	10 to 12	47 to 49	High	High	55.6	
			16	13	-	0.7 to 0.9	9 to 11	51 to 53	High	High	58.9	
			18	13	-	0.7 to 0.9	9 to 11	51 to 53	High	High	62.2	
			22	13	-	0.7 to 0.9	9 to 11	51 to 53	High	High	62.2	
			24	13	-	0.7 to 0.9	9 to 11	51 to 53	High	High	62.2	
			16	16	-	0.7 to 0.9	9 to 11	52 to 54	High	High	62.2	
			18	16	-	0.7 to 0.9	9 to 11	52 to 54	High	High	62.2	
			22	16	-	0.7 to 0.9	9 to 11	52 to 54	High	High	62.2	
			24	16	-	0.7 to 0.9	9 to 11	52 to 54	High	High	62.2	
			18	18	-	0.7 to 0.9	9 to 11	52 to 54	High	High	62.2	
			22	18	-	0.7 to 0.9	9 to 11	52 to 54	High	High	62.2	
			24	18	-	0.7 to 0.9	9 to 11	52 to 54	High	High	62.2	
			3 units	07	07	07	0.8 to 1.0	11 to 13	51 to 53	High	High	59.8
				10	07	07	0.8 to 1.0	11 to 13	51 to 53	High	High	59.8
				13	07	07	0.8 to 1.0	11 to 13	51 to 53	High	High	59.8
		16		07	07	0.8 to 1.0	11 to 13	51 to 53	High	High	59.8	
		18		07	07	0.8 to 1.0	11 to 13	51 to 53	High	High	59.8	
		22		07	07	0.8 to 1.0	11 to 13	51 to 53	High	High	59.8	
		24		07	07	0.8 to 1.0	11 to 13	51 to 53	High	High	59.8	
		10		10	07	0.8 to 1.0	11 to 13	51 to 53	High	High	59.8	
		13		10	07	0.8 to 1.0	11 to 13	51 to 53	High	High	59.8	
		16		10	07	0.8 to 1.0	11 to 13	51 to 53	High	High	59.8	
		18		10	07	0.8 to 1.0	11 to 13	51 to 53	High	High	59.8	
		22		10	07	0.8 to 1.0	11 to 13	51 to 53	High	High	59.8	
		24		10	07	0.8 to 1.0	11 to 13	51 to 53	High	High	59.8	
		13	13	07	0.8 to 1.0	11 to 13	51 to 53	High	High	59.8		
		16	13	07	0.8 to 1.0	11 to 13	51 to 53	High	High	59.8		
		18	13	07	0.8 to 1.0	11 to 13	51 to 53	High	High	59.8		
22	13	07	0.8 to 1.0	11 to 13	51 to 53	High	High	59.8				
24	13	07	0.8 to 1.0	11 to 13	51 to 53	High	High	59.8				
16	16	07	0.8 to 1.0	11 to 13	51 to 53	High	High	59.8				

NOTES:

1. Measure surface temperature of heat exchanger pipe around of heat exchanger path U bent. (Thermistor thermometer)
2. Connecting piping condition : 5 meters × 3 units (5 m / each indoor unit)

<Cooling> (Continued)

Temperature condition		No. of operating units	Indoor unit			Standard pressure	Heat exchanger pipe temperature		Indoor fan	Outdoor fan	Compressor revolution (rps)
Indoor	Outdoor		A	B	C	P (MP)	T1 (°C)	T2 (°C)			
27/19	35/-	3 units	18	16	07	0.8 to 1.0	11 to 13	51 to 53	High	High	59.8
			22	16	07	0.8 to 1.0	11 to 13	51 to 53	High	High	59.8
			24	16	07	0.8 to 1.0	11 to 13	51 to 53	High	High	59.8
			10	10	10	0.8 to 1.0	11 to 13	51 to 53	High	High	59.8
			13	10	10	0.8 to 1.0	11 to 13	51 to 53	High	High	59.8
			16	10	10	0.8 to 1.0	11 to 13	51 to 53	High	High	59.8
			18	10	10	0.8 to 1.0	11 to 13	51 to 53	High	High	59.8
			22	10	10	0.8 to 1.0	11 to 13	51 to 53	High	High	59.8
			24	10	10	0.8 to 1.0	11 to 13	51 to 53	High	High	59.8
			13	13	10	0.8 to 1.0	11 to 13	51 to 53	High	High	59.8
			16	13	10	0.8 to 1.0	11 to 13	51 to 53	High	High	59.8
			18	13	10	0.8 to 1.0	11 to 13	51 to 53	High	High	59.8
			22	13	10	0.8 to 1.0	11 to 13	51 to 53	High	High	59.8
			24	13	10	0.8 to 1.0	11 to 13	51 to 53	High	High	59.8
			16	16	10	0.8 to 1.0	11 to 13	51 to 53	High	High	59.8
			18	16	10	0.8 to 1.0	11 to 13	51 to 53	High	High	59.8
			22	16	10	0.8 to 1.0	11 to 13	51 to 53	High	High	59.8
			24	16	10	0.8 to 1.0	11 to 13	51 to 53	High	High	59.8
			13	13	13	0.8 to 1.0	11 to 13	51 to 53	High	High	59.8
			16	13	13	0.8 to 1.0	11 to 13	51 to 53	High	High	59.8
			18	13	13	0.8 to 1.0	11 to 13	51 to 53	High	High	59.8
			22	13	13	0.8 to 1.0	11 to 13	51 to 53	High	High	59.8
			24	13	13	0.8 to 1.0	11 to 13	51 to 53	High	High	59.8
			16	16	13	0.8 to 1.0	11 to 13	51 to 53	High	High	59.8
			18	16	13	0.8 to 1.0	11 to 13	51 to 53	High	High	59.8
			22	16	13	0.8 to 1.0	11 to 13	51 to 53	High	High	59.8
24	16	13	0.8 to 1.0	11 to 13	51 to 53	High	High	59.8			
16	16	16	0.8 to 1.0	11 to 13	51 to 53	High	High	59.8			
18	16	16	0.8 to 1.0	11 to 13	51 to 53	High	High	59.8			
22	16	16	0.8 to 1.0	11 to 13	51 to 53	High	High	59.8			

**NOTES:**

1. Measure surface temperature of heat exchanger pipe around of heat exchanger path U bent. (Thermistor thermometer)
2. Connecting piping condition : 5 meters × 3 units (5 m / each indoor unit)

**Outdoor Unit : RAS-3M26S3AV-E, -A, -TR**  
**<Heating>**

Temperature condition		No. of operating units	Indoor unit			Standard pressure	Heat exchanger pipe temperature		Indoor fan	Outdoor fan	Compressor revolution (rps)	
Indoor	Outdoor		A	B	C	P (MP)	T1 (°C)	T2 (°C)				
20/-	7/6	1 unit	07	-	-	2.1 to 2.3	36 to 38	3 to 5	High	MED	29.9	
			10	-	-	2.7 to 2.9	44 to 46	2 to 4	High	High	44.3	
			13	-	-	3.2 to 3.4	52 to 54	2 to 4	High	High	53.9	
			16	-	-	3.6 to 3.9	53 to 55	2 to 4	High	High	55.6	
			18	-	-	3.6 to 3.9	53 to 55	2 to 4	High	High	59.8	
			22	-	-	3.6 to 3.9	53 to 55	2 to 4	High	High	67.6	
		2 units	24	-	-	3.6 to 3.9	53 to 55	2 to 4	High	High	78.4	
			07	07	-	2.8 to 3.0	45 to 47	0 to 2	High	High	62.2	
			10	07	-	2.8 to 3.0	45 to 47	0 to 2	High	High	62.2	
			13	07	-	2.8 to 3.0	45 to 47	0 to 2	High	High	63.7	
			16	07	-	2.8 to 3.0	45 to 47	0 to 2	High	High	65.2	
			18	07	-	2.9 to 3.1	46 to 48	0 to 2	High	High	66.7	
			22	07	-	2.9 to 3.1	46 to 48	0 to 2	High	High	68.2	
			24	07	-	3.0 to 3.2	47 to 49	-1 to 1	High	High	69.7	
			10	10	-	2.8 to 3.0	45 to 47	0 to 2	High	High	62.2	
			13	10	-	2.8 to 3.0	45 to 47	0 to 2	High	High	65.2	
			16	10	-	2.9 to 3.1	46 to 48	0 to 2	High	High	66.7	
			18	10	-	2.9 to 3.1	46 to 48	0 to 2	High	High	68.2	
			22	10	-	3.0 to 3.2	47 to 49	-1 to 1	High	High	69.7	
			24	10	-	3.1 to 3.3	48 to 50	-1 to 1	High	High	71.2	
			13	13	-	2.8 to 3.0	45 to 47	0 to 2	High	High	68.2	
			16	13	-	3.0 to 3.2	47 to 49	-1 to 1	High	High	69.7	
			18	13	-	3.1 to 3.3	48 to 50	-1 to 1	High	High	71.2	
			22	13	-	3.1 to 3.3	48 to 50	-1 to 1	High	High	71.2	
			24	13	-	3.1 to 3.3	48 to 50	-1 to 1	High	High	71.2	
			16	16	-	3.1 to 3.3	48 to 50	-1 to 1	High	High	71.2	
			18	16	-	3.1 to 3.3	48 to 50	-1 to 1	High	High	71.2	
			22	16	-	3.1 to 3.3	48 to 50	-1 to 1	High	High	71.2	
			24	16	-	3.1 to 3.3	48 to 50	-1 to 1	High	High	71.2	
			18	18	-	3.1 to 3.3	48 to 50	-1 to 1	High	High	71.2	
			22	18	-	3.1 to 3.3	48 to 50	-1 to 1	High	High	71.2	
			24	18	-	3.1 to 3.3	48 to 50	-1 to 1	High	High	71.2	
			3 units	07	07	07	2.3 to 2.5	38 to 40	-1 to 1	High	High	71.8
				10	07	07	2.3 to 2.5	38 to 40	-1 to 1	High	High	71.8
				13	07	07	2.3 to 2.5	38 to 40	-1 to 1	High	High	71.8
				16	07	07	2.3 to 2.5	38 to 40	-1 to 1	High	High	72.0
		18		07	07	2.3 to 2.5	38 to 40	-1 to 1	High	High	72.2	
		22		07	07	2.3 to 2.5	38 to 40	-1 to 1	High	High	72.4	
		24		07	07	2.3 to 2.5	38 to 40	-1 to 1	High	High	72.6	
		10		10	07	2.3 to 2.5	38 to 40	-1 to 1	High	High	71.8	
		13		10	07	2.3 to 2.5	38 to 40	-1 to 1	High	High	72.0	
		16		10	07	2.3 to 2.5	38 to 40	-1 to 1	High	High	72.2	
		18		10	07	2.5 to 2.7	37 to 39	-2 to 0	High	High	72.4	
		22		10	07	2.3 to 2.5	38 to 40	-1 to 1	High	High	72.6	
		24		10	07	2.3 to 2.5	38 to 40	-1 to 1	High	High	72.8	
13	13	07		2.5 to 2.7	37 to 39	-2 to 0	High	High	72.4			
16	13	07		2.5 to 2.7	37 to 39	-2 to 0	High	High	72.6			
18	13	07		2.5 to 2.7	37 to 39	-2 to 0	High	High	72.8			
22	13	07		2.5 to 2.7	37 to 39	-2 to 0	High	High	73.0			
24	13	07		2.5 to 2.7	37 to 39	-2 to 0	High	High	73.0			
16	16	07	2.5 to 2.7	37 to 39	-2 to 0	High	High	72.8				
18	16	07	2.5 to 2.7	37 to 39	-2 to 0	High	High	73.0				

**NOTES:**

1. Measure surface temperature of heat exchanger pipe around of heat exchanger path U bent. (Thermistor thermometer)
2. Connecting piping condition : 5 meters × 3 units (5 m / each indoor unit)

<Heating> (Continued)

Temperature condition		No. of operating units	Indoor unit			Standard pressure	Heat exchanger pipe temperature		Indoor fan	Outdoor fan	Compressor revolution (rps)
Indoor	Outdoor		A	B	C	P (MP)	T1 (°C)	T2 (°C)			
20/-	7/6	3 units	22	16	07	2.5 to 2.7	37 to 39	-2 to 0	High	High	73.0
			24	16	07	2.5 to 2.7	37 to 39	-2 to 0	High	High	73.0
			10	10	10	2.3 to 2.5	38 to 40	-1 to 1	High	High	71.8
			13	10	10	2.3 to 2.5	38 to 40	-1 to 1	High	High	72.2
			16	10	10	2.5 to 2.7	37 to 39	-2 to 0	High	High	72.4
			18	10	10	2.5 to 2.7	37 to 39	-2 to 0	High	High	72.6
			22	10	10	2.5 to 2.7	37 to 39	-2 to 0	High	High	72.8
			24	10	10	2.5 to 2.7	37 to 39	-2 to 0	High	High	73.0
			13	13	10	2.5 to 2.7	37 to 39	-2 to 0	High	High	72.6
			16	13	10	2.5 to 2.7	37 to 39	-2 to 0	High	High	72.8
			18	13	10	2.5 to 2.7	37 to 39	-2 to 0	High	High	73.0
			22	13	10	2.5 to 2.7	37 to 39	-2 to 0	High	High	73.0
			24	13	10	2.5 to 2.7	37 to 39	-2 to 0	High	High	73.0
			16	16	10	2.5 to 2.7	37 to 39	-2 to 0	High	High	73.0
			18	16	10	2.5 to 2.7	37 to 39	-2 to 0	High	High	73.0
			22	16	10	2.5 to 2.7	37 to 39	-2 to 0	High	High	73.0
			24	16	10	2.5 to 2.7	37 to 39	-2 to 0	High	High	73.0
			13	13	13	2.5 to 2.7	37 to 39	-2 to 0	High	High	73.0
			16	13	13	2.5 to 2.7	37 to 39	-2 to 0	High	High	73.0
			18	13	13	2.5 to 2.7	37 to 39	-2 to 0	High	High	73.0
			22	13	13	2.5 to 2.7	37 to 39	-2 to 0	High	High	73.0
			24	13	13	2.5 to 2.7	37 to 39	-2 to 0	High	High	73.0
			16	16	13	2.5 to 2.7	37 to 39	-2 to 0	High	High	73.0
			18	16	13	2.5 to 2.7	37 to 39	-2 to 0	High	High	73.0
			22	16	13	2.5 to 2.7	37 to 39	-2 to 0	High	High	73.0
			24	16	13	2.5 to 2.7	37 to 39	-2 to 0	High	High	73.0
16	16	16	2.5 to 2.7	37 to 39	-2 to 0	High	High	73.0			
18	16	16	2.5 to 2.7	37 to 39	-2 to 0	High	High	73.0			
22	16	16	2.5 to 2.7	37 to 39	-2 to 0	High	High	73.0			

**NOTES:**

1. Measure surface temperature of heat exchanger pipe around of heat exchanger path U bent. (Thermistor thermometer)
2. Connecting piping condition : 5 meters × 3 units (5 m / each indoor unit)

### 8. CONTROL BLOCK DIAGRAM

#### 8-1. Outdoor Unit (Inverter Assembly)

RAS-3M26S3AV-A

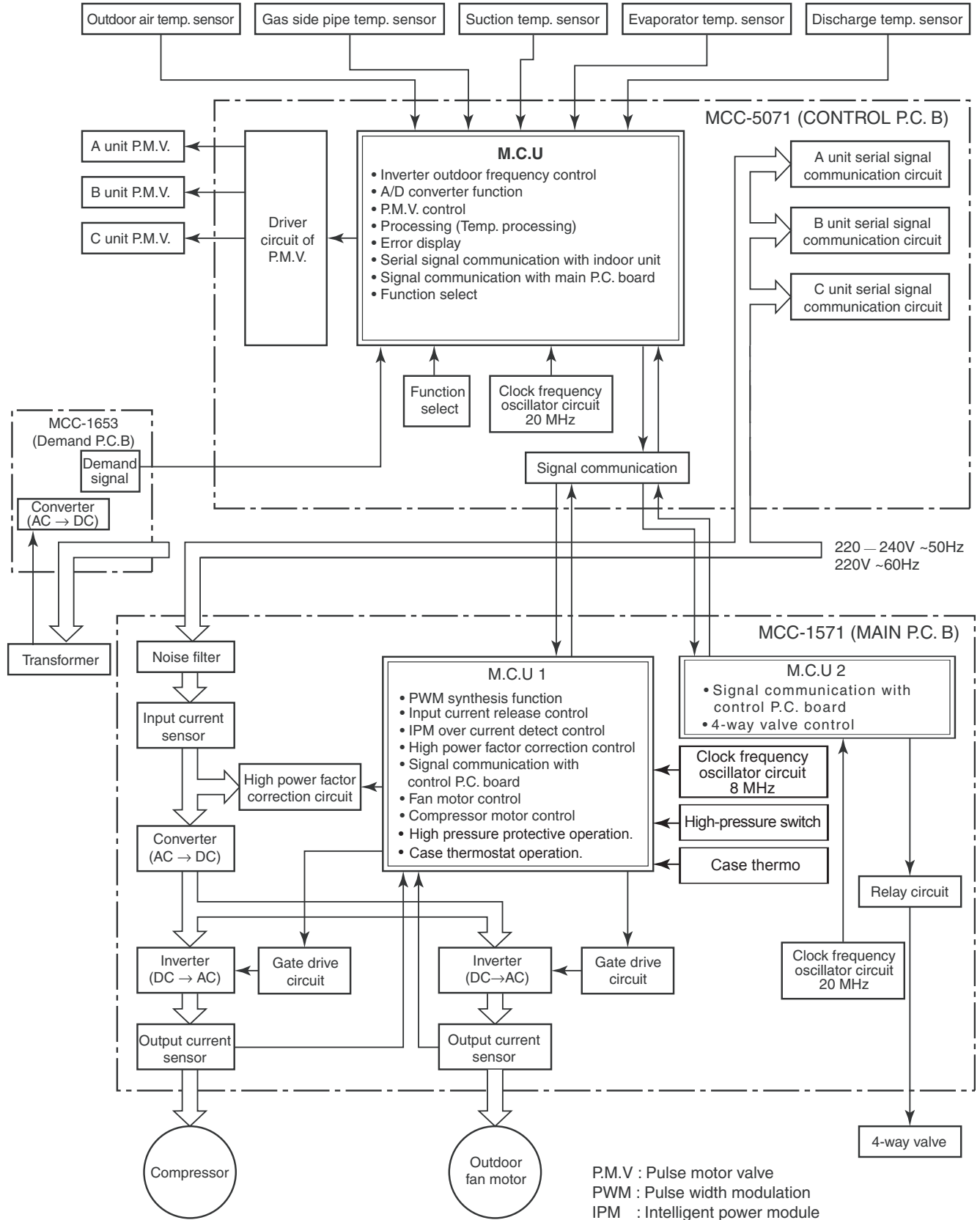



8-2. Outdoor Unit (Inverter Assembly)

RAS-3M26S3AV-E, -TR

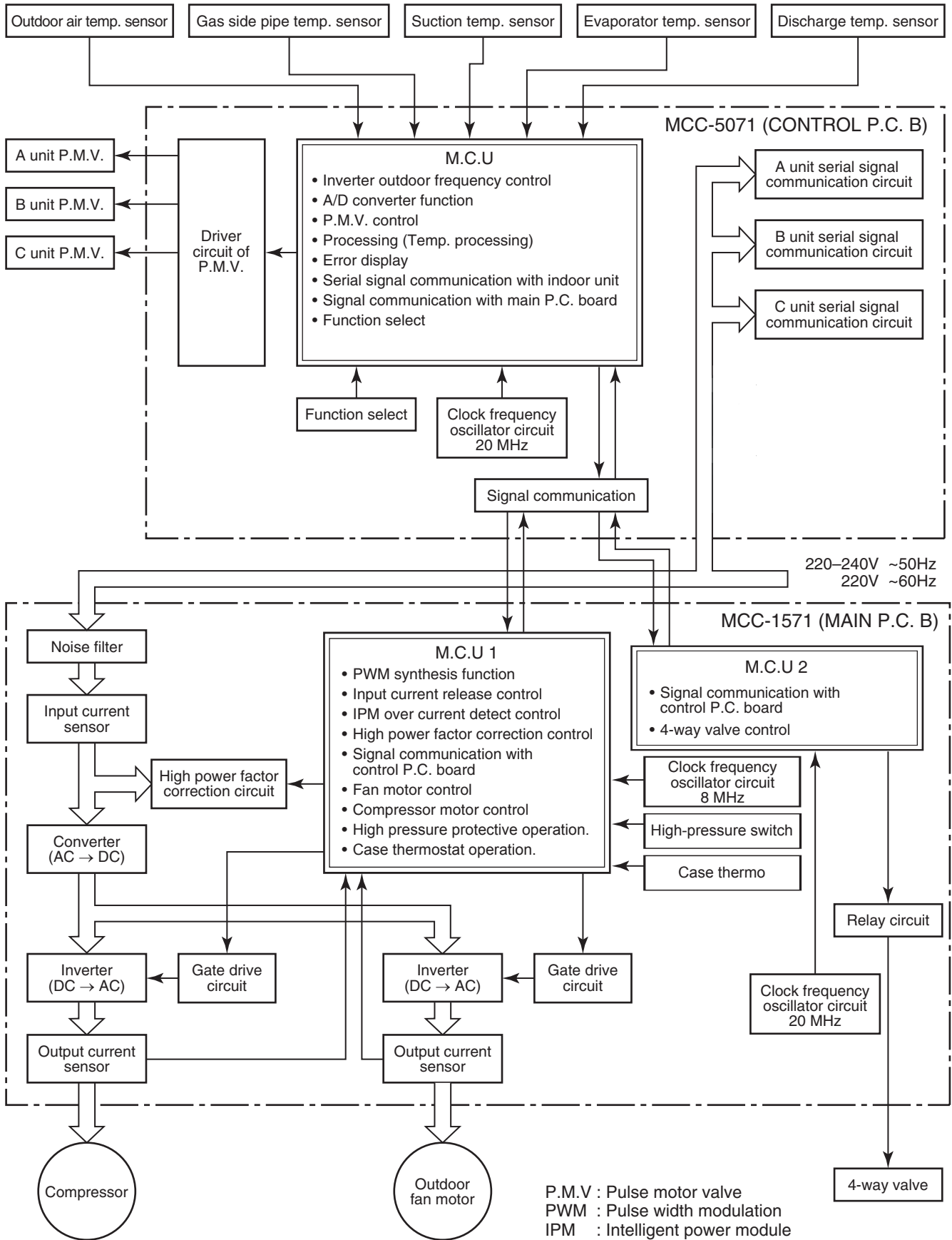

## 9. OPERATION DESCRIPTION

### 9-1. Outline of Air Conditioner Control

This air conditioner is a capacity-variable type air conditioner, which uses DC motor for the indoor fan motor and the outdoor fan motor. And the capacity-proportional control compressor which can change the motor speed in the range from 12 to 100 rps is mounted.

The DC motor drive circuit is mounted to the indoor unit. The compressor and the inverter to control fan motor are mounted to the outdoor unit.

The entire air conditioner is mainly controlled by the indoor unit controller.

The indoor unit controller drives the indoor fan motor based upon command sent from the remote controller, and transfers the operation command to the outdoor unit controller.

The outdoor unit controller receives operation command from the indoor unit side, and controls the outdoor fan and the pulse motor valve. (PMV)

Besides, detecting revolution position of the compressor motor, the outdoor unit controller controls speed of the compressor motor by controlling output voltage of the inverter and switching timing of the supply power (current transfer timing) so that motors drive according to the operation command.

And then, the outdoor unit controller transfers reversely the operating status information of the outdoor unit to control the indoor unit controller.

---

**As the compressor adopts four-pole brushless DC motor, the frequency of the supply power from inverter to compressor is two-times cycles of the actual number of revolution.**

---

#### 1. Role of indoor unit controller

The indoor unit controller judges the operation commands from the remote controller and assumes the following functions.

- Judgment of suction air temperature of the indoor heat exchanger by using the indoor temp. sensor. (TA sensor)
- Judgment of the indoor heat exchanger temperature by using heat exchanger sensor (TC sensor) (Prevent-freezing control, etc.)
- Louver motor control
- Indoor fan motor operation control
- LED (Light Emitting Diode) display control
- Transferring of operation command signal (Serial signal) to the outdoor unit
- Reception of information of operation status (Serial signal including outside temp. data) to the outdoor unit and judgment/display of error
- Air purifier operation control

#### 2. Role of outdoor unit controller

Receiving the operation command signal (Serial signal) from the indoor unit controller, the outdoor unit performs its role.

- Compressor operation control
  - Operation control of outdoor fan motor
  - P.M.V. control
  - 4-way valve control
- } Operations followed to judgment of serial signal from indoor side.

- Detection of inverter input current and current release operation
- Over-current detection and prevention operation to IGBT module (Compressor stop function)
- Compressor and outdoor fan stop function when serial signal is off (when the serial signal does not reach the board assembly of outdoor control by trouble of the signal system)
- Transferring of operation information (Serial signal) from outdoor unit controller to indoor unit controller
- Detection of outdoor temperature and operation revolution control
- Defrost control in heating operation (Temp. measurement by outdoor heat exchanger and control for 4-way valve and outdoor fan)

#### 3. Contents of operation command signal (Serial signal) from indoor unit controller to outdoor unit controller

The following three types of signals are sent from the indoor unit controller.

- Operation mode set on the remote controller
- Compressor revolution command signal defined by indoor temperature and set temperature (Correction along with variation of room temperature and correction of indoor heat exchanger temperature are added.)
- Temperature of indoor heat exchanger
- For these signals ([Operation mode] and [Compressor revolution] indoor heat exchanger temperature), the outdoor unit controller monitors the input current to the inverter, and performs the followed operation within the range that current does not exceed the allowable value.

#### 4. Contents of operation command signal (Serial signal) from outdoor unit controller to indoor unit controller

The following signals are sent from the outdoor unit controller.

- The current operation mode
  - The current compressor revolution
  - Outdoor temperature
  - Existence of protective circuit operation
- For transferring of these signals, the indoor unit controller monitors the contents of signals, and judges existence of trouble occurrence. Contents of judgment are described below.
- Whether distinction of the current operation status meets to the operation command signal
  - Whether protective circuit operates
- When no signal is received from the outdoor unit controller, it is assumed as a trouble.

**9-2. Operation Description**

1. Basic operation .....	52
1. Operation control .....	52
2. Operating mode selection when performing 2-room operation .....	53
3. Cooling/Heating operation .....	53
2. Outdoor fan motor control .....	54
3. Capacity control .....	55
4. Current release control .....	55
5. Winding/Coil heating control .....	56
6. Defrost control (Only in heating operation) .....	56
7. Compressor protective control .....	56
8. Discharge temperature control .....	57
9. Pulse motor valve (PMV) control .....	57
10. High-pressure switch/Compressor case thermostat control .....	57
11. Various setting on outdoor unit (Power save, Cooling-only, etc.) .....	58

**9-3. Intermittent Operation Control for Indoor Fans of the Indoor Unit  
at Thermo-off Side in Heating Operation..... 58**

Item	Operation flow and applicable data, etc.	Description
<p>1. Basic operation</p>	<p><b>1. Operation control</b></p> <p>Receiving the user's operation condition setup, the operation statuses of indoor/outdoor units are controlled.</p> <ol style="list-style-type: none"> <li>1) The operation conditions are selected by the remote controller as shown in the below.</li> <li>2) A signal is sent by ON button of the remote controller.</li> <li>3) The signal is received by a sensor of the indoor unit and processed by the indoor controllers as shown in the below.</li> <li>4) The indoor controller controls the indoor fan motor and louver motor.</li> <li>5) The indoor controller sends the operation command to the outdoor controller, and sends/receives the control status with a serial signal.</li> <li>6) The outdoor controller controls the operation as shown in the below, and also controls the compressor, outdoor fan motor, 4-way valve and pulse motor valve.</li> </ol>	

**Remote controller**

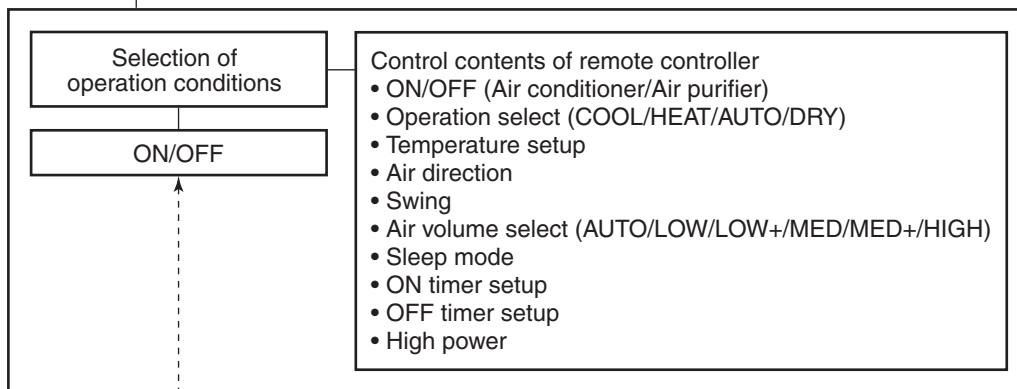

**Indoor unit**

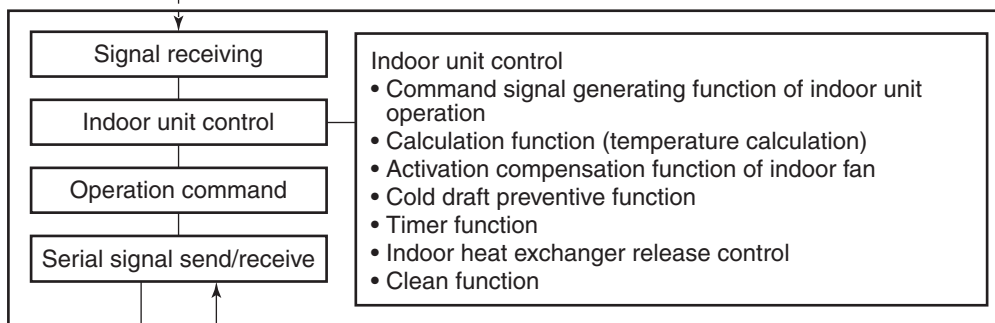

- Indoor fan motor
- Louver motor
- Moving panel motor
- Air purifier

**Outdoor unit**

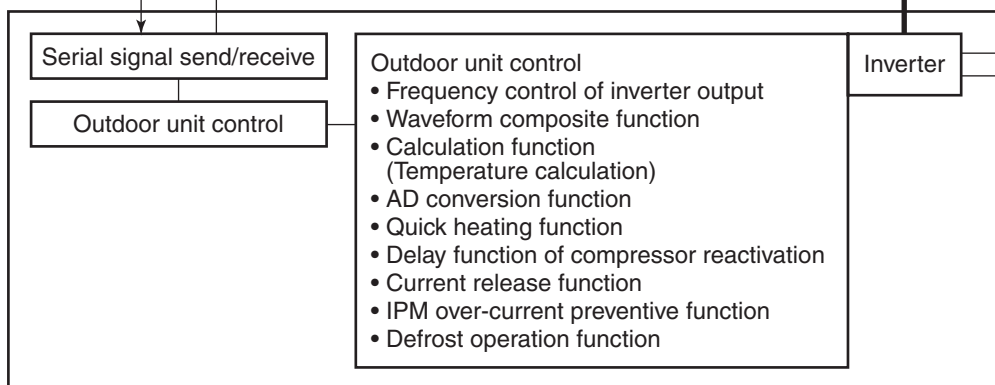

- Compressor
- Outdoor fan motor
- 4-way valve
- Pulse motor valve (P.M.V.)

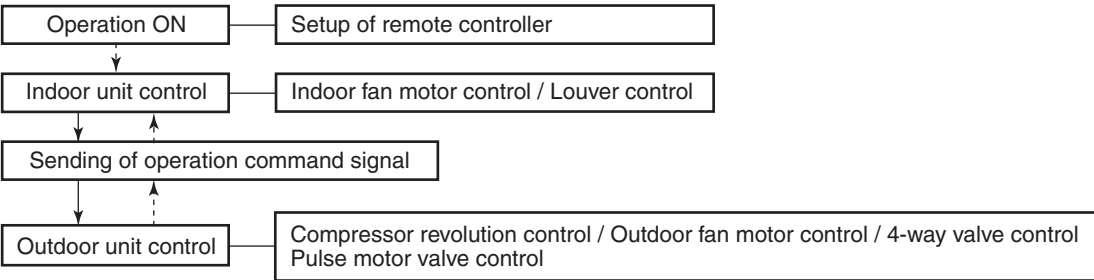
Item	Operation flow and applicable data, etc.	Description																																																																																																																																					
1. Basic operation	<p><b>2. Operating mode selection when performing 2-room operation</b></p> <p>1) The outdoor unit operating mode conforms to the instructions of the indoor unit that was pushed first.</p> <p>2) When combined operation consisting of cooling (dry) and heating, fan (air purification) and heating, or cleaning operation and heating is performed, operation conforms to the instructions of the indoor unit that was pushed first as shown in the following table.</p> <p>3) The indoor fan stops for the indoor unit that was pushed last and which instructions are ignored.</p> <p>4) When three or four indoor units are operated concurrently, the priority is also given to operating mode of the indoor unit which was pushed first as same as the case when two indoor units are operated concurrently.</p> <table border="1" data-bbox="331 504 1428 1413"> <thead> <tr> <th>No.</th> <th>Indoor unit</th> <th>Set operating mode</th> <th>Actual indoor unit operation</th> <th>Actual outdoor unit operation</th> </tr> </thead> <tbody> <tr> <td rowspan="2">1</td> <td>Pushed first</td> <td>Cooling (dry)</td> <td>Cooling (dry)</td> <td rowspan="2">Cooling</td> </tr> <tr> <td>Pushed last</td> <td>Cooling (dry)</td> <td>Cooling (dry)</td> </tr> <tr> <td rowspan="2">2</td> <td>Pushed first</td> <td>Heating</td> <td>Heating</td> <td rowspan="2">Heating</td> </tr> <tr> <td>Pushed last</td> <td>Heating</td> <td>Heating</td> </tr> <tr> <td rowspan="2">3</td> <td>Pushed first</td> <td>Fan (solo air purification)</td> <td>Fan (solo air purification)</td> <td rowspan="2">Stopped</td> </tr> <tr> <td>Pushed last</td> <td>Fan (solo air purification)</td> <td>Fan (solo air purification)</td> </tr> <tr> <td rowspan="2">4</td> <td>Pushed first</td> <td>Fan (solo air purification)</td> <td>Fan (solo air purification)</td> <td rowspan="2">Cooling</td> </tr> <tr> <td>Pushed last</td> <td>Cooling (dry)</td> <td>Cooling (dry)</td> </tr> <tr> <td rowspan="2">5</td> <td>Pushed first</td> <td>Cooling (dry)</td> <td>Cooling (dry)</td> <td rowspan="2">Cooling</td> </tr> <tr> <td>Pushed last</td> <td>Fan (solo air purification)</td> <td>Fan (solo air purification)</td> </tr> <tr> <td rowspan="2">6</td> <td>Pushed first</td> <td>Cooling (dry)</td> <td>Cooling (dry)</td> <td rowspan="2">Cooling</td> </tr> <tr> <td>Pushed last</td> <td>Heating</td> <td>Fan stopped</td> </tr> <tr> <td rowspan="2">7</td> <td>Pushed first</td> <td>Heating</td> <td>Heating</td> <td rowspan="2">Heating</td> </tr> <tr> <td>Pushed last</td> <td>Cooling (dry)</td> <td>Fan stopped</td> </tr> <tr> <td rowspan="2">8</td> <td>Pushed first</td> <td>Fan (solo air purification)</td> <td>Fan (solo air purification)</td> <td rowspan="2">Stopped</td> </tr> <tr> <td>Pushed last</td> <td>Heating</td> <td>Fan stopped</td> </tr> <tr> <td rowspan="2">9</td> <td>Pushed first</td> <td>Heating</td> <td>Heating</td> <td rowspan="2">Heating</td> </tr> <tr> <td>Pushed last</td> <td>Fan (solo air purification)</td> <td>Fan stopped</td> </tr> <tr> <td rowspan="2">10</td> <td>Pushed first</td> <td>Cleaning operation</td> <td>Cleaning operation</td> <td rowspan="2">Stopped</td> </tr> <tr> <td>Pushed last</td> <td>Cleaning operation</td> <td>Cleaning operation</td> </tr> <tr> <td rowspan="2">11</td> <td>Pushed first</td> <td>Cleaning operation</td> <td>Cleaning operation</td> <td rowspan="2">Cooling</td> </tr> <tr> <td>Pushed last</td> <td>Cooling (dry)</td> <td>Cooling (dry)</td> </tr> <tr> <td rowspan="2">12</td> <td>Pushed first</td> <td>Cooling (dry)</td> <td>Cooling (dry)</td> <td rowspan="2">Cooling</td> </tr> <tr> <td>Pushed last</td> <td>Cleaning operation</td> <td>Cleaning operation</td> </tr> <tr> <td rowspan="2">13</td> <td>Pushed first</td> <td>Cleaning operation</td> <td>Cleaning operation</td> <td rowspan="2">Stopped</td> </tr> <tr> <td>Pushed last</td> <td>Fan (solo air purification)</td> <td>Fan (solo air purification)</td> </tr> <tr> <td rowspan="2">14</td> <td>Pushed first</td> <td>Fan (solo air purification)</td> <td>Fan (solo air purification)</td> <td rowspan="2">Stopped</td> </tr> <tr> <td>Pushed last</td> <td>Cleaning operation</td> <td>Cleaning operation</td> </tr> <tr> <td rowspan="2">15</td> <td>Pushed first</td> <td>Cleaning operation</td> <td>Cleaning operation</td> <td rowspan="2">Stopped</td> </tr> <tr> <td>Pushed last</td> <td>Heating</td> <td>Fan stopped</td> </tr> <tr> <td rowspan="2">16</td> <td>Pushed first</td> <td>Heating</td> <td>Heating</td> <td rowspan="2">Heating</td> </tr> <tr> <td>Pushed last</td> <td>Cleaning operation</td> <td>Fan stopped</td> </tr> </tbody> </table>	No.	Indoor unit	Set operating mode	Actual indoor unit operation	Actual outdoor unit operation	1	Pushed first	Cooling (dry)	Cooling (dry)	Cooling	Pushed last	Cooling (dry)	Cooling (dry)	2	Pushed first	Heating	Heating	Heating	Pushed last	Heating	Heating	3	Pushed first	Fan (solo air purification)	Fan (solo air purification)	Stopped	Pushed last	Fan (solo air purification)	Fan (solo air purification)	4	Pushed first	Fan (solo air purification)	Fan (solo air purification)	Cooling	Pushed last	Cooling (dry)	Cooling (dry)	5	Pushed first	Cooling (dry)	Cooling (dry)	Cooling	Pushed last	Fan (solo air purification)	Fan (solo air purification)	6	Pushed first	Cooling (dry)	Cooling (dry)	Cooling	Pushed last	Heating	Fan stopped	7	Pushed first	Heating	Heating	Heating	Pushed last	Cooling (dry)	Fan stopped	8	Pushed first	Fan (solo air purification)	Fan (solo air purification)	Stopped	Pushed last	Heating	Fan stopped	9	Pushed first	Heating	Heating	Heating	Pushed last	Fan (solo air purification)	Fan stopped	10	Pushed first	Cleaning operation	Cleaning operation	Stopped	Pushed last	Cleaning operation	Cleaning operation	11	Pushed first	Cleaning operation	Cleaning operation	Cooling	Pushed last	Cooling (dry)	Cooling (dry)	12	Pushed first	Cooling (dry)	Cooling (dry)	Cooling	Pushed last	Cleaning operation	Cleaning operation	13	Pushed first	Cleaning operation	Cleaning operation	Stopped	Pushed last	Fan (solo air purification)	Fan (solo air purification)	14	Pushed first	Fan (solo air purification)	Fan (solo air purification)	Stopped	Pushed last	Cleaning operation	Cleaning operation	15	Pushed first	Cleaning operation	Cleaning operation	Stopped	Pushed last	Heating	Fan stopped	16	Pushed first	Heating	Heating	Heating	Pushed last	Cleaning operation	Fan stopped	
No.	Indoor unit	Set operating mode	Actual indoor unit operation	Actual outdoor unit operation																																																																																																																																			
1	Pushed first	Cooling (dry)	Cooling (dry)	Cooling																																																																																																																																			
	Pushed last	Cooling (dry)	Cooling (dry)																																																																																																																																				
2	Pushed first	Heating	Heating	Heating																																																																																																																																			
	Pushed last	Heating	Heating																																																																																																																																				
3	Pushed first	Fan (solo air purification)	Fan (solo air purification)	Stopped																																																																																																																																			
	Pushed last	Fan (solo air purification)	Fan (solo air purification)																																																																																																																																				
4	Pushed first	Fan (solo air purification)	Fan (solo air purification)	Cooling																																																																																																																																			
	Pushed last	Cooling (dry)	Cooling (dry)																																																																																																																																				
5	Pushed first	Cooling (dry)	Cooling (dry)	Cooling																																																																																																																																			
	Pushed last	Fan (solo air purification)	Fan (solo air purification)																																																																																																																																				
6	Pushed first	Cooling (dry)	Cooling (dry)	Cooling																																																																																																																																			
	Pushed last	Heating	Fan stopped																																																																																																																																				
7	Pushed first	Heating	Heating	Heating																																																																																																																																			
	Pushed last	Cooling (dry)	Fan stopped																																																																																																																																				
8	Pushed first	Fan (solo air purification)	Fan (solo air purification)	Stopped																																																																																																																																			
	Pushed last	Heating	Fan stopped																																																																																																																																				
9	Pushed first	Heating	Heating	Heating																																																																																																																																			
	Pushed last	Fan (solo air purification)	Fan stopped																																																																																																																																				
10	Pushed first	Cleaning operation	Cleaning operation	Stopped																																																																																																																																			
	Pushed last	Cleaning operation	Cleaning operation																																																																																																																																				
11	Pushed first	Cleaning operation	Cleaning operation	Cooling																																																																																																																																			
	Pushed last	Cooling (dry)	Cooling (dry)																																																																																																																																				
12	Pushed first	Cooling (dry)	Cooling (dry)	Cooling																																																																																																																																			
	Pushed last	Cleaning operation	Cleaning operation																																																																																																																																				
13	Pushed first	Cleaning operation	Cleaning operation	Stopped																																																																																																																																			
	Pushed last	Fan (solo air purification)	Fan (solo air purification)																																																																																																																																				
14	Pushed first	Fan (solo air purification)	Fan (solo air purification)	Stopped																																																																																																																																			
	Pushed last	Cleaning operation	Cleaning operation																																																																																																																																				
15	Pushed first	Cleaning operation	Cleaning operation	Stopped																																																																																																																																			
	Pushed last	Heating	Fan stopped																																																																																																																																				
16	Pushed first	Heating	Heating	Heating																																																																																																																																			
	Pushed last	Cleaning operation	Fan stopped																																																																																																																																				
	<p><b>3. Cooling/Heating operation</b></p> <p>The operations are performed in the following parts by controls according to cooling/heating conditions.</p> <p>1) Receiving the operation ON signal of the remote controller, the cooling or heating operation signal starts being transferred from the indoor controller to the outdoor unit.</p> <p>2) At the indoor unit side, the indoor fan is operated according to the contents of “<b>2. Indoor fan motor control</b>” and the louver according to the contents of “<b>10. Louver control</b>”, respectively.</p> <p>3) The outdoor unit controls the outdoor fan motor, compressor, pulse motor valve (PMV) and 4-way valve according to the operation signal sent from the indoor unit.</p> <p>*1. The relay of 4-way valve is turned on, for a few seconds when 4-way valve is driven.</p>  <pre> graph TD     A[Operation ON] --&gt; B[Indoor unit control]     C[Setup of remote controller] --- A     B --&gt; D[Sending of operation command signal]     D --&gt; E[Outdoor unit control]     E --&gt; B     F[Indoor fan motor control / Louver control] --- B     G[Compressor revolution control / Outdoor fan motor control / 4-way valve control / Pulse motor valve control] --- E     </pre>																																																																																																																																						

Item	Operation flow and applicable data, etc.	Description																																																							
2. Outdoor fan motor control	<p>The blowing air volume at the outdoor unit side is controlled.                      Receiving the operation command from the controller of indoor unit, the controller of outdoor unit controls fan speed.                      * For the fan motor, a DC motor with non-stage variable speed system is used.                      However, it is limited to 8 stages for reasons of controlling.</p>	<p>1) The operation command sent from the remote controller is processed by the indoor unit controller and transferred to the controller of the outdoor unit.                      2) When strong wind blows at outdoor side, the operation of air conditioner continues with the fan motor stopped.                      3) Whether the fan is locked or not is detected, and the operation of air conditioner stops and an alarm is displayed if the fan is locked.                      4) According to each operation mode, by the conditions of outdoor temperature (To) and compressor revolution, the speed of the outdoor fan shown in the table is selected.</p>																																																							
<b>Cooling operation, dry operation</b>																																																									
<table border="1" style="width: 100%; border-collapse: collapse;"> <thead> <tr> <th colspan="2" style="text-align: left;">Compressor revolution (rps)</th> <th style="text-align: center;">~16.8</th> <th style="text-align: center;">~41.3</th> <th style="text-align: center;">~51.5</th> <th style="text-align: center;">52.1~</th> </tr> </thead> <tbody> <tr> <td rowspan="8" style="vertical-align: middle;">Outdoor temp. sensor To</td> <td rowspan="6" style="vertical-align: middle;">Normal operation</td> <td style="text-align: right;">To ≥ 38°C</td> <td style="text-align: center;">390</td> <td style="text-align: center;">650</td> <td style="text-align: center;">800</td> <td style="text-align: center;">800</td> </tr> <tr> <td style="text-align: right;">28 ≤ To &lt; 38°C</td> <td style="text-align: center;">390</td> <td style="text-align: center;">650</td> <td style="text-align: center;">650</td> <td style="text-align: center;">800</td> </tr> <tr> <td style="text-align: right;">15 ≤ To &lt; 28°C</td> <td style="text-align: center;">300</td> <td style="text-align: center;">650</td> <td style="text-align: center;">650</td> <td style="text-align: center;">650</td> </tr> <tr> <td style="text-align: right;">10 ≤ To &lt; 15°C</td> <td style="text-align: center;">300</td> <td style="text-align: center;">650</td> <td style="text-align: center;">650</td> <td style="text-align: center;">650</td> </tr> <tr> <td style="text-align: right;">5 ≤ To &lt; 10°C</td> <td style="text-align: center;">390</td> <td style="text-align: center;">390</td> <td style="text-align: center;">390</td> <td style="text-align: center;">650</td> </tr> <tr> <td style="text-align: right;">0 ≤ To &lt; 5°C</td> <td style="text-align: center;">390</td> <td style="text-align: center;">300</td> <td style="text-align: center;">300</td> <td style="text-align: center;">390</td> </tr> <tr> <td rowspan="2" style="vertical-align: middle;">Sleep operation</td> <td style="text-align: right;">To ≥ 38°C</td> <td style="text-align: center;">390</td> <td style="text-align: center;">650</td> <td style="text-align: center;">650</td> <td style="text-align: center;">800</td> </tr> <tr> <td style="text-align: right;">To &lt; 38°C</td> <td style="text-align: center;">390</td> <td style="text-align: center;">650</td> <td style="text-align: center;">650</td> <td style="text-align: center;">650</td> </tr> <tr> <td colspan="2" style="text-align: left;">To is abnormal</td> <td style="text-align: center;">390</td> <td style="text-align: center;">650</td> <td style="text-align: center;">650</td> <td style="text-align: center;">800</td> </tr> </tbody> </table> <p style="text-align: right; margin-right: 50px;">To : Outdoor temp sensor</p>			Compressor revolution (rps)		~16.8	~41.3	~51.5	52.1~	Outdoor temp. sensor To	Normal operation	To ≥ 38°C	390	650	800	800	28 ≤ To < 38°C	390	650	650	800	15 ≤ To < 28°C	300	650	650	650	10 ≤ To < 15°C	300	650	650	650	5 ≤ To < 10°C	390	390	390	650	0 ≤ To < 5°C	390	300	300	390	Sleep operation	To ≥ 38°C	390	650	650	800	To < 38°C	390	650	650	650	To is abnormal		390	650	650	800
Compressor revolution (rps)		~16.8	~41.3	~51.5	52.1~																																																				
Outdoor temp. sensor To	Normal operation	To ≥ 38°C	390	650	800	800																																																			
		28 ≤ To < 38°C	390	650	650	800																																																			
		15 ≤ To < 28°C	300	650	650	650																																																			
		10 ≤ To < 15°C	300	650	650	650																																																			
		5 ≤ To < 10°C	390	390	390	650																																																			
		0 ≤ To < 5°C	390	300	300	390																																																			
	Sleep operation	To ≥ 38°C	390	650	650	800																																																			
		To < 38°C	390	650	650	650																																																			
To is abnormal		390	650	650	800																																																				
<b>Heating operation</b>																																																									
<table border="1" style="width: 100%; border-collapse: collapse;"> <thead> <tr> <th colspan="2" style="text-align: left;">Compressor revolution (rps)</th> <th style="text-align: center;">~16.8</th> <th style="text-align: center;">~27.5</th> <th style="text-align: center;">28.1~</th> </tr> </thead> <tbody> <tr> <td rowspan="8" style="vertical-align: middle;">Outdoor temp. sensor To</td> <td rowspan="4" style="vertical-align: middle;">Normal operation</td> <td style="text-align: right;">To ≥ 10°C</td> <td style="text-align: center;">390</td> <td style="text-align: center;">650</td> <td style="text-align: center;">650</td> </tr> <tr> <td style="text-align: right;">0 ≤ To &lt; 10°C</td> <td style="text-align: center;">500</td> <td style="text-align: center;">650</td> <td style="text-align: center;">830</td> </tr> <tr> <td style="text-align: right;">-5 ≤ To &lt; 0°C</td> <td style="text-align: center;">650</td> <td style="text-align: center;">830</td> <td style="text-align: center;">850</td> </tr> <tr> <td style="text-align: right;">To &lt; -5°C</td> <td style="text-align: center;">650</td> <td style="text-align: center;">830</td> <td style="text-align: center;">850</td> </tr> <tr> <td rowspan="4" style="vertical-align: middle;">Sleep operation</td> <td style="text-align: right;">To ≥ 10°C</td> <td style="text-align: center;">390</td> <td style="text-align: center;">500</td> <td style="text-align: center;">650</td> </tr> <tr> <td style="text-align: right;">0 ≤ To &lt; 10°C</td> <td style="text-align: center;">390</td> <td style="text-align: center;">650</td> <td style="text-align: center;">650</td> </tr> <tr> <td style="text-align: right;">-5 ≤ To &lt; 0°C</td> <td style="text-align: center;">390</td> <td style="text-align: center;">650</td> <td style="text-align: center;">650</td> </tr> <tr> <td style="text-align: right;">To &lt; -5°C</td> <td style="text-align: center;">390</td> <td style="text-align: center;">650</td> <td style="text-align: center;">650</td> </tr> <tr> <td colspan="2" style="text-align: left;">To is abnormal</td> <td style="text-align: center;">390</td> <td style="text-align: center;">650</td> <td style="text-align: center;">830</td> </tr> </tbody> </table> <p style="text-align: right; margin-right: 50px;">To : Outdoor temp sensor</p>			Compressor revolution (rps)		~16.8	~27.5	28.1~	Outdoor temp. sensor To	Normal operation	To ≥ 10°C	390	650	650	0 ≤ To < 10°C	500	650	830	-5 ≤ To < 0°C	650	830	850	To < -5°C	650	830	850	Sleep operation	To ≥ 10°C	390	500	650	0 ≤ To < 10°C	390	650	650	-5 ≤ To < 0°C	390	650	650	To < -5°C	390	650	650	To is abnormal		390	650	830										
Compressor revolution (rps)		~16.8	~27.5	28.1~																																																					
Outdoor temp. sensor To	Normal operation	To ≥ 10°C	390	650	650																																																				
		0 ≤ To < 10°C	500	650	830																																																				
		-5 ≤ To < 0°C	650	830	850																																																				
		To < -5°C	650	830	850																																																				
	Sleep operation	To ≥ 10°C	390	500	650																																																				
		0 ≤ To < 10°C	390	650	650																																																				
		-5 ≤ To < 0°C	390	650	650																																																				
		To < -5°C	390	650	650																																																				
To is abnormal		390	650	830																																																					

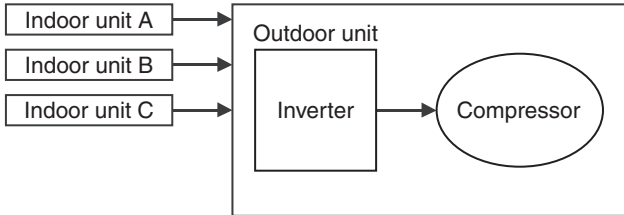
Item	Operation flow and applicable data, etc.	Description
3. Capacity control	<p>1) The indoor units from A to C determine the respective instruction revolutions from the difference between the remote controller setting temperature (Ts) and the indoor temperature (Ta), and transmit this to the outdoor unit.</p> <p>2) The outdoor unit receives the instructions from the indoor units, and the inverter operates the compressor at the calculated revolutions.</p> <p>3) The compressor operation range in each operating mode is shown in the left table.</p> 	

Operation mode	No. of operating unit	Combination of indoor units	Compressor revolution (rps)	Operation mode	No. of operating unit	Combination of indoor units	Compressor revolution (rps)
COOL	1 unit	M07	12 to 22.1	HEAT	1 unit	M07	12 to 42.5
		M10	12 to 22.1			M10	12 to 42.5
		M13	12 to 34.1			M13	12 to 51.5
		M16	12 to 43.1			M16	12 to 54.4
		M18	12 to 44.9			M18	12 to 69.4
		M22	12 to 56.2			M22	12 to 73.6
		M24	12 to 80.2			M24	12 to 100.5
	2 units	○ *	12 to 53.3		2 units	○ *	12 to 73.6
	3 units	○ *	24.5 to 56.2		3 units	○ *	14.4 to 73.6

\* : In case that any multiple indoor units are combined.

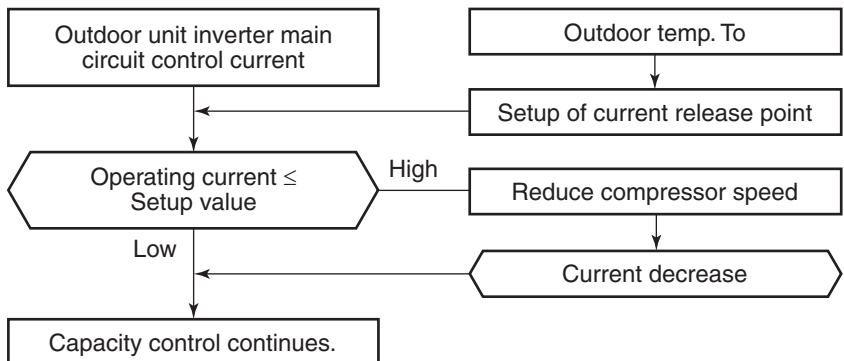
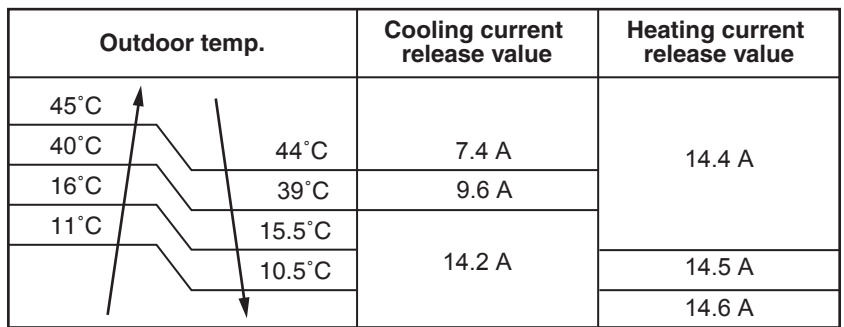
4. Current release control	<p>This function prevents troubles on the electronic parts of the compressor driving inverter.</p> <p>This function also controls drive circuit of the compressor speed so that electric power of the compressor drive circuit does not exceed the specified value.</p> 	<p>1) The input current of the outdoor unit is detected in the inverter section of the outdoor unit.</p> <p>2) According to the detected outdoor temperature, the specified value of the current is selected.</p> <p>3) Whether the current value exceeds the specified value or not is judged.</p> <p>4) If the current value exceeds the specified value, this function reduces the compressor speed and controls speed up to the closest one commanded from the indoor unit within the range which does not exceed the specified value.</p>														
	<table border="1"> <thead> <tr> <th>Outdoor temp.</th> <th>Cooling current release value</th> <th>Heating current release value</th> </tr> </thead> <tbody> <tr> <td>45°C</td> <td rowspan="2">7.4 A</td> <td rowspan="2">14.4 A</td> </tr> <tr> <td>40°C</td> </tr> <tr> <td>16°C</td> <td>9.6 A</td> <td rowspan="3">14.5 A</td> </tr> <tr> <td>11°C</td> <td rowspan="2">14.2 A</td> </tr> <tr> <td>10.5°C</td> <td>14.6 A</td> </tr> </tbody> </table> 	Outdoor temp.	Cooling current release value	Heating current release value	45°C	7.4 A	14.4 A	40°C	16°C	9.6 A	14.5 A	11°C	14.2 A	10.5°C	14.6 A	
Outdoor temp.	Cooling current release value	Heating current release value														
45°C	7.4 A	14.4 A														
40°C																
16°C	9.6 A	14.5 A														
11°C	14.2 A															
10.5°C			14.6 A													

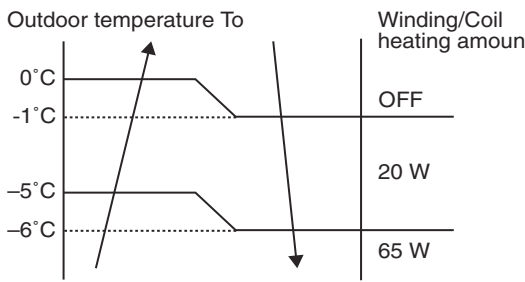
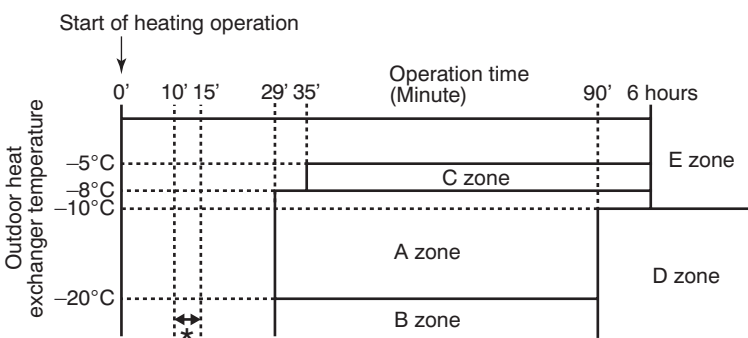
Item	Operation flow and applicable data, etc.	Description												
<p>5. Winding/Coil heating control</p>	<p>When the outdoor temperature is low, the windings/coils are heated to ensure compressor reliability.</p> 	<p>Winding/Coil heating is performed when the following conditions are met.</p> <p><b>Condition 1 :</b> When the discharge sensor temperature (Td) is less than 30°C.</p> <p><b>Condition 2 :</b> When the outdoor sensor temperature (To) is as shown in the left figure.</p>												
<p>6. Defrost control (Only in heating operation)</p>	<p>(This function removes frost adhered to the outdoor heat exchanger.)</p> <p>The temperature sensor of the outdoor heat exchanger (Te sensor) judges the frosting status of the outdoor heat exchanger and the defrost operation is performed with 4-way valve reverse defrost system.</p>  <p>* The minimum value of Te sensor 10 to 15 minutes after start of operation is stored in memory as Te0 and Te1. (-10°C &lt; Te1 ≤ 10°C)</p> <p style="text-align: center;"><b>Table 1</b></p> <table border="1" data-bbox="167 1377 933 1724"> <thead> <tr> <th>Zone</th> <th>Defrost operation start condition</th> </tr> </thead> <tbody> <tr> <td><b>A zone</b></td> <td>When <math>Te_0 - TE \geq 2.5</math> continued for 2 minutes in A zone, defrost operation starts.</td> </tr> <tr> <td><b>B zone</b></td> <td>When the operation continued for 2 minutes in B zone, defrost operation starts.</td> </tr> <tr> <td><b>C zone</b></td> <td>When <math>Te_0 - TE \geq 3</math> continued for 2 minutes in C zone, defrost operation starts.</td> </tr> <tr> <td><b>D zone</b></td> <td>When the operation continued for 2 minutes in D zone, defrost operation starts.</td> </tr> <tr> <td><b>E zone</b></td> <td>When <math>Te_1 - TE \geq 1</math> continued for 2 minutes in E zone, defrost operation starts.</td> </tr> </tbody> </table>	Zone	Defrost operation start condition	<b>A zone</b>	When $Te_0 - TE \geq 2.5$ continued for 2 minutes in A zone, defrost operation starts.	<b>B zone</b>	When the operation continued for 2 minutes in B zone, defrost operation starts.	<b>C zone</b>	When $Te_0 - TE \geq 3$ continued for 2 minutes in C zone, defrost operation starts.	<b>D zone</b>	When the operation continued for 2 minutes in D zone, defrost operation starts.	<b>E zone</b>	When $Te_1 - TE \geq 1$ continued for 2 minutes in E zone, defrost operation starts.	<p>The necessity of defrost operation is detected by the outdoor heat exchanger temperature. The conditions to detect the necessity of defrost operation differ in A, B, C, D or E zone each. (Table 1)</p> <p><b>&lt;Defrost operation&gt;</b></p> <ul style="list-style-type: none"> <li>Defrost operation in A to E zones</li> </ul> <ol style="list-style-type: none"> <li>Stop operation of the compressor for 30 seconds.</li> <li>Invert (OFF) 4-way valve 10 seconds after stop of the compressor.</li> <li>The outdoor fan stops at the same time when the compressor stops.</li> <li>When temperature of the indoor heat exchanger becomes 38°C or lower, stop the indoor fan.</li> </ol> <p><b>&lt;Finish of defrost operation&gt;</b></p> <ul style="list-style-type: none"> <li>Returning conditions from defrost operation to heating operation</li> </ul> <ol style="list-style-type: none"> <li>Temperature of outdoor heat exchanger rises to +8°C or higher.</li> <li>Temperature of outdoor heat exchanger is kept at +5°C or higher for 80 seconds.</li> <li>Defrost operation continues for 10 minutes.</li> </ol> <p><b>&lt;Returning from defrost operation&gt;</b></p> <ol style="list-style-type: none"> <li>Stop operation of the compressor for approx. 60 seconds.</li> <li>Invert (ON) 4-way valve approx. 40 seconds after stop of the compressor.</li> <li>The outdoor fan starts rotating at the same time when the compressor starts.</li> </ol>
Zone	Defrost operation start condition													
<b>A zone</b>	When $Te_0 - TE \geq 2.5$ continued for 2 minutes in A zone, defrost operation starts.													
<b>B zone</b>	When the operation continued for 2 minutes in B zone, defrost operation starts.													
<b>C zone</b>	When $Te_0 - TE \geq 3$ continued for 2 minutes in C zone, defrost operation starts.													
<b>D zone</b>	When the operation continued for 2 minutes in D zone, defrost operation starts.													
<b>E zone</b>	When $Te_1 - TE \geq 1$ continued for 2 minutes in E zone, defrost operation starts.													
<p>7. Compressor protective control</p>	<ol style="list-style-type: none"> <li>This control purposes to raise the operation frequency until 36Hz for 2 minutes in order to protect the compressor (Prevention of oil accumulation in the refrigerating cycle) when the status that the operation frequency is 36Hz or less has continued for 10 hours was calculated.</li> </ol> <p>The operation frequency follows the normal indoor command after controlling.</p> <ol style="list-style-type: none"> <li>Although the compressor may stop by THERMO-OFF control when the room temperature varies and then attains the set temperature by this control, it is not abnormal.</li> <li>During this control works, it stopping the operation by the remote controller, the operation does not continue.</li> </ol>													

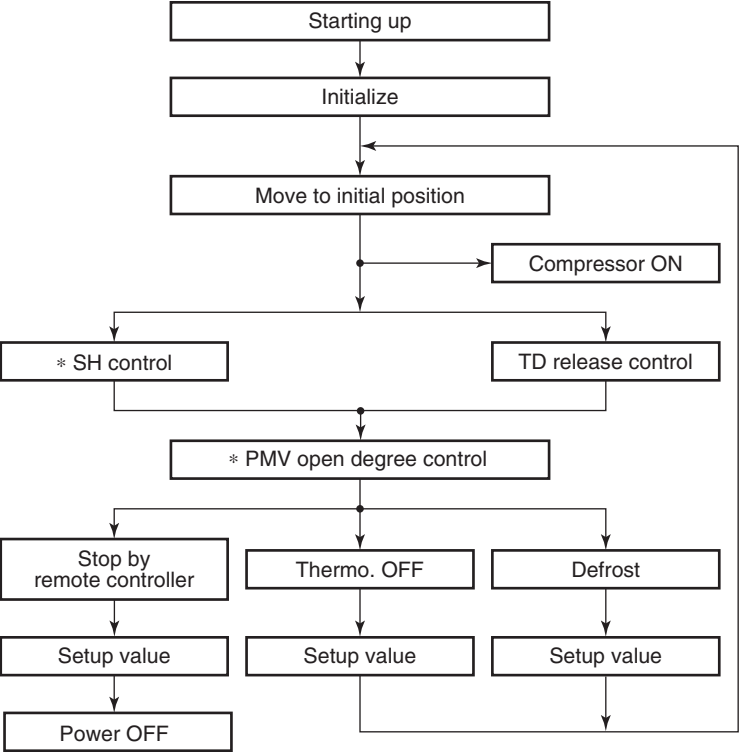

Item	Operation flow and applicable data, etc.	Description														
<p>8. Discharge temperature control</p> <table border="1" data-bbox="172 331 914 667"> <thead> <tr> <th>Td value</th> <th>Control operation</th> </tr> </thead> <tbody> <tr> <td>120°C</td> <td>Judges as an error and stops the compressor.</td> </tr> <tr> <td>115°C</td> <td>Reduce the compressor speed.</td> </tr> <tr> <td>111°C</td> <td>Reduce slowly compressor speed.</td> </tr> <tr> <td>108°C</td> <td>Keeps the compressor speed.</td> </tr> <tr> <td>101°C</td> <td>If the operation is performed with lower speed than one commanded by the serial signal, speed is slowly raised up to the commanded speed.</td> </tr> <tr> <td></td> <td>Operates with speed commanded by the serial signal.</td> </tr> </tbody> </table>	Td value	Control operation	120°C	Judges as an error and stops the compressor.	115°C	Reduce the compressor speed.	111°C	Reduce slowly compressor speed.	108°C	Keeps the compressor speed.	101°C	If the operation is performed with lower speed than one commanded by the serial signal, speed is slowly raised up to the commanded speed.		Operates with speed commanded by the serial signal.		<p><b>1. Purpose</b> This function detects error on the refrigerating cycle or error on the compressor, and performs protective control.</p> <p><b>2. Operation</b></p> <ul style="list-style-type: none"> <li>Control of the compressor speed The speed control is performed as described in the left table based upon the discharge temperature.</li> </ul>
Td value	Control operation															
120°C	Judges as an error and stops the compressor.															
115°C	Reduce the compressor speed.															
111°C	Reduce slowly compressor speed.															
108°C	Keeps the compressor speed.															
101°C	If the operation is performed with lower speed than one commanded by the serial signal, speed is slowly raised up to the commanded speed.															
	Operates with speed commanded by the serial signal.															
<p>9. Pulse motor valve (PMV) control</p>  <p>* SH (Super Heat amount) = Ts (Temperature of suction pipe of the compressor) – Tc or Te (Heat exchanger temperature at evaporation side)</p> <p>* PMV: Pulse Motor Valve</p>	<p>This function controls throttle amount of the refrigerant in the refrigerating cycle. According to operating status of the air conditioner, this function also controls the open degree of valve with an expansion valve with pulse motor.</p>	<ol style="list-style-type: none"> <li>When starting the operation, move the valve once until it fits to the stopper. (Initialize) * In this time, "Click" sound may be heard.</li> <li>Adjust the open degree of valve by super heat amount. (SH control)</li> <li>If the discharge temperature was excessively up, adjust the open degree of valve so that it is in the range of set temperature. (Discharge temp. control)</li> <li>When defrost operation is performed, the open degree of PMV is adjusted according to each setup conditions during preparation for defrost and during defrost operation (4-way valve is inverted.).</li> <li>When turning off the compressor by thermo. OFF or STOP by remote controller, the open degree of the PMV is adjusted to the setup value.</li> </ol>														
<p>10. High-pressure switch/ Compressor case thermostat control</p>	<ol style="list-style-type: none"> <li>When the high-pressure switch or the compressor case thermostat operates, the operation of the compressor is terminated.</li> <li>The compressor restarts after 2 minutes 30 seconds using [1] as an error count. After restart, the error count is cleared when operation continues for 10 minutes or more.</li> <li>An error is confirmed with the error count [10].</li> <li>For the indicated contents of error, confirm using the check code table.</li> </ol>															

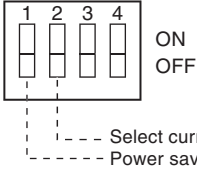
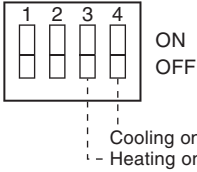
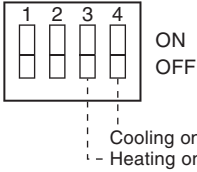
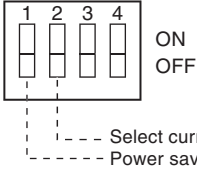
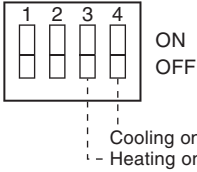
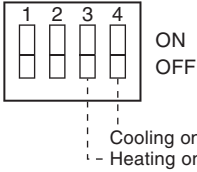
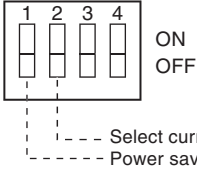
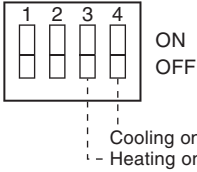
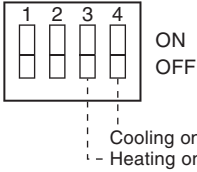
Item	Operation flow and applicable data, etc.	Description																											
11. Various setting on outdoor unit (Power save, Cooling-only, etc.)	<p style="text-align: center;"><b>The following settings are available by DIP switch setup.</b></p> <table border="1" style="width: 100%;"> <thead> <tr> <th data-bbox="411 293 549 331">Function</th> <th data-bbox="549 293 852 331">Setting position</th> <th data-bbox="852 293 1414 331">Control contents</th> </tr> </thead> <tbody> <tr> <td data-bbox="411 342 549 584">Power save setup</td> <td data-bbox="549 342 852 584"> <p style="text-align: center;">SW802</p>  </td> <td data-bbox="852 342 1414 584"> <p>Turn the switch to ON, when using the power save function.</p> <p>SW802</p> <table border="1" style="width: 100%;"> <tr> <td>No.1</td> <td>ON</td> <td>ON</td> <td>OFF</td> <td>OFF</td> </tr> <tr> <td>No.2</td> <td>OFF</td> <td>ON</td> <td>ON</td> <td>OFF</td> </tr> <tr> <td>Current limit</td> <td>11A</td> <td>8.5A</td> <td>Full</td> <td>Full (Default)</td> </tr> </table> </td> </tr> <tr> <td data-bbox="411 595 549 719">Cooling-only setup</td> <td data-bbox="549 595 852 719"> <p style="text-align: center;">SW801</p>  </td> <td data-bbox="852 595 1414 719"> <p>When using the air conditioner as a cooling-only conditioner, turn the switch to ON. (If the heating mode is selected by remote control, outdoor unit will remain stop. If mixed with indoor unit cooling and heating, outdoor unit performs cooling operation.)</p> </td> </tr> <tr> <td data-bbox="411 730 549 842">Heating-only setup</td> <td data-bbox="549 730 852 842"> <p style="text-align: center;">SW801</p>  </td> <td data-bbox="852 730 1414 842"> <p>When using the air conditioner as a heating-only conditioner, turn the switch to ON. (If the cooling mode is selected by remote control, outdoor unit will remain stop. If mixed with indoor unit cooling and heating, outdoor unit performs heating operation.)</p> </td> </tr> </tbody> </table> <p>Caution: Set the switch before turning on the power supply.</p>	Function	Setting position	Control contents	Power save setup	<p style="text-align: center;">SW802</p> 	<p>Turn the switch to ON, when using the power save function.</p> <p>SW802</p> <table border="1" style="width: 100%;"> <tr> <td>No.1</td> <td>ON</td> <td>ON</td> <td>OFF</td> <td>OFF</td> </tr> <tr> <td>No.2</td> <td>OFF</td> <td>ON</td> <td>ON</td> <td>OFF</td> </tr> <tr> <td>Current limit</td> <td>11A</td> <td>8.5A</td> <td>Full</td> <td>Full (Default)</td> </tr> </table>	No.1	ON	ON	OFF	OFF	No.2	OFF	ON	ON	OFF	Current limit	11A	8.5A	Full	Full (Default)	Cooling-only setup	<p style="text-align: center;">SW801</p> 	<p>When using the air conditioner as a cooling-only conditioner, turn the switch to ON. (If the heating mode is selected by remote control, outdoor unit will remain stop. If mixed with indoor unit cooling and heating, outdoor unit performs cooling operation.)</p>	Heating-only setup	<p style="text-align: center;">SW801</p> 	<p>When using the air conditioner as a heating-only conditioner, turn the switch to ON. (If the cooling mode is selected by remote control, outdoor unit will remain stop. If mixed with indoor unit cooling and heating, outdoor unit performs heating operation.)</p>	
Function	Setting position	Control contents																											
Power save setup	<p style="text-align: center;">SW802</p> 	<p>Turn the switch to ON, when using the power save function.</p> <p>SW802</p> <table border="1" style="width: 100%;"> <tr> <td>No.1</td> <td>ON</td> <td>ON</td> <td>OFF</td> <td>OFF</td> </tr> <tr> <td>No.2</td> <td>OFF</td> <td>ON</td> <td>ON</td> <td>OFF</td> </tr> <tr> <td>Current limit</td> <td>11A</td> <td>8.5A</td> <td>Full</td> <td>Full (Default)</td> </tr> </table>	No.1	ON	ON	OFF	OFF	No.2	OFF	ON	ON	OFF	Current limit	11A	8.5A	Full	Full (Default)												
No.1	ON	ON	OFF	OFF																									
No.2	OFF	ON	ON	OFF																									
Current limit	11A	8.5A	Full	Full (Default)																									
Cooling-only setup	<p style="text-align: center;">SW801</p> 	<p>When using the air conditioner as a cooling-only conditioner, turn the switch to ON. (If the heating mode is selected by remote control, outdoor unit will remain stop. If mixed with indoor unit cooling and heating, outdoor unit performs cooling operation.)</p>																											
Heating-only setup	<p style="text-align: center;">SW801</p> 	<p>When using the air conditioner as a heating-only conditioner, turn the switch to ON. (If the cooling mode is selected by remote control, outdoor unit will remain stop. If mixed with indoor unit cooling and heating, outdoor unit performs heating operation.)</p>																											

### 9-3. Intermittent Operation Control for Indoor Fans of the Indoor Unit at Thermo-off Side in Heating Operation

While heating operation is executed in two rooms, if room temperature reached the setup temperature in one room and thermo-off occurred, the following operations start. (Refer to the figure below.)

1. The indoor unit of the room (A room) in which thermo-off did not occur starts a continuous operation with the setup number of revolution.
2. The indoor unit of the room (B room) in which thermo-off occurred starts intermittent operation of the indoor fan. The indoor fan operates with number of revolution of UL or SUL. Fan-ON time is 2 minutes and Fan-OFF time is 2 to 4 minutes.

However if temperature of the indoor heat exchanger becomes over 55°C or more in B room, the indoor fan stops the intermittent operation and starts continuous operation.

While heating operation is executed in 2 rooms, if room temperature reached the setup temperature in both rooms and thermo-off occurred, both indoor units start intermittent operation of the indoor fan.

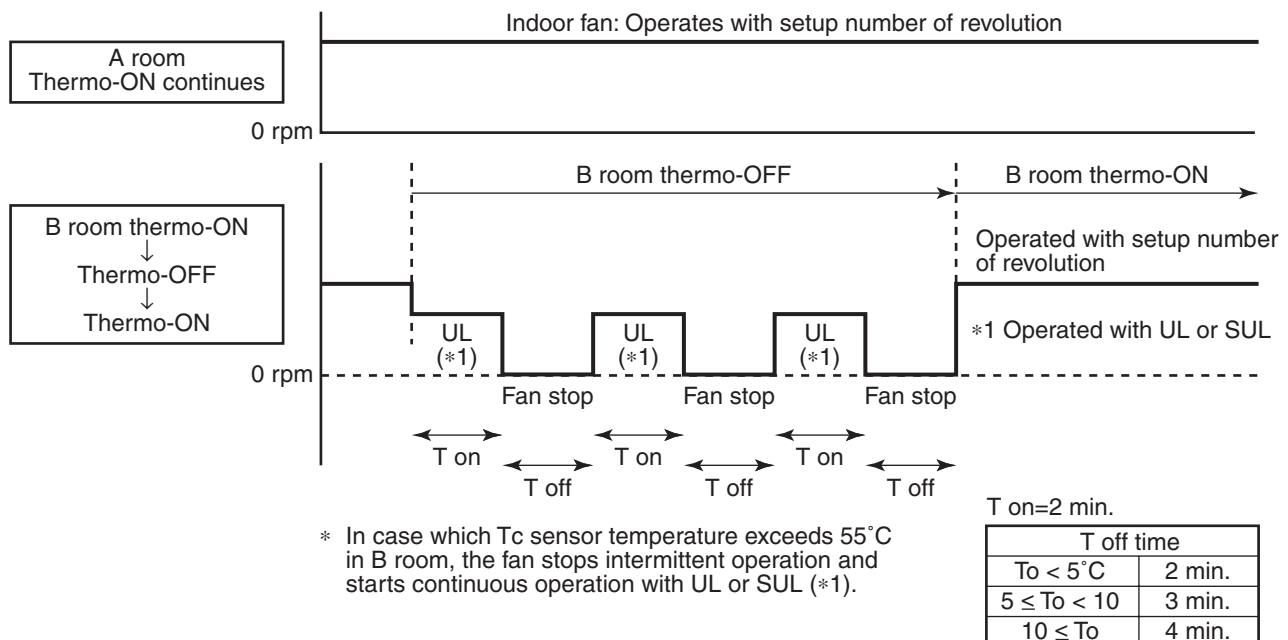

## 10. INSTALLATION PROCEDURE







### 10-1. Installation/Service Tools

#### Changes in the product and components

In the case of an air conditioner using R410A, in order to prevent any other refrigerant from being charged accidentally, the service port diameter of the outdoor unit control valve (3-way valve) has been changed. (1/2 UNF 20 threads per inch)

- In order to increase the pressure resisting strength of the refrigerant piping flare processing diameter and size of opposite side of flare nuts has been changed. (for copper pipes with nominal dimensions 1/2 and 5/8)

#### New tools for R410A

New tools for R410A	Applicable to R22 model		Changes
Gauge manifold	×		As pressure is high, it is impossible to measure by means of conventional gauge. In order to prevent any other refrigerant from being charged, each port diameter has been changed.
Charge hose	×		In order to increase pressure resisting strength, hose materials and port size have been changed (to 1/2 UNF 20 threads per inch). When purchasing a charge hose, be sure to confirm the port size.
Electronic balance for refrigerant charging	○		As pressure is high and gasification speed is fast, it is difficult to read the indicated value by means of charging cylinder, as air bubbles occur.
Torque wrench (nominal diam. 1/2, 5/8)	×		The size of opposite sides of flare nuts have been increased. Incidentally, a common wrench is used for nominal diameters 1/4 and 3/8.
Flare tool (clutch type)	○		By increasing the clamp bar's receiving hole, strength of spring in the tool has been improved.
Gauge for projection adjustment	—	—	Used when flare is made by using conventional flare tool.
Vacuum pump adapter	○		Connected to conventional vacuum pump. It is necessary to use an adapter to prevent vacuum pump oil from flowing back to the charge hose. The charge hose connecting part has two ports-one for conventional refrigerant (7/16 UNF 20 threads per inch) and one for R410A. If the vacuum pump oil (mineral) mixes with R410A a sludge may occur and damage the equipment.
Gas leakage detector	×		Exclusive for HFC refrigerant.





- Incidentally, the “refrigerant cylinder” comes with the refrigerant designation (R410A) and protector coating in the U. S's ARI specified rose color (ARI color code: PMS 507).
- Also, the “charge port and packing for refrigerant cylinder” require 1/2 UNF 20 threads per inch corresponding to the charge hose's port size.

### CAUTION

- Incorrect wiring connection may cause electrical parts to burn out.
- Be sure to comply with local regulations/codes when running the wire from outdoor unit to indoor unit. (Size of wire and wiring method etc.)
- Every wire must be securely connected.
- If incorrect or incomplete wiring is carried out, fire or smoke may result.
- Prepare the power supply for the exclusive use of the air conditioner.

## 10-2. Outdoor Unit

### 10-2-1. Accessory and Installation Parts

Installation manual	1		Rubber cap (Water-proof)	5		CD-ROM (Installation manual) *1	1	
F-GAS label *1	1		Drain nipple	1				

\*1 Part that do not exist in RAS-3M26S3AV-A,-TR.

### 10-2-2. Refrigerant Piping

- Piping kit used for the conventional refrigerant cannot be used.
- **Use copper pipe with 0.8 mm or more thickness.**
- Flare nut and flare works are also different from those of the conventional refrigerant. Take out the flare nut attached to the main unit of the air conditioner, and use it.

### 10-2-3. Installation Place

- A place which provides the spaces around the outdoor unit.
- A place where the operation noise and discharged air do not disturb your neighbors.
- A place which is not exposed to a strong wind.
- A place which does not block a passageway.
- When the outdoor unit is to be installed in an elevated position, be sure to secure its feet.
- There must be sufficient spaces for carrying the unit into and out of the site.
- A place where the drain water does not raise any problem.
- A place which can bear the weight of the outdoor unit and does not allow an increase in noise level and vibration.

### CAUTION

1. Install the outdoor unit without anything blocking the air discharging.
2. When the outdoor unit is installed in a place exposed always to a strong wind like a coast or on a high story of a building, secure the normal fan operation using a duct or a wind shield.
3. Especially in windy area, install the unit to prevent the admission of wind.

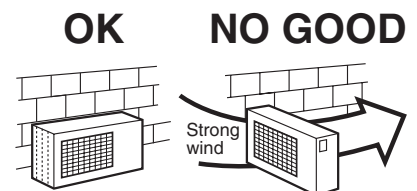

Fig. 10-2-1

4. Installation in the following places may result in trouble. Do not install the unit in such places.
  - A place full of machine oil.
  - A place full of sulfide gas.
  - A place where high-frequency waves are likely to be generated as from audio equipment, welders, and medical equipment.
  - A saline-place such as a coast.

### 10-2-4. Optional Installation Parts (Local Supply)

Parts name	Parts name			Q'ty
	Indoor unit (abbreviation)	Liquid side (O.D.)	Gas side (O.D.)	
Refrigerant piping *1	07, 10, 13	6.35 mm	9.52 mm	1 ea.
	16, 18, 22, 24	6.35 mm	12.7 mm	
Putty, PVC tapes				1 ea.

\*1 Refrigerant piping covered with insulating material (Polyethylene form, 6 mm thick).

When duct-type or cassette-type unit is to be installed, it shall be covered with thicker insulating material (Polyethylene form, 10 mm thick).

**10-2-5. Installation**

**NOTE**

For installation, at least 3 dimensions should be kept free from obstacles (walls).

**Necessary space for installation**

If you need to install the outdoor unit in a location where there are some obstructions or a wall, secure sufficient space as shown in the figure below.

The cooling/heating effect may be reduced by 10%.

**Upper side view (Unit: mm)**

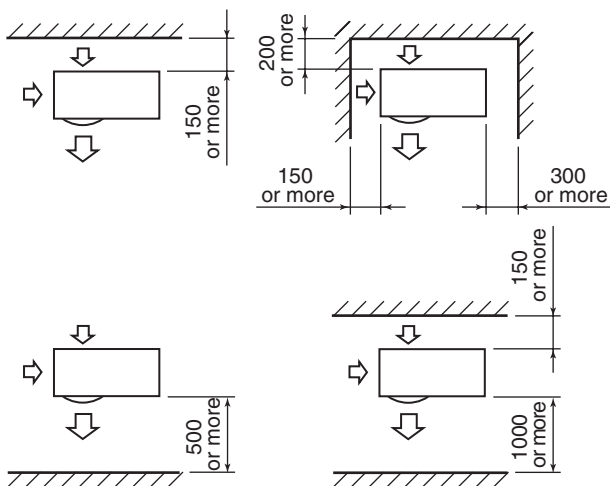

**Fig. 10-2-2**

**Side view (Unit: mm)**

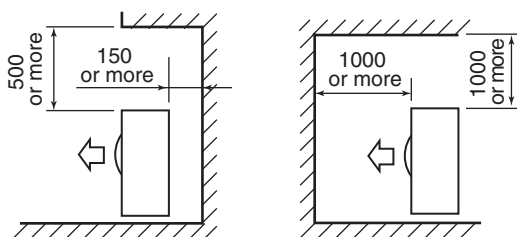

**Fig. 10-2-3**

**Fixing bolt arrangement of outdoor unit**

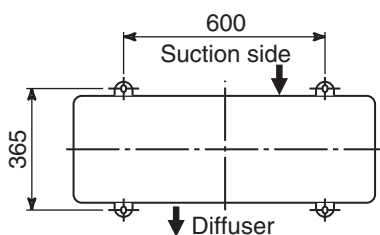
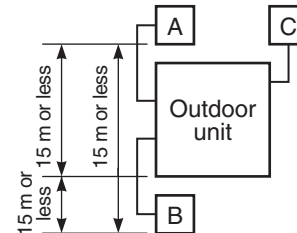

**Fig. 10-2-4**

- Secure the outdoor unit with the fixing bolts and nuts if the unit is likely to be exposed to a strong wind.
- Use Ø8 mm or Ø10 mm anchor bolts and nuts.

1. Piping connections to the outdoor unit should be arranged in the sequence A, B, C starting from the bottom.  
(For each piping connection, the gas pipe is on the bottom and the liquid pipe is on the top.)
2. When multiple indoor units are to be connected to the outdoor unit, make the ends of the pipes and wires from each indoor unit to ensure that they will be connected to the outdoor unit correctly.  
(Problems caused by indoor units being connected to the outdoor unit incorrectly are very common in multiple-unit installations.)
3. The length and height difference of the connecting pipes between the indoor and outdoor units must be within the ranges indicated below.

- Total piping length :  
Non. Additional refrigerant ..... 40 m  
Additional refrigerant ..... 70 m  
..... 41 to 70 m  
Additional 20 g of refrigerant..... Per every 1 m
- Minimum piping length :  
A or B or C = 3 m or more
- Maximum indoor piping length :  
A or B or C = 25 m or less
- Maximum piping height difference :  
A or B or C = 15 m or less
- Maximum piping/height difference between 2 units = 15 m or less



**Fig. 10-2-5**

4. Connect 2 or more indoor units for heat pump.
5. If the outdoor units is to be mounted on a wall, make sure that the platform supporting it is sufficiently strong.

The platform should be designed and manufactured to maintain its strength over a long period of time, and sufficient consideration should be given to ensuring that the outdoor unit will not fall.

6. When the outdoor unit is to be mounted high on a wall, take particular care to ensure that parts do not fall installer is protected.
7. When doing installation work on level ground, it is usual to wiring and piping connections to the indoor units. And/then make to the outdoor unit. However if outdoor work is difficult it is possible instead to make changes to the procedure.

For example by making adjustments to the wiring and piping length on the inside (rather than the outside).

◆ **How to remove the front panel**

1. Remove 5 screws of the front panel.
2. Pull the front panel downward.

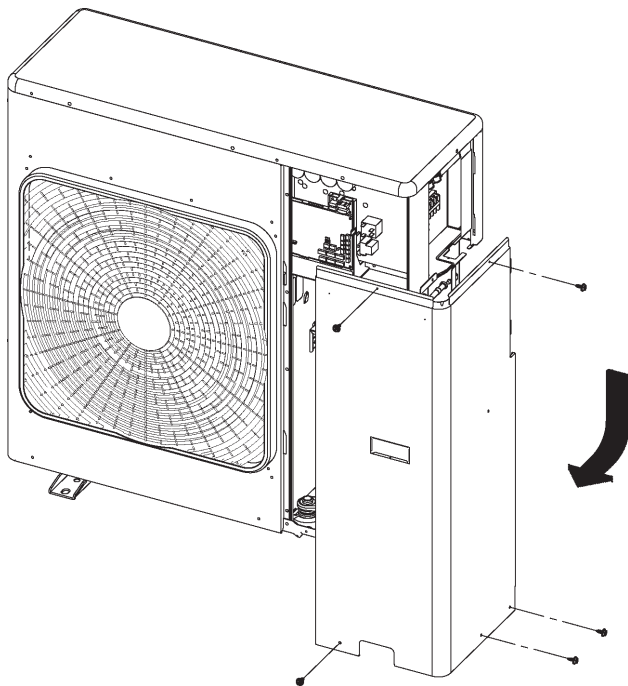

Fig. 10-2-6

◆ **Tightening connection**

Align the centers of the connecting pipes and tighten the flare nut as far as possible with your fingers.

Then tighten the nut with a spanner and torque wrench as shown in the figure.



**CAUTION**

- Do not apply excess torque. Otherwise, the nut may break.

(Unit : N·m)

Outer dia. of copper pipe	Tightening torque
Ø6.35 mm	14 to 18 (1.4 to 1.8 kgf·m)
Ø9.52 mm	33 to 42 (3.3 to 4.2 kgf·m)
Ø12.7 mm	50 to 62 (5.0 to 6.2 kgf·m)

• **Tightening torque of flare pipe**

The pressure of R410A is higher than R22. (Approx. 1.6 times)

Therefore securely tighten the flare pipes which connect the outdoor unit and indoor unit with the specified tightening torque using a torque wrench.

If any flare pipe is incorrectly connected, it may cause not only a gas leakage but also trouble in the refrigeration cycle.

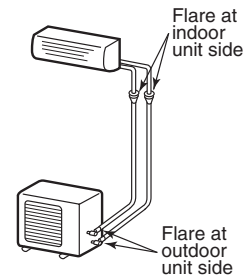

Fig. 10-2-7

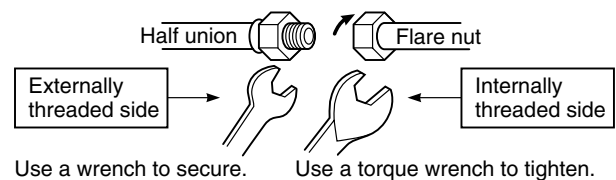

Fig. 10-2-8

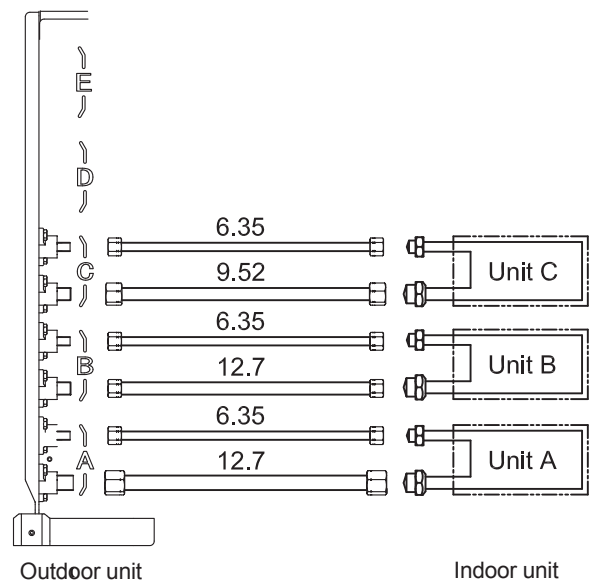

Fig. 10-2-9

Connectable capacity class			Total
A	B	C	
07, 10, 13 (with reducer)		16 (with expander)	54
16, 18, 22, 24		07, 10, 13	

### 10-2-6. Refrigerant Piping Connection



#### KEEP IMPORTANT 4 POINTS FOR PIPING WORK

1. Keep dust and moisture from entering the pipes.
2. Tight connection (between pipes and unit)
3. Evacuate the air in the connecting pipes using VACUUM PUMP.
4. Check gas leak. (connected points)

#### ◆ Flaring

1. Cut the pipe with a pipe cutter.

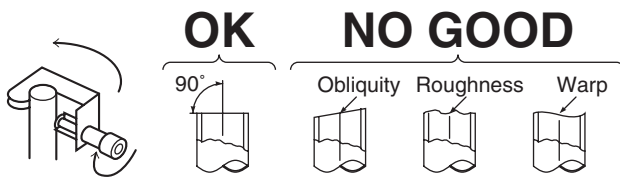

Fig. 10-2-10

2. Insert a flare nut into the pipe, and flare the pipe. As the flaring sizes of R410A differ from those of refrigerant R22, the flare tools newly manufactured for R410A are recommended. However, the conventional tools can be used by adjusting projection margin of the copper pipe.

#### • Projection margin in flaring : B (Unit : mm)

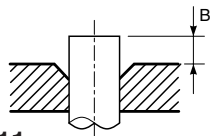

Fig. 10-2-11

Rigid (Clutch type)

Outer dia. of copper pipe	R410A tool used		Conventional tool used	
	R410A	R22	R410A	R22
6.35	0 to 0.5	(Same as left)	1.0 to 1.5	0.5 to 1.0
9.52	0 to 0.5	(Same as left)	1.0 to 1.5	0.5 to 1.0
12.7	0 to 0.5	(Same as left)	1.0 to 1.5	0.5 to 1.0

Imperial (Wing nut type)

Outer dia. of copper pipe	R410A	R22
6.35	1.5 to 2.0	1.0 to 1.5
9.52	1.5 to 2.0	1.0 to 1.5
12.7	2.0 to 2.5	1.5 to 2.0

#### • Flaring size : A (Unit : mm)

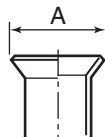

Fig. 10-2-12

Outer dia. of copper pipe	A $\pm 0.4$	
	R410A	R22
6.35	9.1	9.0
9.52	13.2	13.0
12.7	16.6	16.2

\* In the case of flaring for R410A with the conventional flare tool, pull out it approx. 0.5 mm more than that for R22 to adjust to the specified flare size. The copper pipe gauge is useful for adjusting projection margin size.

### 10-2-7. Evacuating

After the piping has been connected to all indoor unit(s), you can perform the air purge together at once.

#### AIR PURGE

Evacuate the air in the connecting pipes and in the indoor unit using vacuum pump.

Do not use the refrigerant in the outdoor unit. For details, see the manual of vacuum pump.

#### ◆ Use a vacuum pump

Be sure to use a vacuum pump with counter-flow prevention function so that inside oil of the pump does not flow backward into pipes of the air conditioner when the pump stops. (If inside oil of the vacuum pump enters into the air conditioner which adopts R410A, a trouble of the refrigeration cycle may be caused.)

1. Connect the charge hose from the manifold valve to the service port of the gas side packed valve.
2. Connect the charge hose to the port of vacuum pump.
3. Open fully the low pressure side handle of the gauge manifold valve.
4. Operate the vacuum pump to start for evacuating. Perform evacuating for about 40 minutes if the piping length is total 70 meters. (assuming a pump capacity of 27 liters per minute.) Then confirm that the compound pressure gauge reading is  $-101 \text{ kPa}$  ( $-76 \text{ cmHg}$ ).
5. Close the low pressure side valve handle of gauge manifold.
6. Open fully the valve stem of the packed valves (both sides of Gas and Liquid).
7. Remove the charging hose from the service port.
8. Securely tighten the caps on the packed valves.

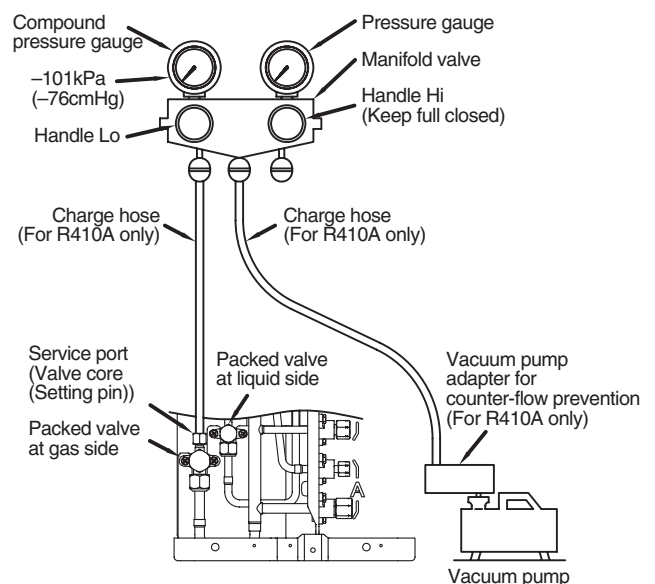

Fig. 10-2-13



**◆ Packed valve handling precautions**

- Open the valve stem all the way out ; do not try to open it beyond the stopper.
- Securely tighten the valve stem cap in torque is as follows :

Gas side (Ø12.7 mm)	50 to 62 N•m (5.0 to 6.2 kgf•m)
Gas side (Ø9.52 mm)	33 to 42 N•m (3.3 to 4.2 kgf•m)
Liquid side (Ø6.35 mm)	14 to 18 N•m (1.4 to 1.8 kgf•m)
Service port	14 to 18 N•m (1.4 to 1.8 kgf•m)

Hexagonal wrench is required.

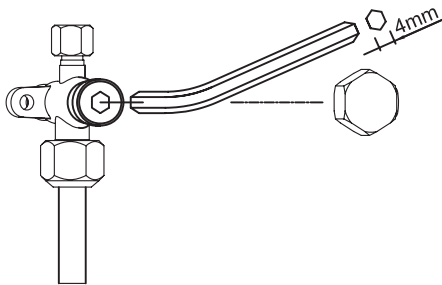

Fig. 10-2-14

**10-2-8. Electrical Work**

For the air conditioner that has no power cord, connect a power cord to it as mentioned below.

Model	3 Units Multi
	3M26S3AV-E,-A,-TR
Power supply	220 – 240 V, ~50 Hz 220 V, ~60 Hz
Maximum running current	15.4 A
Installation fuse rating	20 A breaker or fuse (All types can be used.)
Power cord	H07 RN-F or 245 IEC 66 (2.5 mm <sup>2</sup> or more)

**◆ Wiring connection**

1. Remove the front panel and cord clamp from the outdoor unit.
2. Connect the connecting cable to the terminal as identified by the matching numbers on the terminal block of indoor and outdoor unit.
3. Insert the power cord and the connecting cable fully into the terminal block and secure it tightly with screws.
4. Insulate the unused cords (conductors) from water entering in the outdoor unit. Locate them so that they do not touch any electrical or metal parts.
5. Secure the power cord and the connecting cable with the cord clamp.
6. Attach the front panel on the outdoor unit.

**3 units (A + B + C) Multi**

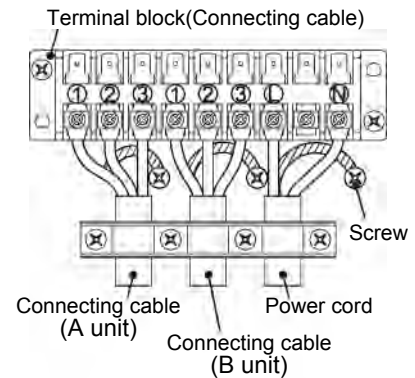

Fig. 10-4-15

**3 units (A + B + C) Multi**

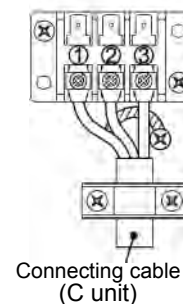

Fig. 10-4-16

**⚠ CAUTION**

- Wrong wiring connection may cause some electrical parts burn out.
- Be sure to use the cord clamps specified positions with attached to the product.
- Do not damage or scratch the conductive core and inner insulator of power and inter-connecting cables when peeling them.
- Be sure to comply with local codes on running the wire from outdoor unit to indoor unit (size of wire and wiring method etc.)
- Use the power cord and Inter-connecting cable with specified thickness, specified type, and protective devices specified.

**◆ Stripping length power cord and connecting cable**

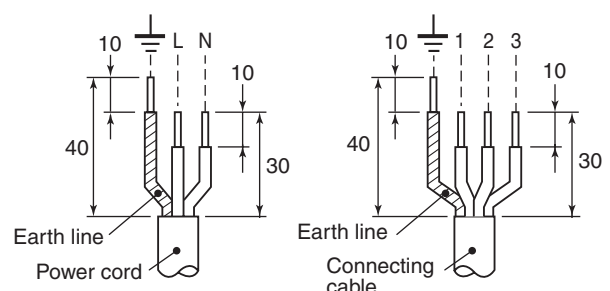

Fig. 10-2-17



### 10-2-8. Check and Test Operation

For R410A, use the leak detector exclusively manufactured for HFC refrigerant (R410A, R134a, etc.).

- \* The conventional leak detector for HCFC refrigerant (R22, etc.) cannot be used because its sensitivity for HFC refrigerant lowers to approx. 1/40.
- Pressure of R410A becomes approx. 1.6 times of that of R22. If installation work is incompletely finished, a gas leakage may occur in the cases such as pressure rise during operation. Therefore, be sure to test the piping connections for leaking.

Check places for indoor unit

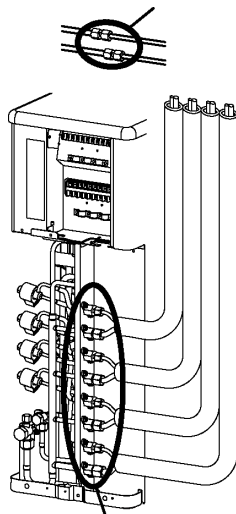

Check places for outdoor unit

Fig. 10-2-18

- Check the flare nut connections, valve stem cap connections and service port cap connections for gas leak with a leak detector or soap water.

### CAUTION

- Use a circuit breaker of a type that is not tripped by shock waves.
- If incorrect/incomplete wiring is carried out, it will cause an electrical fire or smoke.
- Prepare the power supply for exclusive use with the air conditioner.
- This product can be connected to the mains.

Connection to fixed wiring :

A switch or circuit breaker which disconnects all poles and has a contact separation of at least 3 mm must be incorporate in the fixed wiring. An approved short circuit breaker or switches must be used.

- \* (A breaker having a sensitivity of approximately 0.1 second or less and a capacity of approximately 30 mA is usually used.)

### 10-2-9. Miswiring (Mispiping) Check

Make sure that the wiring and piping for each room have the same alphabetical codes (A, B, C).

Connect and secure the power cord.

Use the power cord/cables with thickness, type and protective devices specified in this manual.

Insulate the unused cords (conductors) with PVC tape.

1. Detach the front panel of the outdoor unit.  
Do not remove the air discharge grille.
2. Turn on the circuit breaker to supply electricity.
3. Start running all the indoor units connected to the outside unit in the cooling mode.
  - You need not specify the temperature setting of the indoor units.
  - You cannot check wiring/piping when the external temperature is 5°C or less.
4. Turn on the SW802 No.4 switch on the P.C. board MCC 5071.

The wiring / piping check starts automatically.

While checking, each LED flashes consecutively to indicate that the checking each indoor unit is in progress. When checking is complete, the check result is displayed on the LED panel.

See the table below for details.

- 4-1. If no problems are detected.

The checking operation returns to the normal operation automatically.

The compressor stops temporarily, then it restarts. The D801 LED flashes while the compressor is stopped.

- 4-2. If incorrect wiring/piping is detected.

The checking operation stops.

Check the status of the LED to confirm the details of the problem. Turn off the circuit breaker, then check wiring/piping again.

5. Turn off SW802 No.4 switch on the P.C. board MCC 5071.

- The checking operation changes to the normal operation.

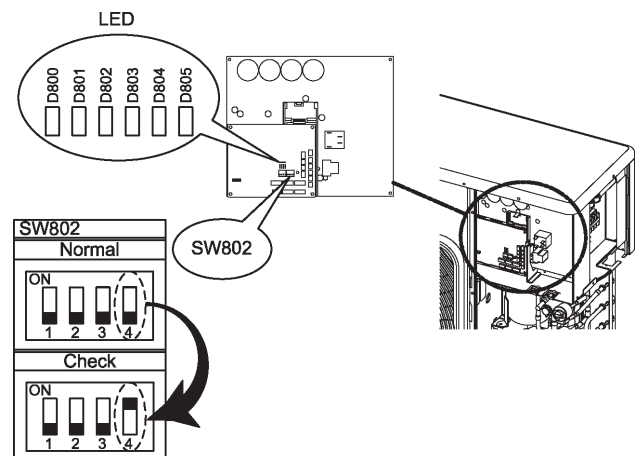

Fig. 10-2-19

☒ : LED ON, ● : LED OFF, ◎ : LED Flash

	LED						Description
	D800	D801	D802	D803	D804	D805	
Before check	☒	●	●	●	●	●	Normal operation (no error)
During check	◎	◎	●	●	●	●	Checking A unit
	◎	●	◎	●	●	●	Checking B unit
	◎	●	●	◎	●	●	Checking C unit
Check results	☒	●	●	●	●	●	Normal operation (no error)
	◎	☒	●	●	●	●	Trouble in unit A
	◎	●	☒	●	●	●	Trouble in unit B
	◎	●	●	☒	●	●	Trouble in unit C
	◎	☒	☒	●	●	●	Trouble in unit A and B
	◎	☒	●	☒	●	●	Trouble in unit A and C
	◎	☒	●	●	●	☒	Trouble in unit A
	◎	●	☒	☒	●	●	Trouble in unit B and C
	◎	●	☒	●	●	☒	Trouble in unit B
	◎	●	●	☒	●	☒	Trouble in unit C
	◎	☒	☒	☒	●	●	Trouble in unit A,B and C
	◎	☒	☒	●	●	☒	Trouble in unit A,B
	◎	☒	●	☒	●	☒	Trouble in unit A,C
	◎	●	☒	☒	●	☒	Trouble in unit B,C
	◎	☒	☒	☒	●	☒	Trouble in unit A,B,C
◎	☒	☒	☒	☒	☒	Trouble in all units service valve stays closed	

### 10-3. Test Operation

#### 10-3-1. Gas Leak Test

Check the flare nut connections for gas leaks with a gas leak detector and/or soapy water.

Check places for indoor unit

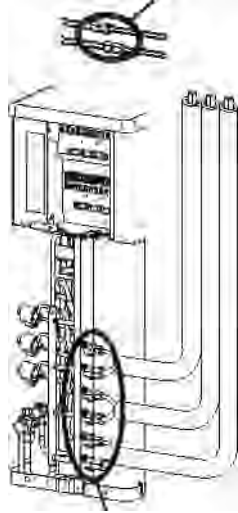

Check places for outdoor unit

Fig. 10-3-1

#### 10-3-2. Test Operation

To switch the TEST RUN (COOL) mode, press RESET button for 10 sec.  
(The beeper will make a short beep.)

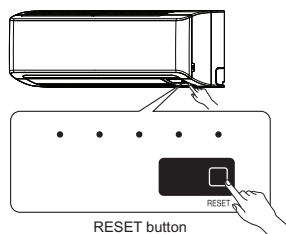

Fig. 10-3-2

#### 10-3-3. Setting the Auto Restart

This product is designed so that, after a power failure, it can restart automatically in the same operating mode as before the power failure.

#### NOTE

The product was shipped with Auto Restart function in the OFF position. Turn it ON as required.

- 1) Push and hold the RESET button for about 3 seconds. After 3 seconds, three short electric beeps will be heard to inform you that the Auto Restart has been selected.
- 2) To cancel the Auto Restart, follow the steps described in the section Auto Restart Function of the Owner's Manual.

#### 10-3-4. Remote Control A-B Selection

- When two indoor units are installed in the same room or adjacent two rooms, if operating a unit, two units may receive the remote control signal simultaneously and operate. In this case, the operation can be preserved by setting either one remote control to B setting. (Both are set to A setting in factory shipment.)
- The remote control signal is not received when the settings of indoor unit and remote control are different.
- There is no relation between A setting/B setting and A room/B room when connecting the piping and cables.

##### <Remote control A-B selection>

To separate using of remote control for each indoor unit in case of 2 air conditioners are installed nearby.

##### <Remote Control B Setup>

1. Press [RESET] button on the indoor unit to turn the air conditioner ON.
2. Point the remote control at the indoor unit
3. Push and hold [CHECK] button on the Remote Control by the tip of the pencil. "00" will be shown on the display (Picture ①)
4. Press [MODE] during pushing [CHECK]. "B" will show on the display and "00" will disappear and the air conditioner will turn OFF. The Remote Control B is memorized (Picture ②).

- NOTE :**
1. Repeat above step to reset Remote Control to be A.
  2. Remote Control A has not "A" display
  3. Default setting of Remote Control for factory is A.

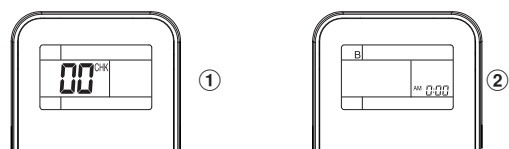

Fig. 10-3-3

## 11. HOW TO DIAGNOSE THE TROUBLE

The pulse modulating circuits are mounted to both indoor and outdoor units.

Therefore, diagnose troubles according to the trouble diagnosis procedure as described below.

(Refer to the check points in servicing written on the wiring diagrams attached to the indoor/outdoor units.)

Table 11-1

No.	Troubleshooting Procedure	Page
1	First Confirmation	61
2	Primary Judgment	62
3	Judgment by Flashing LED of Indoor Unit	62
4	Self-Diagnosis by Remote Controller (Check Code)	63
5	Judgment of Trouble by Symptom	70
6	Trouble Diagnosis by Outdoor LED	72
7	Troubleshooting	80
8	Inspection of the Main Parts	82
9	How to Simply Judge Whether Outdoor Fan Motor is Good or Bad	83

### NOTE

A large-capacity electrolytic capacitor is used in the outdoor unit controller (inverter). Therefore, if the power supply is turned off, charge (charging voltage DC280V to 373V) remains and discharging takes a lot of time (for more than 5 minutes). After turning off the power source, if touching the charging section before discharging, an electrical shock may be caused.

Discharge the electrolytic capacitor completely by using solder iron, etc.

### WARNING

The electrolytic capacitor may not normally discharge according to error contents and the voltage may remain. Therefore, be sure to discharge the capacitor.

### WARNING

For discharging, never use a screwdriver and others for short-circuiting between + and – electrodes, As the electrolytic capacitor is one with a large capacity, it is very dangerous because a large electric spark will occur.

### <Discharging method>

Connect the discharge resistance (approx. 100Ω/40W) or plug of the soldering iron to voltage between + and – of C13 on the main P.C. board MCC-1571, and then perform discharging.



Fig. 11-1

**11-1. First Confirmation****11-1-1. Confirmation of Power Supply**

Confirm that the power breaker operates (ON) normally.

**11-1-2. Confirmation of Power Voltage**

Confirm that power voltage is AC 220–240  $\pm$ 10%.

If power voltage is not in this range, the unit may not operate normally.

**11-1-3. Operation Which is not a Trouble (Program Operation)**

For controlling the air conditioner, the program operations are built in the microcomputer as described in the following table.

If a claim is made for running operation, check whether or not it meets to the contents in the following table.

When it does, we inform you that it is not trouble of equipment, but it is indispensable for controlling and maintaining of air conditioner.

**Table 11-1-1**

No.	Operation of air conditioner	Description
1	When power breaker is turned "ON", the operation lamp (Green) of the indoor unit flashes.	The OPERATION lamp of the indoor unit flashes when power source is turned on. If "START/STOP" button is operated once, flashing stops. (Flashes also in power failure)
2	Compressor may not operate even if the room temperature is within range of compressor-ON.	The compressor does not operate while compressor restart delay timer (3-minutes timer) operates. The same phenomenon is found after power source has been turned on because 3-minutes timer operates.
3	In DRY and SLEEP MODE, FAN (air flow) display does not change even though FAN (air flow select) button is operated.	The air flow indication is fixed to [AUTO].
4	Increasing of compressor motor speed stops approx. 30 seconds after operation started, and then compressor motor speed increases again approx. 30 seconds after.	For smooth operation of the compressor, the compressor motor speed is restricted to Max. 33 rps for 2 minutes and Max. 57 rps for 2 minutes to 4 minutes, respectively after the operation has started.
5	The set value of the remote control should be below the room temperature.	If the set value is above the room temperature, Cooling operation is not performed. And check whether battery of the remote control is consumed or not.
6	In AUTO mode, the operation mode is changed.	After selecting Cool or Heat mode, select an operation mode again if the compressor keeps stop status for 15 minutes.
7	In HEAT mode, the compressor motor speed does not increase up to the maximum speed or decreases before the temperature arrives at the set temperature.	The compressor motor speed may decrease by high-temp. release control (Release protective operation by temp.-up of the indoor heat exchanger) or current release control.
8	Cool, Dry, or Heat operation cannot be performed.	When the unit in other room operates previously in different mode, Fan Only operation is performed because of first-push priority control. (Cool operation and Dry operation can be concurrently performed.)



## 11-2. Primary Judgment

To diagnose the troubles, use the following methods.

- 1) Judgment by flashing LED of indoor unit
- 2) Self-diagnosis by service check remote controller
- 3) Judgment of trouble by every symptom

Firstly use the method (1) for diagnosis. Then, use the method (2) or (3) to diagnose the details of troubles.

For any trouble occurred at the outdoor unit side, detailed diagnosis is possible by 6-serial LED on the control P.C. board.

## 11-3. Judgment by Flashing LED of Indoor Unit

While the indoor unit monitors the operation status of the air conditioner, if the protective circuit operates, the contents of self-diagnosis are displayed with block on the indoor unit indication section.

Table 11-3-1

	Item	Check code	Block display	Description for self-diagnosis
<div style="border: 1px solid black; padding: 5px; width: fit-content; margin-bottom: 5px;">Indoor indication lamp flashes.</div> <div style="text-align: center;">↓</div> <div style="border: 1px solid black; padding: 5px; width: fit-content; margin-bottom: 5px;">Which lamp does flash?</div> <div style="text-align: center;">↓</div> <div style="text-align: center;">→</div>	<b>A</b>	—	OPERATION (Green) Flashing display (1 Hz)	Power failure (when power is ON)
	<b>B</b>	00	OPERATION (Green) Flashing display (5 Hz)	Protective circuit operation for indoor P.C. board
	<b>C</b>	01	OPERATION (Green) TIMER (Orange) Flashing display (5 Hz)	Protective circuit operation for connecting cable and serial signal system
	<b>D</b>	02	OPERATION (Green) Flashing display (5 Hz)	Protective circuit operation for outdoor P.C. board
	<b>E</b>	03	OPERATION (Green) TIMER (Orange) Flashing display (5 Hz)	Protective circuit operation for others (including compressor)

### NOTE

- The contents of items B and C and a part of item E are displayed when air conditioner operates.
- When item B and C, and item B and a part of item E occur concurrently, priority is given to the block of item B.
- The check codes can be confirmed on the remote controller for servicing.

### 11-4. Self-Diagnosis by Remote Controller (Check Code)

1. If the lamps are indicated as shown B to E in Table 11-3-1, execute the self-diagnosis by the remote controller.
2. When the remote controller is set to the service mode, the indoor controller diagnoses the operation condition and indicates the information of the self-diagnosis on the display of the remote controller with the check codes.

If a fault is detected, all lamps on the indoor unit will flash at 5Hz and it will beep for 10 seconds (beep, beep, beep ...). The timer lamp usually flashes (5Hz) during self-diagnosis.

#### 11-4-1. How to Use Remote Controller in Service Mode

**1** Push [CHECK] button with a tip of pencil to set the remote controller to the service mode.

- “00” is indicated on the display of the remote controller.

**2** Push [ON ▲] or [OFF ▼] button

If there is no fault with a code, the indoor unit will beep once (Beep) and the display of the remote controller will change as follows :

00 → 01 → 02 ... 1d → 1E → 33

- The TIMER indicator of the indoor unit flashes continuously. (5 times per 1 sec.)
- Check the unit with all 52 check codes ( 00 to 33 ) as shown in Table-11-4-1.
- Press [ON ▲] or [OFF ▼] button to change the check code backward.

If there is a fault, the indoor unit will beep for 10 seconds (Beep, Beep, Beep ...).

Note the check code on the display of the remote controller.

- 2-digits alphanumeric will be indicated on the display.
- All indicators on the indoor unit will flash. (5 times per 1 sec.)

**3** Push [START/STOP] button to release the service mode.

- The display of the remote controller returns to as it was before service mode was engaged.

**4** Time shortening method.

1. Push SET button while pushing CHECK button.
2. Push [START/STOP] button.

Alphanumeric characters are used for the check codes.

5 is 5.	6 is 6.
A is A.	b is B.
C is C.	d is D.

Fig. 11-4-1

**11-4-2 Caution at Servicing**

1. After using the service mode of remote controller finished, press the [ ⏻ ] button to reset the remote controller to normal function.
2. After finished the diagnosis by the remote controller, turn OFF power supply and turn its ON again to reset the air conditioner to normal operation. However, the check codes are not deleted from memory of the microcomputer.
3. After servicing finished, press [ CLR ] button of remote controller under service mode status to send code "7F" to the indoor unit. The check code stored in memory is cleared.

Table 11-4-2

Block distinction		Operation of diagnosis function				Action and Judgment
Check code	Block	Check code	Cause of operation	Air conditioner status	Display flashing error	
00	Indoor P.C. board.	01	TA sensor ; The room temperature sensor is short-Circuit or disconnection.	Operation continues.	Flashes when error is detected.	1. Check the sensor TA and connection. 2. In case of the sensor and its connection is normal, check the P.C. board.
		02	TC sensor ; The heat exchanger temperature sensor of the indoor unit is out of place, disconnection, short-circuit or migration.	Operation continues.	Flashes when error is detected.	1. Check the sensor TC and connection. 2. In case of the sensor and its connection is normal, check the P.C. board.
		11	Fan motor of the indoor unit is failure, lock-rotor, short-circuit, disconnection, etc. Or its circuit on P.C. board has problem.	All OFF	Flashes when error is detected.	1. Check the fan motor and connection. 2. In case of the motor and its connection is normal, check the P.C. board.
		12	Other trouble on the indoor P.C. board.	Depend on cause of failure.	Depend on cause of failure.	Replace P.C. board.





Block distinction		Operation of diagnosis function				Action and Judgment
Check code	Block	Check code	Cause of operation	Air conditioner status	Display flashing error	
01	Serial signal and connecting cable.	04	1) Defective wiring of the connecting cable or miss-wiring. 2) Operation signal has not send from the indoor unit when operation start. 3) Outdoor unit has not send return signal to the indoor unit when operation started. 4) Return signal from the outdoor unit is stop during operation. <ul style="list-style-type: none"> <li>• Some protector (hardware, if exist) of the outdoor unit open circuit of signal.</li> <li>• Signal circuit of indoor P.C. board or outdoor P.C. board is failure in some period.</li> </ul>	Indoor unit operates continue. Outdoor unit stop.	Flashes when error is detected. Flashing stop and outdoor unit start to operate when the return signal from the outdoor unit is normal.	1) to 3) The outdoor unit never operate. <ul style="list-style-type: none"> <li>• Check connecting cable and correct if defective wiring.</li> <li>• Check 25A fuse of inverter P.C. board.</li> <li>• Check 3.15A fuse of inverter P.C. board.</li> <li>• Check operation signal of the indoor unit by using diode. Measure voltage at terminal block of the indoor unit between No.2 and No.3 (or L2 and S) If signal is varied 15-60V continuously, replace inverter P.C. board. If signal is not varied, replace indoor P.C. board.</li> </ul> 4) The outdoor unit abnormal stop at some time. <ul style="list-style-type: none"> <li>• If the other check codes are found concurrently, check them together.</li> <li>• Check protector (hardware) such as Hi-Pressure switch, Thermal-Relay, etc.</li> <li>• Check refrigerant amount or any possibility case which may caused high temperature or high pressure.</li> <li>• Check operation signal of the indoor unit by using diode. Measure voltage at terminal block of the indoor unit between No.2 and No.3 (or L2 and S) If signal is varied 15-60V continuously, replace inverter P.C. board. If signal is not varied, replace indoor P.C. board.</li> </ul>

**Note : Operation signal of the indoor unit shall be measured in the sending period as picture below.**

**Sending signal of the indoor unit when have not return signal from the outdoor unit.**

\* Signal send only 1 minute and stop. Because of return signal from outdoor unit has not received.  
 \*\* Signal resend again after 3 minutes stop. And the signal will send continuously.  
 \*\*\* 1 minute after resending, the indoor unit display flashes error.

Block distinction		Operation of diagnosis function			Air conditioner status	Display flashing error	Action and Judgment
Check code	Block	Check code	Cause of operation				
02	Outdoor P.C. board	14	Current on inverter circuit is over limit in short time. <ul style="list-style-type: none"> <li>• Inverter P.C. board is failure, IPM shortage, etc.</li> <li>• Compressor current is higher than limitation, lock rotor, etc.</li> </ul>	All OFF	Flashes after error is detected 8 times*.	<ol style="list-style-type: none"> <li>1. Remove connecting lead wire of the compressor, and operate again.</li> <li>2. If outdoor fan does not operate or operate but stop after some period, replace the inverter P.C. board.</li> <li>3. If outdoor fan operates normally, measure 3-Phase output of inverter P.C. board (150-270VAC) at the connecting lead wire of compressor.</li> <li>4. If 3-Phase output is abnormal, replace inverter P.C.Board.</li> <li>5. If 3-Phase output is normal, replace compressor. (lock rotor, etc.)</li> </ol>	
		15	Compressor position-detect circuit error or short-circuit between winding of compressor.	All OFF	Flashes after error is detected 8 times*.	<ol style="list-style-type: none"> <li>1. Remove connecting lead wire of the compressor, and operate again.</li> <li>2. If outdoor fan does not operate or operation but stop after some period, replace the inverter P.C. board.</li> <li>3. If outdoor fan operates normally, measure resistance of compressor winding. If circuit is shortage, replace the compressor.</li> </ol>	
		17	Current-detect circuit of inverter P.C. board error.	All OFF	Flashes after error is detected 4 times*.	Even if trying to operate again, all operations stop, replace inverter P.C. board.	
		18	TE sensor ; The heat exchanger temperature sensor of the outdoor unit either TS sensor ; Suction pipe temperature sensor, out of place, disconnection or shortage.	All OFF	Flashes after error is detected 4 times*.	<ol style="list-style-type: none"> <li>1. Check sensors TE, TS and connection.</li> <li>2. In case of the sensors and its connection is normal, check the inverter P.C. board.</li> </ol>	
		19	TD sensor ; Discharge pipe temperature sensor is disconnection or shortage.	All OFF	Flashes after error is detected 4 times*.	<ol style="list-style-type: none"> <li>1. Check sensors TD and connection.</li> <li>2. In case of the sensor and its connection is normal, check the inverter P.C. board.</li> </ol>	
		1A	Outdoor fan failure or its drive-circuit on the inverter P.C. board failure.	All OFF	Flashes after error is detected 8 times*.	<ol style="list-style-type: none"> <li>1. Check the motor, measure winding resistance, shortage or lock rotor.</li> <li>2. Check the inverter P.C. board.</li> </ol>	
		1b	TO sensor ; The outdoor temperature sensor is disconnection or shortage.	Operation continues.	Record error after detected 4 times*. But does not flash display.	<ol style="list-style-type: none"> <li>1. Check sensors TO and connection.</li> <li>2. In case of the sensor and its connection is normal, check the inverter P.C. board.</li> </ol>	

Block distinction		Operation of diagnosis function				Action and Judgment
Check code	Block	Check code	Cause of operation	Air conditioner status	Display flashing error	
			Compressor drive output error. (Relation of voltage, current and frequency is abnormal) <ul style="list-style-type: none"> <li>Overloading operation of compressor caused by over-charge refrigerant, P.M.V. failure, etc.</li> <li>Compressor failure (High current).</li> </ul>	All OFF	Flashes after error is detected 8 times*.	<ol style="list-style-type: none"> <li>Check installation conditions such as packed valve opening, refrigerant amount and power supply (rate <math>\pm 10\%</math>, both of operation and non operation condition).</li> <li>Check P.M.V. by measure the resistance of the coil and confirm its operation (sound of initial operation, etc.)</li> <li>Observe any possibility cause which may affect operation load of compressor.</li> <li>Operate again. If compressor operation is failure when 20 seconds passed (count time from operation starting of compressor), replace compressor.</li> </ol>
<p>* 4 or 8 times ; When first error is detected, error is count as 1 time, then once operation is stop and re-started.                      After re-starting operation within 6 minutes, if same error is detected, error count is add (count become 2 times)                      When error count comes 4 or 8 times, record error to check code. But after re-starting operation, if no error is detected and air conditioner can operate more than 6 minutes, error count is cleared.</p>						
	The others (including compressor)		Return signal of the outdoor unit has been sent when operation start. But after that, signal is stop some time. <ul style="list-style-type: none"> <li>Instantaneous power failure.</li> <li>Some protector (hardware) of the outdoor unit open circuit of signal.</li> <li>Signal circuit of indoor P.C. board or outdoor P.C. board is failure in some period.</li> </ul>	Indoor unit operates continue. Outdoor unit stop.	Flashes when error is detected. Flashing stop and outdoor unit start to operate when the return signal from the outdoor unit is normal.	<ol style="list-style-type: none"> <li>Check power supply (Rate <math>\pm 10\%</math>)</li> <li>If the air conditioner repeat operates and stop with interval of approx. 10 to 40 minutes.                             <ul style="list-style-type: none"> <li>Check protector (hardware) such as Hi-Pressure switch, Thermal-Relay, etc.</li> <li>Check refrigerant amount, packed valve opening and any possibility cause which may affect high temperature or high pressure.</li> </ul> </li> <li>Check operation signal of the indoor unit by using diode. Measure voltage at terminal block of the indoor unit between No.2 and No.3 (or L2 and S)                              If signal is varied 15-60V continuously, replace inverter P.C. board.                              If signal is not varied, replace indoor P.C. board.</li> </ol>

Block distinction		Operation of diagnosis function				Action and Judgment
Check code	Block	Check code	Cause of operation	Air conditioner status	Display flashing error	
		<b>1D</b>	Compressor does not rotate. Because of missed wiring, missed phase or shortage.	All OFF	Flashes after error is detected 8 times*.	<ol style="list-style-type: none"> <li>1. Remove connecting lead wire of the compressor, and operate again.</li> <li>2. If outdoor fan does not operate or operation but stop after some period, replace the inverter P.C. board.</li> <li>3. If outdoor fan operates normally, measure 3-Phase output of inverter P.C. board (150-270VAC) at the connecting lead wire of compressor.</li> <li>4. If 3-Phase output is abnormal, replace inverter P.C.Board.</li> <li>5. If 3-Phase output is normal, measure resistance of compressor winding.</li> <li>6. If winding is shortage, replace the compressor.</li> </ol>
		<b>1E</b>	Discharge temperature exceeded 117°C.	All OFF	Flashes after error is detected 4 times*.	<ol style="list-style-type: none"> <li>1. Check sensors TD.</li> <li>2. Check refrigerant amount.</li> <li>3. Check P.M.V. by measure the resistance of the coil and confirm its operation (sound of initial operation, etc.)</li> <li>4. Observe any possibility cause which may affect high temperature of compressor.</li> </ol>
		<b>1F</b>	Compressor is high current though operation Hz is decreased to minimum limit. <ul style="list-style-type: none"> <li>• Installation problem.</li> <li>• Instantaneous power failure.</li> <li>• Refrigeration cycle problem.</li> <li>• Compressor break down.</li> <li>• Compressor failure (High current).operation, etc.)</li> </ul>	All OFF	Flashes after error is detected 8 times*.	<ol style="list-style-type: none"> <li>1. Check installation conditions such as packed valve opening, refrigerant amount and power supply (rate <math>\pm 10\%</math>, both of operation and non operation condition).</li> <li>2. Check P.M.V. by measure the resistance of the coil and confirm its operation (sound of initial operation, etc.)</li> <li>3. Observe any possibility cause which may affect high current of compressor.</li> <li>4. If 1, 2 and 3 are normal, replace compressor.</li> </ol>

Block distinction		Operation of diagnosis function				Action and Judgment
Check code	Block	Check code	Cause of operation	Air conditioner status	Display flashing error	
		21	<p>Return signal of the outdoor unit has been sent when operation start. But after that, signal is stop some time.</p> <ul style="list-style-type: none"> <li>Instantaneous power failure.</li> <li>Some protector (hardware) of the outdoor unit open circuit of signal.</li> <li>Signal circuit of indoor P.C. board or outdoor P.C. board is failure in some period.</li> <li>TE, TC high temperature TE for cooling operation TC for heating operation.</li> </ul>	<p>Indoor unit operates continue. Outdoor unit stop.</p>	<p>Flashes when error is detected 11 times*. Flashing stop and outdoor unit start to operate when the return signal from the outdoor unit is normal.</p>	<ol style="list-style-type: none"> <li>Check power supply (Rate <math>\pm 10\%</math>)</li> <li>If the air conditioner repeat operate and stop with interval of approx. 10 to 40 minutes. <ul style="list-style-type: none"> <li>Check protector (hardware) such as Hi-Pressure switch, Thermal-Relay, etc.</li> <li>Check refrigerant amount, packed valve opening and any possibility cause which may affect high temperature or high pressure.</li> </ul> </li> <li>Check operation signal of the indoor unit by using diode. Measure voltage at terminal block of the indoor unit between No.2 and No.3 (or L2 and S) If signal is varied 15-60V continuously, replace inverter P.C. board. If signal is not varied, replace indoor P.C. board.</li> <li>Check and clean heat exchanger area Indoor and Outdoor unit.</li> </ol>
<p>* 4, 8 or 11 times ; When first error is detected, error is count as 1 time, then once operation is stop and re-started. After re-starting operation within 6 minutes, if same error is detected, error count is add (count become 2 times) When error count comes 4, 8 or 11 times, record error to check code. But after re-starting operation, if no error is detected and air conditioner can operate more than 6 minutes, error count is cleared.</p>						

## 11-5. Judgment of Trouble by Symptom

### 11-5-1. Wiring Failure (Interconnecting and Serial Signal)

#### Wire)(1) Outdoor unit does not operate

- 1) Is the voltage between ② and ③ of the indoor terminal block varied?
- 2) Confirm that transmission from indoor unit to outdoor unit is correctly performed based upon the following diagram.

#### NOTE

- Measurement should be performed 2 minutes and 30 seconds after starting of the operation.
- Be sure to prepare a diode for judgment.

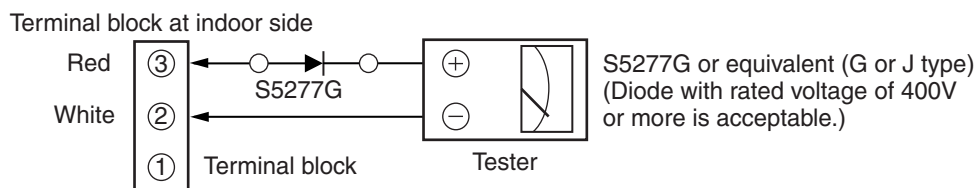

Normal time : Voltage swings between DC15 and 60V. .... Inverter Assembly check

Abnormal time : Voltage does not vary.

#### (2) Outdoor unit stops in a little while after operation started

<Check procedure> Select phenomena described below.

- 1) The outdoor unit stops 10 to 20 minutes after operation started, and 10 minutes or more are required to restart the unit.

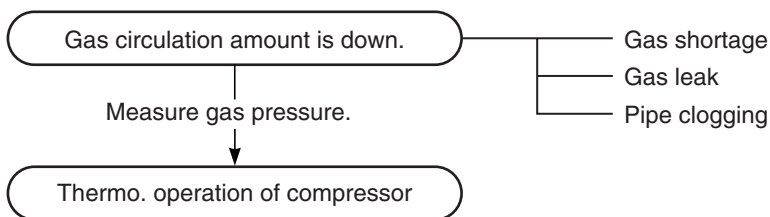

- 2) If the unit stops once, it does not operate until the power will be turned on again.

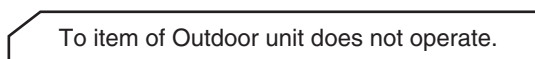

- 3) The outdoor unit stops 10 minutes to 1 hour after operation started, and an alarm is displayed. (Discharge temp. error check code 03, 1E Sensor temp. error check code 02, 1C)

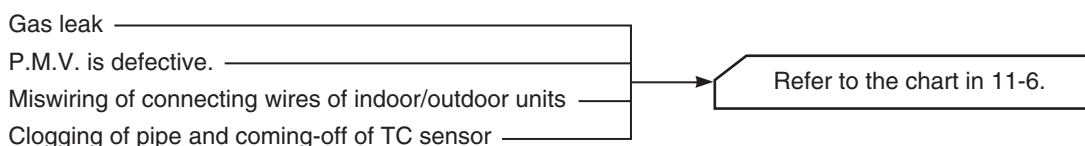

## Service Support Function (LED Display, Switch Operation)

### 1. Outline

A various setup and operation check can be performed by DIP switches at 2 positions (SW801, SW802) and the pushdown button switches (SW800) on the outdoor control P.C. board MCC-5071.

### Operation part

Part No.	Specifications	Operation contents
SW800	Pushdown button switch	Performs the specific operation to check maintenance and various initial settings.
SW801	DIP switch	
SW802	DIP switch	

### Display part

Part No.	Specifications	Operation contents
D502, D511, D517	Orange LED	Indoor/Outdoor communication (Serial communication) signal display (Receive signal from indoor signal)
D501, D508, D515	Green LED	Indoor/Outdoor communication (Serial communication) signal display (Send signal from outdoor signal)
D800	Green LED	(1) Power-ON display When the power of the outdoor unit is turned on, D800 LED goes on.
D801 to D805	Red LED	(2) Error display When the outdoor controller detects some errors, some LEDs go on or flash according to the error as described in Error display table. (Refer to 11-6)
		(3) Specific operation display When SW800 is pushed and a specific operation is operated, some LEDs go on or flash.

\* Every LED is colorless when it goes off.

### Control P.C.B MCC-5071

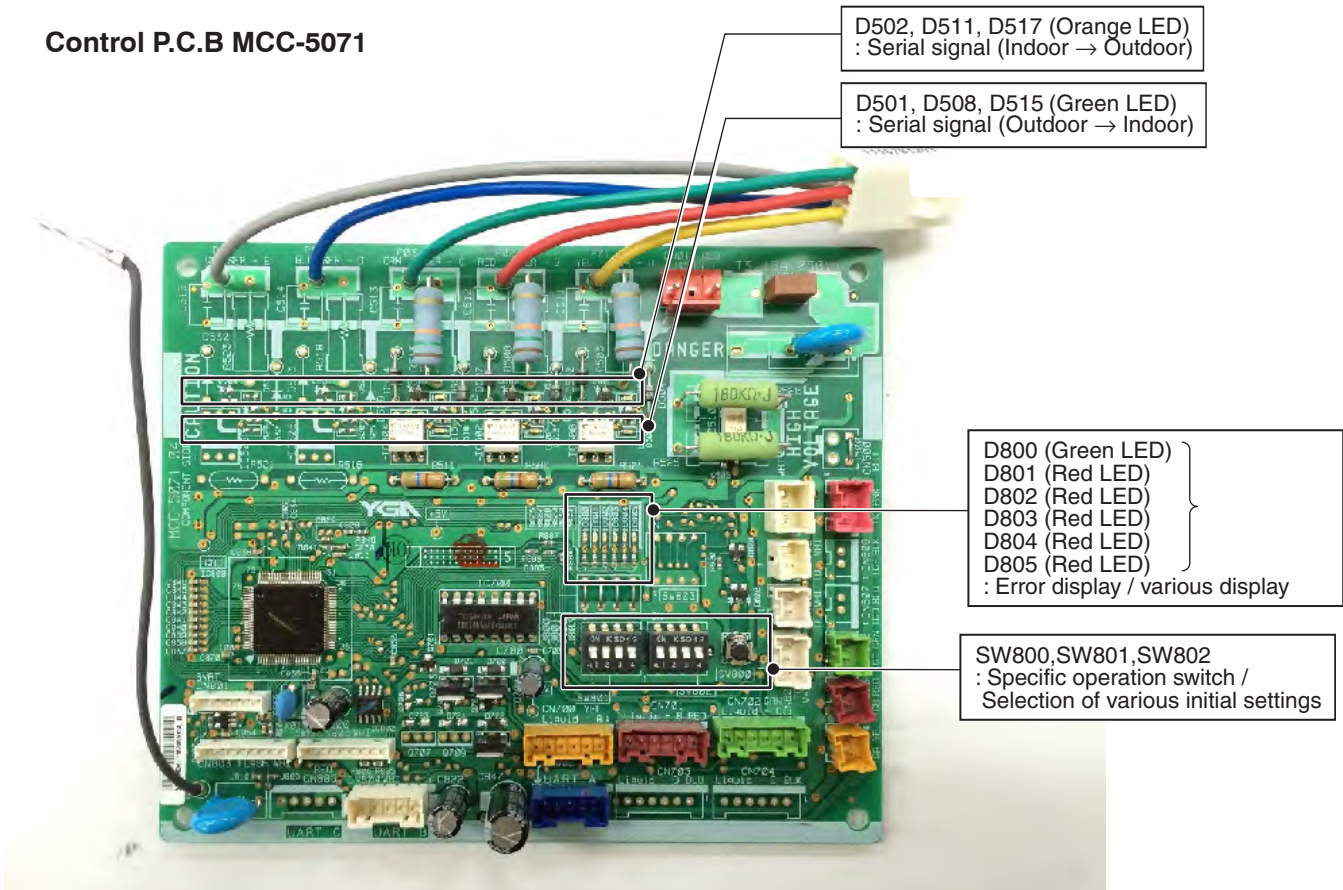

## 11-6. Trouble Diagnosis by Outdoor LED

For the outdoor unit, the self-diagnosis is possible by LED (Green) and five LEDs (Red).

\* LED (Green)(D800) and LEDs (Red)(D801 to D805) are provided on the control P.C. board MCC-5071.

1. If there is an error, LED (Red or Green) goes on or flashes according to the error as described in the below table.
2. When there are two or more errors, LEDs go on cyclically.
3. Usually, LED (Green)(D800) goes on.

### (Legend)

- ◎ D800 (Green)  
 ○ D801 (Red)  
 ● D802 (Red)                      ● : Go off, ○ : Go on, ◎ : Flash  
 ● D803 (Red)  
 ● D804 (Red)  
 ● D805 (Red)

PMV : Pulse Motor Valve

	LED display						Indoor check code	Description
	D800	D801	D802	D803	D804	D805		
	○	●	●	●	●	●	—	During normal operation
	●	○	●	●	●	●	07	Case thermo. operation, Power supply error
	●	●	○	●	●	●	14	Driving element short-circuit
	●	○	○	●	●	●	16	Position detection circuit error
	●	●	●	○	●	●	17	Current detection circuit error
	●	○	●	○	●	●	1C	Compressor system error, Compressor lock
	●	●	○	○	●	●	19	Discharge temp. sensor (TD) error
	●	○	○	○	●	●	1A	Fan system error
*1	●	●	●	●	○	●	1B	Outside temp. sensor (TO) error
	●	○	●	●	○	●	1D	Compressor lock
	●	●	○	●	○	●	1E	Discharge temp. error, gas leakage
	●	○	○	●	○	●	1F	Compressor break down
	●	●	●	○	○	●	18	Suction temp. sensor (TS) error
	●	○	●	○	○	●	18	Heat exchanger temp. sensor (TE) error
*2	●	○	○	○	○	●	1C	A room gas side temp. sensor (TGa) error
*2	●	○	●	●	●	○	1C	B room gas side temp. sensor (TGb) error
*2	●	○	○	●	●	○	1C	C room gas side temp. sensor (TGc) error
	●	○	○	○	●	○	1C	Gas leak detection, PMV error
	●	○	○	●	○	○	1C	Communication error between MCU
	●	○	●	○	○	○	1C	Communication error between MCU
	●	●	○	○	○	○	1C	Communication error between MCU
	◎	○	●	●	●	●	20	PMV error for A room
	◎	●	○	●	●	●	20	PMV error for B room
	◎	●	●	○	●	●	20	PMV error for C room
	●	○	○	○	○	○	21	High pressure SW system error

\*1: Back-up operation is performed without error display of the indoor unit.

\*2: Operated normally when the air conditioners in other rooms are driven.







Check code	Outdoor LED display	Check and troubleshooting (Item without special mention indicates part of outdoor unit.)
[07]	●○●●●●●	<p><b>[Case thermo operation, Power supply error ]</b></p> <pre> graph TD     Q1{{Is AC mains voltage correct? (198 to 264V)}} -- NO --&gt; A1[Confirm power supply construction. etc.]     Q1 -- YES --&gt; Q2{{Are CN609 of P.C. board MCC-1571 connection and case thermostat correct?}}     Q2 -- NO --&gt; A2[Correct connector. Case thermostat error → Replace.]     Q2 -- YES --&gt; Q3{{Short each pins of CN609. Can compressor operate?}}     Q3 -- NO --&gt; A3[Check outdoor P.C.B MCC-1571. Defect → Replace.]     Q3 -- YES --&gt; Q4{{Is there gas leak? Is there refrigerant shortage?}}     Q4 -- YES --&gt; A4[Repair defective position. Recharge refrigerant.]     Q4 -- NO --&gt; Q5{{Is service valve fully opened?}}     Q5 -- NO --&gt; A5[Open service valve fully.]     Q5 -- YES --&gt; Q6{{Is PMV under correct conditions?}}     Q6 -- NO --&gt; A6[Correct defective position. Replace defective part.]     Q6 -- YES --&gt; A7[Check crushed or broken pipe. Defect → Correct and Replace.]     </pre>
[14]	●●●○●●●●	<p><b>[Short-circuit of compressor drive element]</b></p> <pre> graph TD     Q1{{Are connections of compressor lead and reactor correct? (Check referring to the Wiring diagram.)}} -- NO --&gt; A1[Correct wiring.]     Q1 -- YES --&gt; Q2{{Does the same error occur in operation without compressor lead?}}     Q2 -- YES --&gt; A2[Replace outdoor P.C.B MCC-1571.]     Q2 -- NO --&gt; A3[Check compressor. (Rare short, etc.) Defect → Replace.]     </pre>
[16]	●○○●●●●	<p><b>[Position detection circuit error]</b></p> <div style="border: 1px solid black; padding: 5px; width: fit-content; margin: 0 auto;"> <p>Check outdoor P.C.B MCC-1571. Defect → Replace.</p> </div>
[17]	●●●●○●●●	<p><b>[Current detection circuit error]</b></p> <div style="border: 1px solid black; padding: 5px; width: fit-content; margin: 0 auto;"> <p>Check outdoor P.C.B MCC-1571. Defect → Replace.</p> </div>

Check code	Outdoor LED display	Check and troubleshooting (Item without special mention indicates part of outdoor unit.)
[18]		<p>* There is a possibility that it is one of the following errors. Confirm LED on outdoor P.C. board to judge which error it is. Heat exchanger temp. sensor (TE) error, Suction temp. sensor (TS) error</p> <div style="border: 1px solid black; padding: 5px; margin-bottom: 10px;"> <p><b>●●●○○●</b> [Suction temp. sensor (TS) error]</p> <pre> graph TD     Q1{{Is connection of CN603 on P.C.B MCC-5071 correct? Is resistance value of TS sensor correct?}}     Q1 -- NO --&gt; A1[Correct connector. Sensor error → Replace.]     Q1 -- YES --&gt; A2[Check outdoor P.C.B MCC-5071 Defect → Replace.]                     </pre> </div> <div style="border: 1px solid black; padding: 5px;"> <p><b>●○○○○●</b> [Heat exchanger temp. sensor (TE) error]</p> <pre> graph TD     Q2{{Is connection of CN601 on P.C.B MCC-5071 correct? Is resistance value of TE sensor correct?}}     Q2 -- NO --&gt; A3[Correct connector. Sensor error → Replace.]     Q2 -- YES --&gt; A4[Check outdoor P.C.B MCC-5071 Defect → Replace.]                     </pre> </div>
[19]	●●○○●●	<p><b>[Discharge temp. sensor (TD) error]</b></p> <pre> graph TD     Q3{{Is connection of CN600 on P.C.B MCC-5071 correct? Is resistance value of TD sensor correct?}}     Q3 -- NO --&gt; A5[Correct connector. Sensor error → Replace.]     Q3 -- YES --&gt; A6[Check outdoor P.C.B MCC-5071 Defect → Replace.]                     </pre>
[1A]	●○○○●●	<p><b>[Fan system error]</b></p> <pre> graph TD     Q4{{Is AC mains voltage correct? (198 to 264V)}}     Q4 -- NO --&gt; A7[Check wiring construction. Ask repair of power supply.]     Q4 -- YES --&gt; Q5{{Rotate shaft of the fan motor by hands during power-OFF, Can it rotate smoothly? Is coil resistance of fan motor correct? Between red and white lead wire :12 to 20Ω. Between white and black lead wire :12 to 20Ω. Between black and red lead wire :12 to 20Ω.}}     Q5 -- NO --&gt; A8[Check outdoor P.C.B MCC-1571 Defect → Replace.]     Q5 -- YES --&gt; A9[Replace fan motor.]                     </pre>
[1B]	●●●●○○	<p><b>[Outside temp. sensor (TO) error]</b></p> <pre> graph TD     Q6{{Is connection of CN602 on P.C.B MCC-5071 correct? Is resistance value of TO sensor correct?}}     Q6 -- NO --&gt; A10[Correct connector. Sensor error → Replace.]     Q6 -- YES --&gt; A11[Check outdoor P.C.B MCC-5071 Defect → Replace.]                     </pre>

Check code	Outdoor LED display	Check and troubleshooting (Item without special mention indicates part of outdoor unit.)
[1C]	●○○●●●	<p>* There is a possibility that it is one of the following errors. Confirm LED on outdoor P.C. board to judge which error it is. Compressor system error, Compressor lock, Gas side temp. sensor (TGa to TGc) error, Gas leakage, PMV error</p> <p><b>[Compressor system error, Compressor lock]</b></p> <pre> graph TD     Q1{{Is AC mains voltage correct? (198 to 264V)}} -- NO --&gt; A1[Check wiring construction. Ask repair of power supply.]     Q1 -- YES --&gt; Q2{{Is wire connection correct? Compressor lead (Board side, Compressor Side), Reactor lead, Power supply lead.}}     Q2 -- NO --&gt; A2[Check wire connection and correct it.]     Q2 -- YES --&gt; Q3{{Is compressor under correct condition?}}     Q3 -- YES --&gt; C1((1))     Q3 -- NO --&gt; Q4{{Is there refrigerant stagnation?}}     Q4 -- NO --&gt; A3[Compressor lock -&gt; Replace.]     Q4 -- YES --&gt; Q5{{Does PMV correctly operate?}}     Q5 -- NO --&gt; A4[Check TE, TS sensor and PMV. Detect -&gt; Replace..]     Q5 -- YES --&gt; C2((1))     C2 --&gt; Q6{{Are the power devices on P.C. board MCC-1571 screwed without looseness? (Rear sides of Q201, Q300, Q650, DB01, DB02) Are radiation grease properly applied? (Q201)}}     Q6 -- NO --&gt; A5[Apply radiation grease to objective parts. Retightening of screws. (Be sure not to forget to attach insulating sheet between heat sink and Q300, Q650, DB01, DB02)]     Q6 -- YES --&gt; Q7{{Does something block the ventilation around the heat sink? Does something air flow from the fan?}}     Q7 -- YES --&gt; A6[Remove blocking matter. Correct short-circuit.]     Q7 -- NO --&gt; A7[Check outdoor P.C.B MCC-1571 and MCC-5071. Defect -&gt; Replace]     </pre>

Check code	Outdoor LED display	Check and troubleshooting (Item without special mention indicates part of outdoor unit.)
[1C] (Continued)	●○○○○●	<p><b>[A room gas side temp. sensor (TGa) error]</b></p>
	●○○●●○○	<p><b>[B room gas side temp. sensor (TGb) error]</b></p>
	●○○●●○○	<p><b>[C room gas side temp. sensor (TGc) error]</b></p>
	●○○○○●	<p><b>[Gas leak detection, PMV error]</b></p>

Check code	Outdoor LED display	Check and troubleshooting (Item without special mention indicates part of outdoor unit.)
[1C] (Continued)		<p><b>[Communication error between MCUs]</b></p> <p>Are connections of CN802 on P.C.B MCC-5071 and CN802 on P.C.B MCC-1571 correct?</p> <p>NO → Correct connection.</p> <p>YES → Check outdoor P.C. Boards. Defect → Replace.</p>
		<p><b>[Communication error between MCUs]</b></p> <p>Are connections of CN804 on P.C.B MCC-5071 and CN800 on P.C.B MCC-1571 correct?</p> <p>NO → Correct connection.</p> <p>YES → Check outdoor P.C. Boards. Defect → Replace.</p>
[1D]		<p><b>[Compressor lock]</b></p> <p>Is AC mains voltage correct? (198 to 264V)</p> <p>NO → Check wiring construction. Ask repair of power supply.</p> <p>YES →</p> <p>Is wire connection correct? Compressor lead (Board side, Compressor Side), Reactor lead, Power supply lead.</p> <p>NO → Check wire connection and correct it.</p> <p>YES →</p> <p>Is compressor under correct condition?</p> <p>YES → Check outdoor P.C.B MCC-1571. Defect → Replace.</p> <p>NO →</p> <p>Is there refrigerant stagnation?</p> <p>NO → Compressor lock → Replace.</p> <p>YES →</p> <p>Does PMV correctly operate?</p> <p>NO → Check TE, TS sensors and PMV. Detect → Replace.</p> <p>YES → Check outdoor P.C.B MCC-5071. Defect → Replace.</p>
[1E]		<p><b>[Discharge temp. error]</b></p> <p>Is there gas leak? Is there refrigerant shortage?</p> <p>YES → Repair defective position. Recharge refrigerant.</p> <p>NO →</p> <p>Is PMV under correct conditions?</p> <p>NO → Repair defective position. Replace defective part.</p> <p>YES →</p> <p>Does an abnormal overload happen?</p> <p>YES → Remove and improve the cause of overload.</p> <p>NO →</p> <p>Is connection of CN600 on P.C.B. MCC-5071? Is resistance value of TD sensor correct?</p> <p>NO → Correct connector. Sensor error → Replace.</p> <p>YES → Check outdoor P.C.B MCC-5071. Defect → Replace.</p>

Check code	Outdoor LED display	Check and troubleshooting (Item without special mention indicates part of outdoor unit.)
[1F]	●○○●○○●	<p><b>[Compressor break down]</b></p> <pre> graph TD     Q1{{Is AC mains voltage correct? (198 to 264V)}} -- NO --&gt; A1[Check wiring construction. Ask repair of power supply.]     Q1 -- YES --&gt; Q2{{Is wire connection correct? Compressor lead (Board side, Compressor Side), Reactor lead, Power supply lead.}}     Q2 -- NO --&gt; A2[Check wire connection and correct it.]     Q2 -- YES --&gt; Q3{{Does an abnormal overload happen?}}     Q3 -- YES --&gt; A3[Remove and improve the cause of overload.]     Q3 -- NO --&gt; A4[Check outdoor P.C.B MCC-1571. Defect → Replace.]                     </pre>
[20]	<p>⊙○○●●●●</p> <p>⊙●○○●●●</p> <p>⊙●●○○●●</p>	<p>* There is a possibility that it is one of the following errors. Confirm LED on outdoor P.C. board to judge which error it is. PMV error for A room, B room, C room.</p> <p><b>[PMV error for A room]</b></p> <pre> graph TD     Q1{{Is PMV under correct conditions?}} -- NO --&gt; A1[Repair defective position. Replace defective part.]     Q1 -- YES --&gt; Q2{{Check temp. sensor of A room indoor unit? TA sensor, TC sensor}}     Q2 -- Error --&gt; A2[Correct connector. Sensor error → Replace.]     Q2 -- OK --&gt; A3[Check outdoor P.C.B MCC-5071 and indoor A room P.C. board. Defect → Replace.]                     </pre> <p><b>[PMV error for B room]</b></p> <pre> graph TD     Q1{{Is PMV under correct conditions?}} -- NO --&gt; A1[Repair defective position. Replace defective part.]     Q1 -- YES --&gt; Q2{{Check temp. sensor of B room indoor unit? TA sensor, TC sensor}}     Q2 -- Error --&gt; A2[Correct connector. Sensor error → Replace.]     Q2 -- OK --&gt; A3[Check outdoor P.C.B MCC-5071 and indoor B room P.C. board. Defect → Replace.]                     </pre> <p><b>[PMV error for C room]</b></p> <pre> graph TD     Q1{{Is PMV under correct conditions?}} -- NO --&gt; A1[Repair defective position. Replace defective part.]     Q1 -- YES --&gt; Q2{{Check temp. sensor of C room indoor unit? TA sensor, TC sensor}}     Q2 -- Error --&gt; A2[Correct connector. Sensor error → Replace.]     Q2 -- OK --&gt; A3[Check outdoor P.C.B MCC-5071 and indoor C room P.C. board. Defect → Replace.]                     </pre>

Check code	Outdoor LED display	Check and troubleshooting (Item without special mention indicates part of outdoor unit.)
[21]	* There is a possibility that it is one of the following errors. Confirm LED on outdoor P.C. board to judge which error it is. (1) high-pressure SW system error, (2) power supply error (Vdc), (3) high-pressure protective operation, (4) case thermo operation.	<p data-bbox="502 324 885 369"><b>[High pressure SW system error]</b> High pressure protective operation.</p> <pre> graph TD     Start((●○○○○○)) --&gt; Title[High pressure SW system error]     Title --&gt; B[ⓑ Cooling operation.]     Title --&gt; C[ⓒ Heating operation.]          B --&gt; Q1{Doesn't high pressure switch operate?}     Q1 -- YES --&gt; Q2{Are parts of high pressure switch normal?}     Q2 -- NO --&gt; R1[Parts check Defective -&gt; Replace]     Q2 -- YES --&gt; Q3{Is service valve fully opened?}     Q3 -- NO --&gt; R2[Open service valve fully.]     Q3 -- YES --&gt; R3[Reset the power supply and then do a trial operation according to the season.]          R1 --&gt; R4[Check IPDU PC board Defective -&gt; Replace]     R2 --&gt; R4     R3 --&gt; R4          R4 --&gt; Q4{Does cooling outdoor fan normally operate?}     Q4 -- YES --&gt; Q5{Is there any element which blocks heat exchanger of the outdoor unit?}     Q4 -- NO --&gt; Q6{Is there no fan breakage or coming-off?}     Q6 -- YES --&gt; R5[Repair defective position. Connection of connectors, IPDU, Fan motor, Wiring.]     Q6 -- NO --&gt; R6[Overcharge of refrigerant/ Clogging/Pipe breakage/ Abnormal overload]          Q5 -- YES --&gt; R7[Elimination of blocking element]     Q5 -- NO --&gt; R6          C --&gt; Q7{Does the heating indoor fan normally operate?}     Q7 -- YES --&gt; Q8{Is there any element which blocks indoor heat exchanger?}     Q7 -- NO --&gt; Q9{Are connections of connectors, capacitors and fan motor normal?}     Q9 -- YES --&gt; R7     Q9 -- NO --&gt; R8[Repair defective position.]          Q8 -- YES --&gt; R7     Q8 -- NO --&gt; R9[Clogging by refrigerant overcharge/Pipe breakage/ Abnormal overload]          R9 --&gt; Q10{Are characteristics of TC and TCJ sensor resistance value normal?}     Q10 -- YES --&gt; R10[Check indoor P.C. board Defective -&gt; Replace]     Q10 -- NO --&gt; R11[Replace TC or TCJ sensor.]     </pre>

## 11-7. TROUBLESHOOTING RAS-3M26S3AV-A

### 1. Before Troubleshooting

Each model corresponds to DRED (Demand response enabling device) by AS/NZS 4755.3.1. DRM1, DRM2 and DRM3 are executed as follows, upon directions from the power company, Be sure to confirm they are not operated before usually troubleshooting.

#### Air conditioner demand response

Demand response mode	Description
DRM1	Compressor off
DRM2	$E_{30m} \leq R \times 0.50 \times 0.5$
DRM3	$E_{30m} \leq R \times 0.75 \times 0.5$

\*1:  $E_{30m}$  = total electrical energy (kWh) used by the all conditioner for all purposes (including compressors, controls and fans) over a 30 min period.

\*2: R = rated input electrical power of the air conditioner (kW) at rated capacity in the mode in which it is operating during the demand response event (i.e. cooling or heating).

### 2. Troubleshooting Procedure

When a symptom such as the following table is found without a check code is not displayed on the remote controller, there is a possibility that a demand operation or demand P.C. board is failed, therefore diagnose it according to the following diagram.

No.	Operating conditions of air conditioner
1	Each condition is within the operating condition, but the compressor does not work.
2	Cooling/Heating of the room is poor

#### Diagnosis when compressor does not work

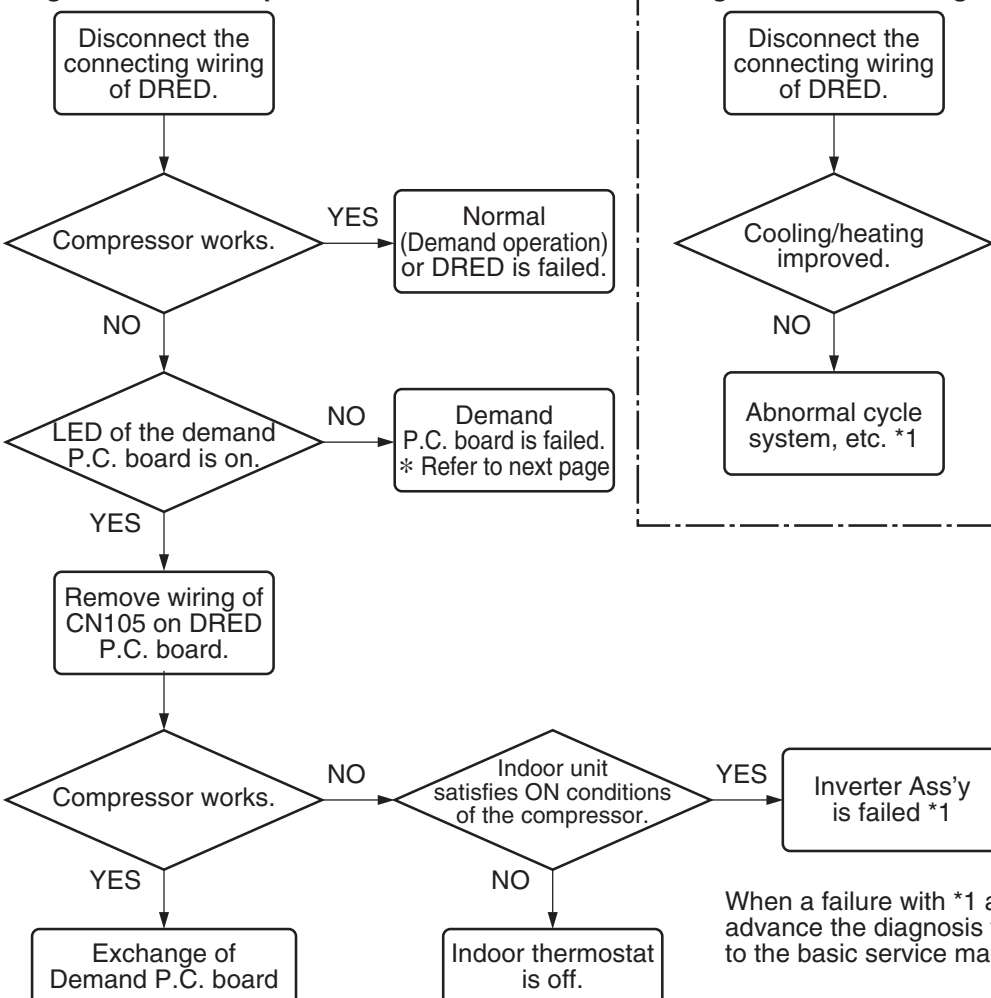

#### Diagnosis when cooling/heating is poor

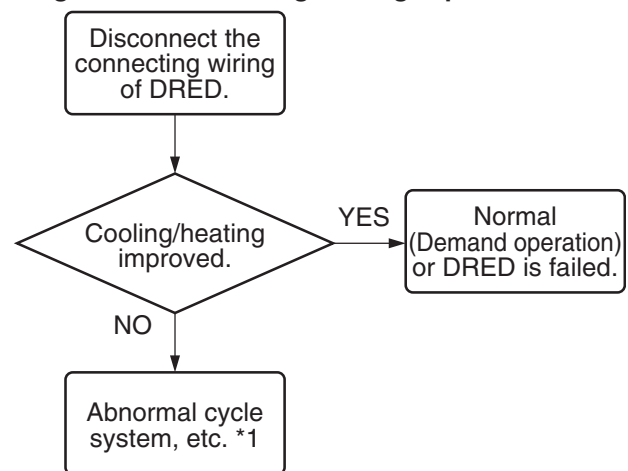

When a failure with \*1 appears, advance the diagnosis further according to the basic service manual.



**Troubleshooting for Demand Unit**

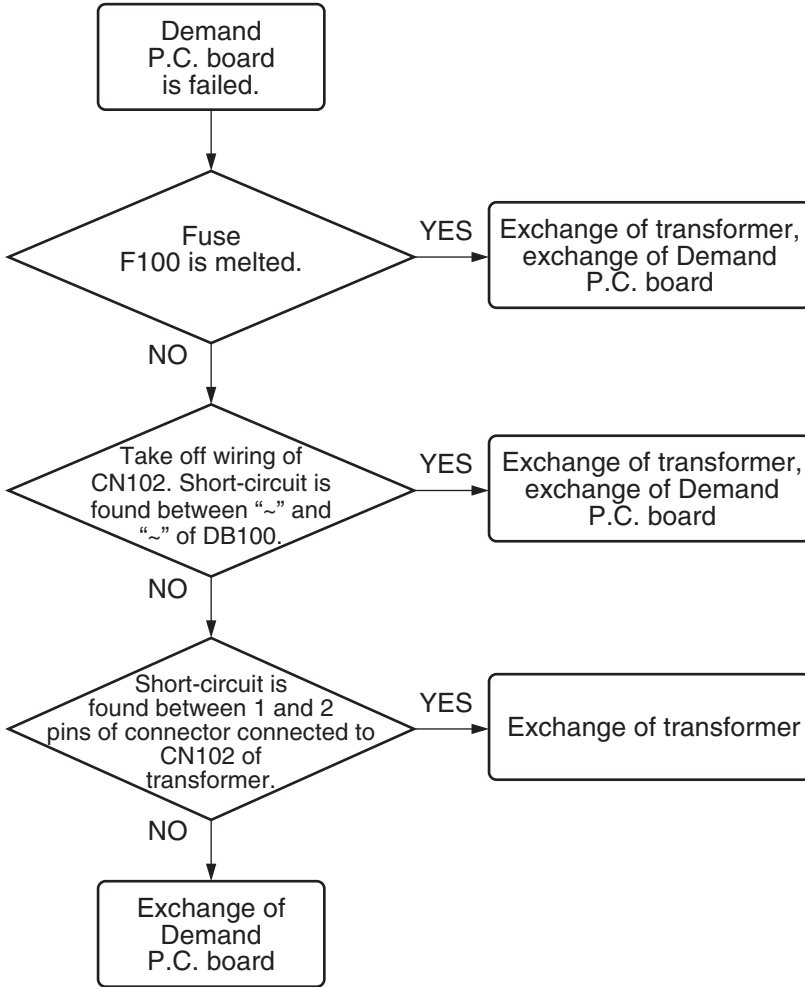

11-8. Inspection of the Main Parts

[1] Sensor characteristic table

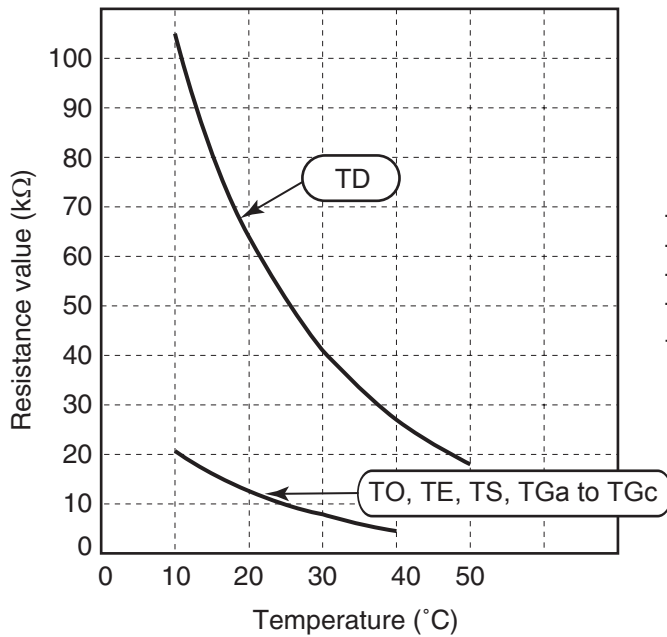

TD : Discharge temp. sensor  
 TO : Outdoor temp. sensor  
 TE : Outdoor heat exchanger temp. sensor  
 TS : Suction temp. sensor  
 TGa to TGc : Gas side temp. sensor

Outdoor Unit

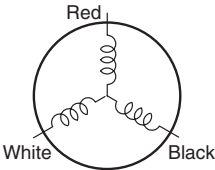
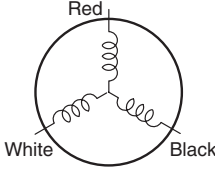
No.	Part name	Checking procedure																								
1	Compressor (Model : DA220A2T-20LD)	Measure the resistance value of each winding by using the tester. <div style="display: flex; align-items: center; justify-content: center;">  <table border="1" style="margin-left: 20px;"> <thead> <tr> <th>Position</th> <th>Resistance value</th> </tr> </thead> <tbody> <tr> <td>Red - White</td> <td rowspan="3" style="text-align: center; vertical-align: middle;"><math>0.61 \pm 0.03\Omega</math></td> </tr> <tr> <td>White - Black</td> </tr> <tr> <td>Black - Red</td> </tr> </tbody> </table> </div> <p style="text-align: right; margin-right: 50px;">Under 20°C</p>	Position	Resistance value	Red - White	$0.61 \pm 0.03\Omega$	White - Black	Black - Red																		
Position	Resistance value																									
Red - White	$0.61 \pm 0.03\Omega$																									
White - Black																										
Black - Red																										
2	Outdoor fan motor (Model : IDF-280-A60-1)	Measure the resistance value of winding by using the tester. <div style="display: flex; align-items: center; justify-content: center;">  <table border="1" style="margin-left: 20px;"> <thead> <tr> <th>Position</th> <th>Resistance value</th> </tr> </thead> <tbody> <tr> <td>Red - White</td> <td rowspan="3" style="text-align: center; vertical-align: middle;"><math>14.8 \pm 1.5\Omega</math></td> </tr> <tr> <td>White - Black</td> </tr> <tr> <td>Black - Red</td> </tr> </tbody> </table> </div> <p style="text-align: right; margin-right: 50px;">For details, refer to Section 11-10.</p>	Position	Resistance value	Red - White	$14.8 \pm 1.5\Omega$	White - Black	Black - Red																		
Position	Resistance value																									
Red - White	$14.8 \pm 1.5\Omega$																									
White - Black																										
Black - Red																										
3	Compressor thermo. Bimetal type (Model : CS-12AL)	Check conduction by using the tester.																								
4	High pressure switch (Model : ACB-4UB83W)	Check conduction by using the tester.																								
5	Outdoor temperature sensor (TO), pipe temperature sensor (TGa, TGb, TGc), discharge temperature sensor (TD), suction temperature sensor (TS), evaporator temperature sensor (TE),	Disconnect the connector, and measure resistance value with the tester. (Normal temperature) <table border="1" style="margin-left: 20px; width: 100%;"> <thead> <tr> <th>Sensor \ Temperature</th> <th>10°C</th> <th>20°C</th> <th>25°C</th> <th>40°C</th> <th>50°C</th> </tr> </thead> <tbody> <tr> <td>TD (kΩ)</td> <td>105</td> <td>64</td> <td>51</td> <td>27</td> <td>18</td> </tr> <tr> <td>TO, TE, TS (kΩ)</td> <td>20.6</td> <td>12.6</td> <td>10.0</td> <td>5.1</td> <td>3.4</td> </tr> <tr> <td>TGa to TGc (kΩ)</td> <td>20.0</td> <td>12.5</td> <td>10.0</td> <td>5.3</td> <td>3.6</td> </tr> </tbody> </table>	Sensor \ Temperature	10°C	20°C	25°C	40°C	50°C	TD (kΩ)	105	64	51	27	18	TO, TE, TS (kΩ)	20.6	12.6	10.0	5.1	3.4	TGa to TGc (kΩ)	20.0	12.5	10.0	5.3	3.6
Sensor \ Temperature	10°C	20°C	25°C	40°C	50°C																					
TD (kΩ)	105	64	51	27	18																					
TO, TE, TS (kΩ)	20.6	12.6	10.0	5.1	3.4																					
TGa to TGc (kΩ)	20.0	12.5	10.0	5.3	3.6																					

## 11-9. How to Simply Judge Whether Outdoor Fan Motor is Good or Bad

### 1. Symptom

- Outdoor fan motor does not rotate.
  - Outdoor fan motor stops within several tens seconds though it started rotating.
  - Outdoor fan motor rotates or does not rotate according to the position where the fan stopped, etc.
- Remote controller check code “02 : Outdoor block, 1A : Outdoor fan drive system error”

### 2. Cause

The following causes are considered when the outdoor fan motor does not normally rotate.

- 1) Mechanical lock of the outdoor fan motor
- 2) Winding error of the outdoor fan motor
- 3) Position-detect circuit error inside of the outdoor fan motor
- 4) Motor drive circuit error of the outdoor P.C. board

### 3. How to simply judge whether outdoor fan motor is good or bad

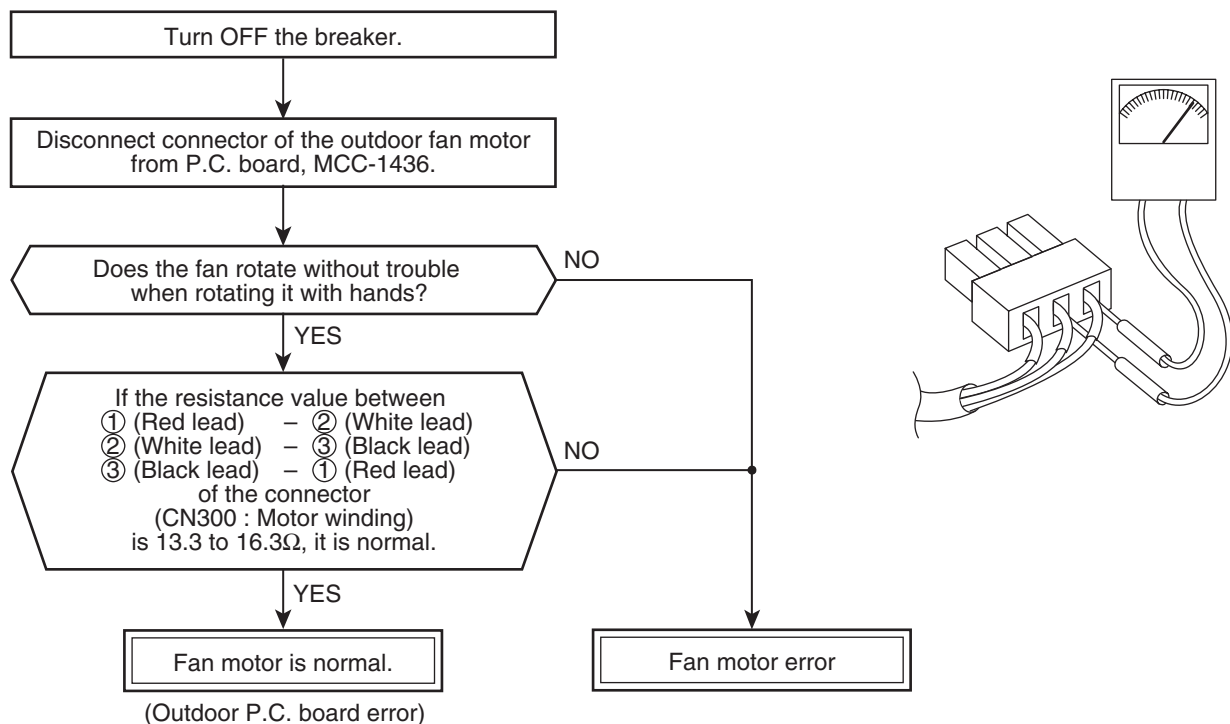

### NOTE

However, GND circuit error inside of the motor may be accepted in some cases when the above check is performed.

When the fan motor does not become normal even if P.C. board is replaced, replace the outdoor fan motor.

<MCC-1571>

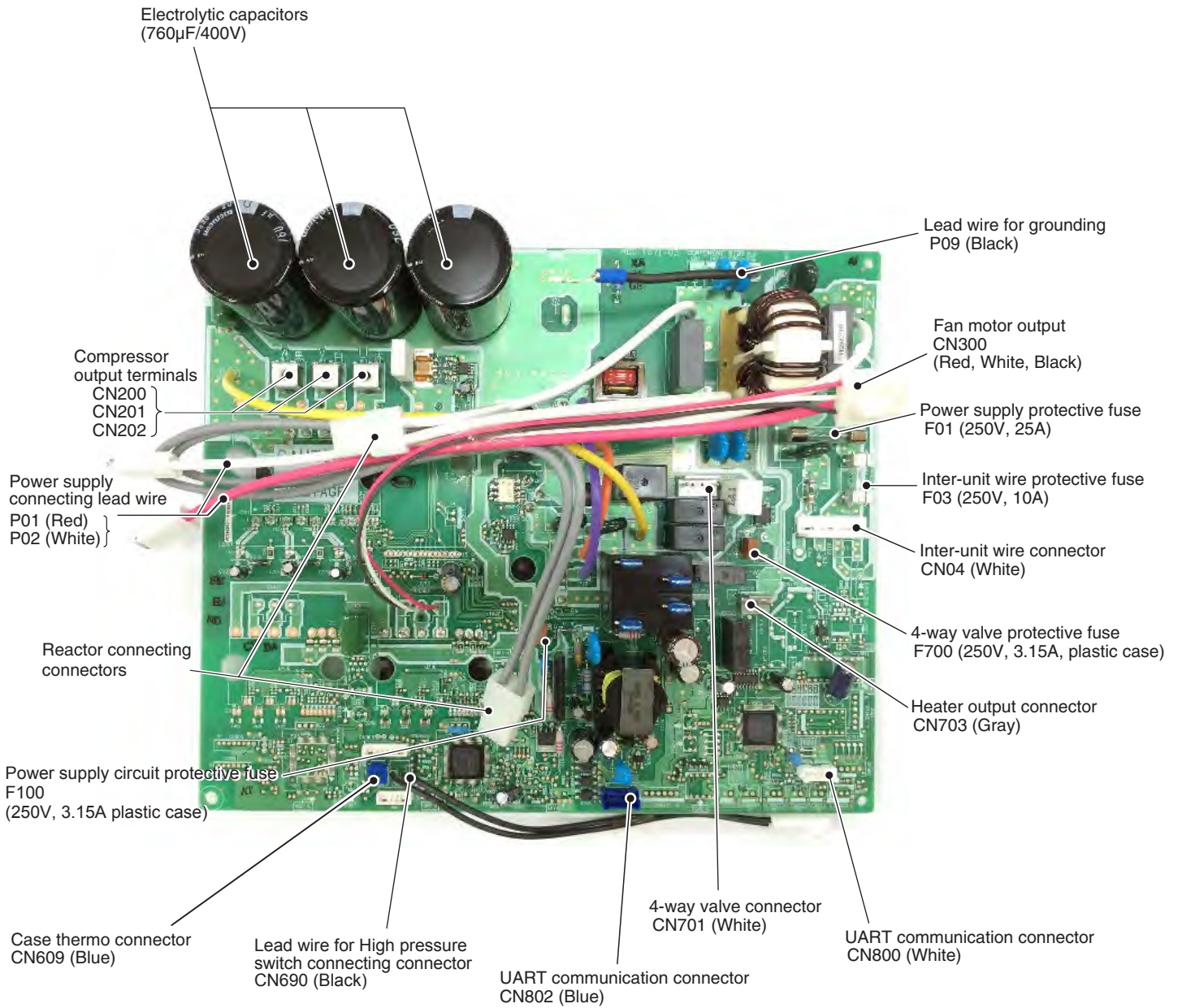

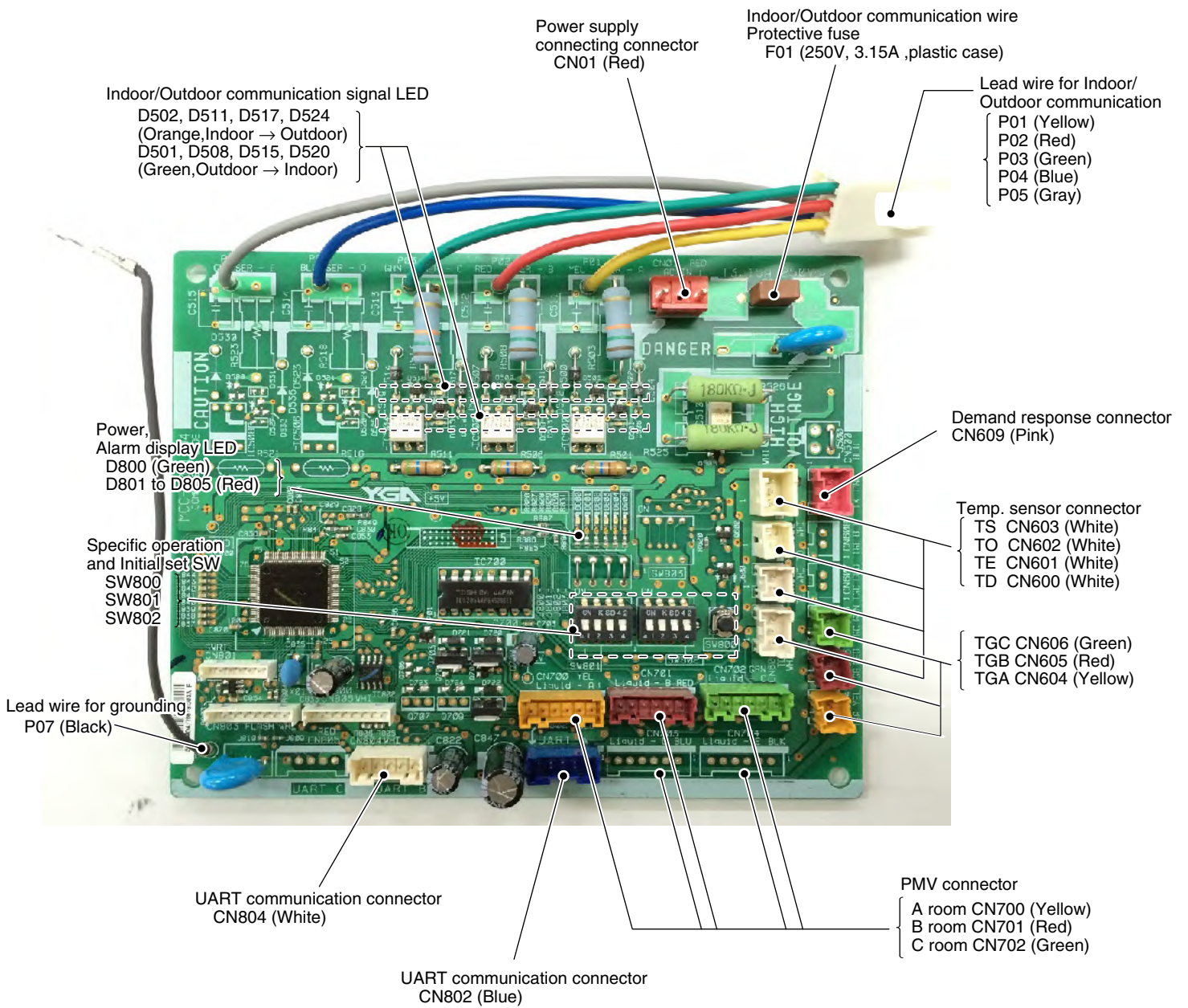

<MCC-5071>





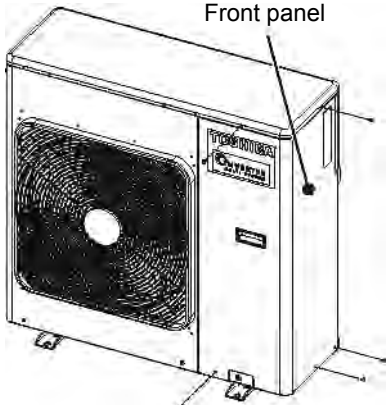
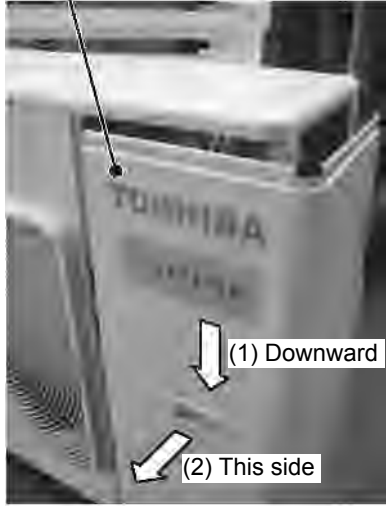
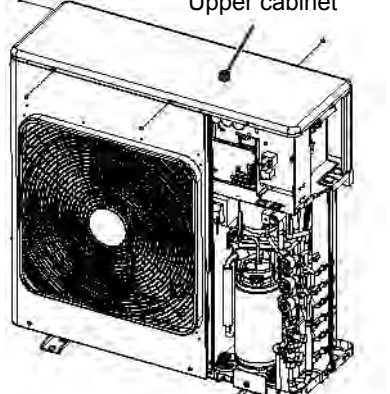

## 12. HOW TO REPLACE THE MAIN PARTS

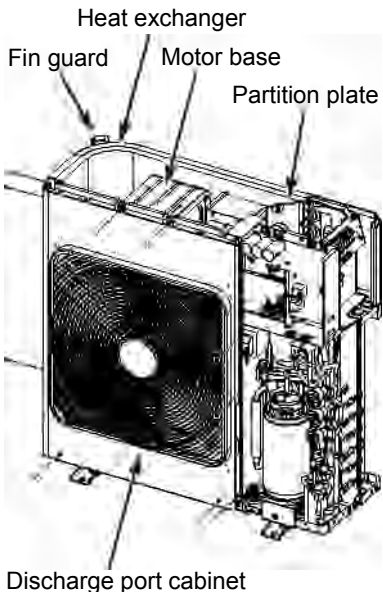
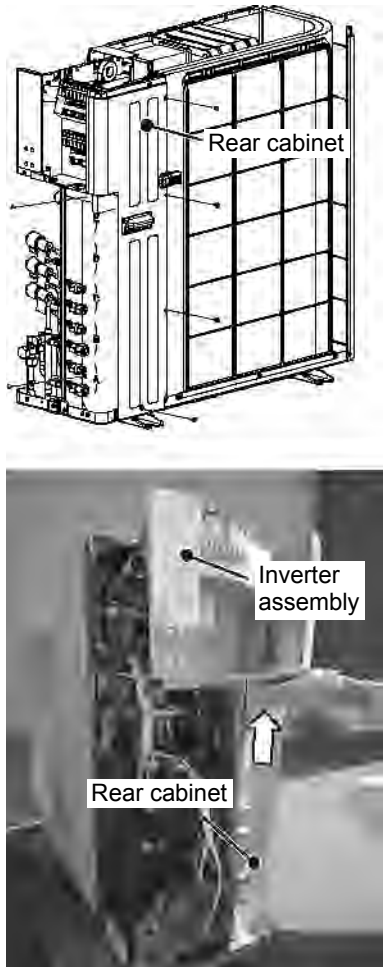

### 12-1. Outdoor Unit

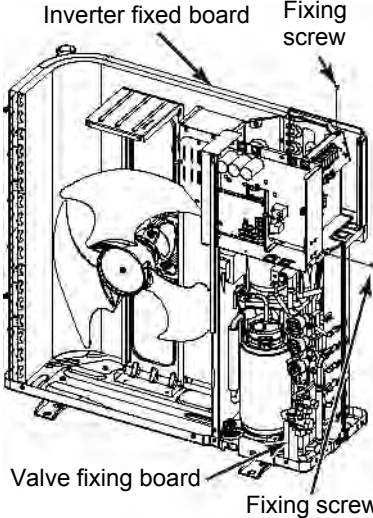
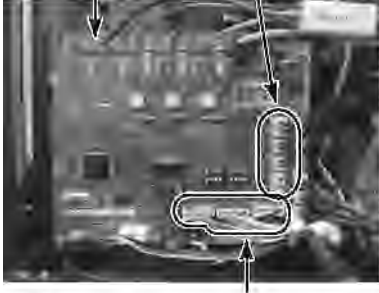
No.	Part name	Procedure	Remarks
①	Common procedure	<p style="text-align: center;"><b>CAUTION</b></p> <hr/> <p>Never forget to put on the gloves at working time; otherwise an injury will be caused by the parts etc.</p> <hr/> <p><b>1. Detachment</b></p> <ol style="list-style-type: none"> <li>1) Stop operation of the air conditioner, and turn off the switch of the breaker.</li> <li>2) Remove the front panel. (Hexagonal screw <math>\varnothing 4 \times 10</math>, 5 pcs.) <ul style="list-style-type: none"> <li>• After taking off screws, draw the front panel ② to this side and remove it while pulling the front panel downward ① .</li> </ul> </li> <li>3) Remove the power supply cable and the indoor/outdoor connecting wire from the cord clamp and the terminal.</li> <li>4) Remove the upper cabinet. (Hexagonal screw <math>\varnothing 4 \times 10</math>, 4 pcs.)</li> </ol> <p><b>2. Attachment</b></p> <ol style="list-style-type: none"> <li>1) Mount the upper cabinet. (Hexagonal screw <math>\varnothing 4 \times 10</math>, 4 pcs.) In this time, insert the fin guard at rear side between the front panel and the heat exchanger (at rear side).</li> <li>2) Connect the power supply cable and the indoor/outdoor connecting wire to the terminal and then fix them with the cord clamp.</li> <li>3) Mount the front panel. (Hexagonal screw <math>\varnothing 4 \times 10</math>, 5 pcs.)</li> </ol>	<p style="text-align: center;">Front panel</p>  <p style="text-align: center;">Front panel</p>  <p style="text-align: center;">Upper cabinet</p>  <p>Insert the fin guard at rear side between the front panel and the heat exchanger (at rear side).</p> 

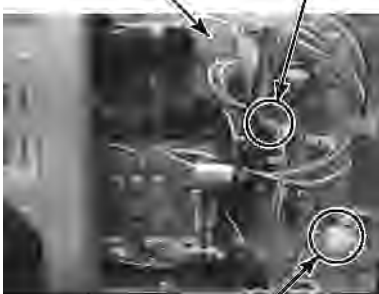
No.	Part name	Procedure	Remarks
②	Discharge port cabinet	<p><b>1. Detachment</b></p> <ol style="list-style-type: none"> <li>1) Perform work of Detachment 1 of ① .</li> <li>2) Take off screws for the discharge port cabinet and the partition plate. (ST1T Ø4 × 8, 3 pcs.)</li> <li>3) Take off screws for the discharge port cabinet and the bottom plate. (Hexagonal screw Ø4 × 10, 2 pcs.)</li> <li>4) Take off screws for the discharge port cabinet and the motor base. (ST1T Ø4 × 8, 2 pcs.)</li> <li>5) Take off screw for the discharge port cabinet and the heat exchanger. (ST1T Ø4 × 8, 1 pc.)</li> <li>6) Take off screws for the discharge port cabinet and the fin guard. (Hexagonal screw Ø4 × 10, 2 pcs.)</li> </ol>	
③	Rear cabinet	<p><b>1. Detachment</b></p> <ol style="list-style-type: none"> <li>1) Perform work of Detachment 1 of ① .</li> <li>2) Take off screw for the rear cabinet and the valve fixed board. (Hexagonal screw Ø4 × 10, 2 pcs.)</li> <li>3) Take off screw for the rear cabinet and the anchor board. (Hexagonal screw Ø4 × 10, 1 pc.)</li> <li>4) Take off screws for the rear cabinet and the heat exchanger. (Hexagonal screw Ø4 × 10, 3 pcs.)</li> <li>5) Remove the rear cabinet by shifting it obliquely backward and upward.</li> </ol>	

No.	Part name	Procedure	Remarks
④	Inverter assembly	<p>1) Perform works Detachment 1 of ① and ③ .</p> <hr/> <p style="text-align: center;"><b>⚠ WARNING</b></p> <hr/> <p>Never disassemble the inverter until 5 minutes after the power supply was turned off because there is a fear that an electric shock may occur.</p> <hr/> <p><b>NOTE)</b></p> <hr/> <p>When working, be sure to use the insulate tools and put on the insulated gloves.</p> <hr/> <p>2) Take off screw for the inverter assembly and the valve fixed board. (ST1T Ø4 × 8, 1 pc.)</p> <p>3) Take off the screw fixed to the terminal fixed board in order to remove the inverter fixed board. (ST1T Ø4 × 8, 1 pc.)</p> <p>4) Remove the connectors that are connected from CDB P.C. board to the other parts.</p> <p>CN600: TD sensor (3P, White)            CN601: TE sensor (2P, White)            CN602: TO sensor (2P, White)            CN603: TS sensor (3P, White)            CN604: TGa sensor (2P, Yellow)            CN605: TGb sensor (2P, Red)            CN606: TGc sensor (2P, Green)            CN609: Demand response connector (3P, Pink)            CN700: PMV coil (6P, Yellow)            CN701: PMV coil (6P, Red)            CN702: PMV coil (6P, Green)</p> <p>5) Cut the bundling band that binds the PMV coil and the relay lead wire.</p> <p>6) Remove the connectors, relay connector and the lead wire that are connected from IPDU P.C. board to the other parts.</p> <p>CN701 : 4-way valve coil (2P, White)            Relay connector for reactor to mount the partition plate (2P: White)            CN609 : Compressor case thermo. (2P: White)            CN690 : Relay connector for High pressure switch (2P: White)</p> <p>7) Remove connectors that are connected from the fan motor to the fan motor relay P.C. board.</p> <ul style="list-style-type: none"> <li>• Unlock the lock of the housing unit and then remove the connectors.</li> </ul>	<p>Inverter fixed board    Fixing screw</p>  <p>Valve fixing board    Fixing screw</p> <p>CDB P.C. board    Temperature sensor</p>  <p>PMV coil</p>  <p>Bundling band</p> <p>DI P.C. board    4-way coil</p>  <p>Fan motor relay connector</p>

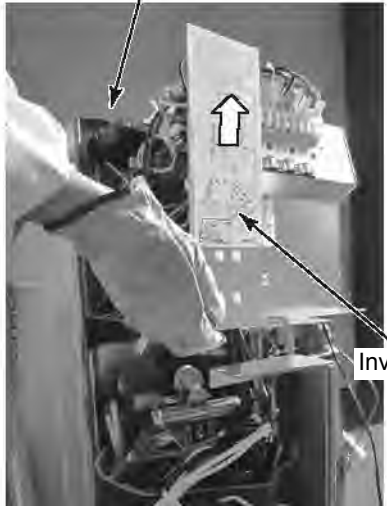
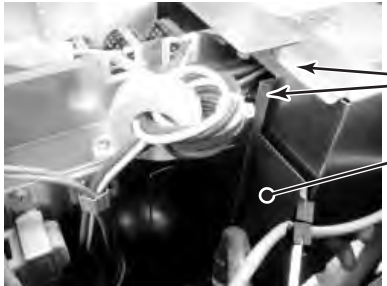

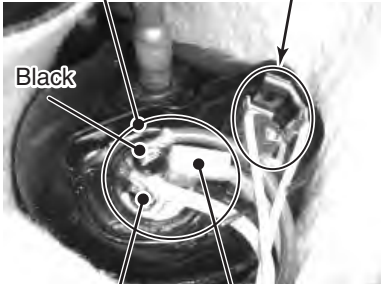

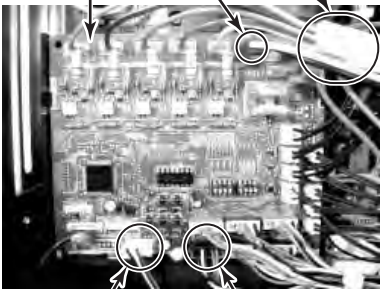
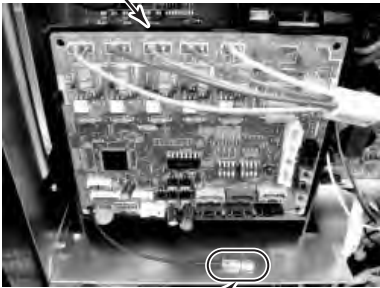
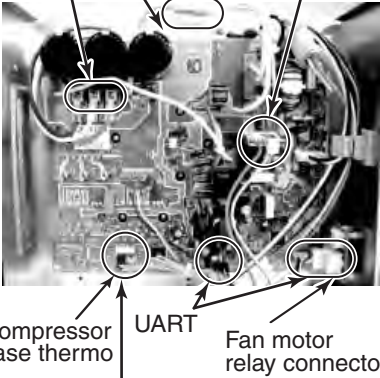
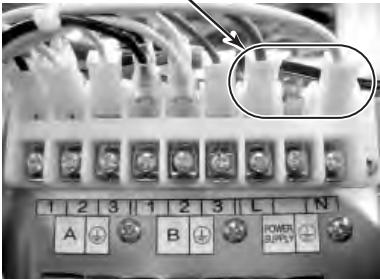

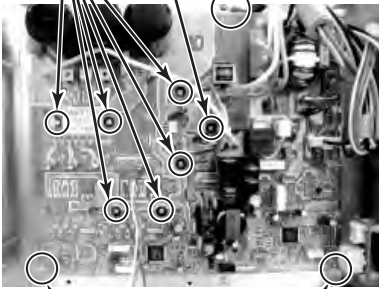
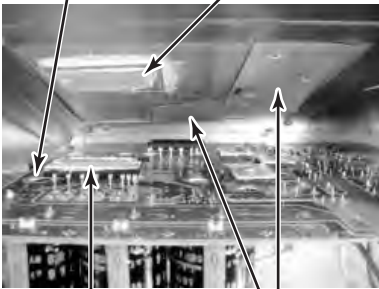
No.	Part name	Procedure	Remarks
④	Inverter assembly (Continued)	<p>8) Remove the soundproof plate (upper).</p> <p>9) Remove the terminal cover of the compressor and then remove the compressor lead of the compressor.</p> <p>10) Pull up the inverter assembly and then remove it.</p> <p style="text-align: center;">Reactor cover side</p>  <p style="text-align: right;">Inverter box side</p> <p>* Hold up both the reactor cover side and the inverter box side and then remove the inverter assembly upward.</p> <p>* Caution to mount the inverter assembly                      When mounting the inverter assembly to the partition plate, be sure to do hooking.</p>  <p style="text-align: right;">Hook Partition cover</p> <p><b>NOTE)</b></p> <hr/> <p>Using the bundling band on the market, be sure to bind the portions which were bound before.</p> <hr/>	<p>Soundproof plate (upper)</p>  <p>Compressor lead      Case thermo</p>  <p>Black      White      Red</p>

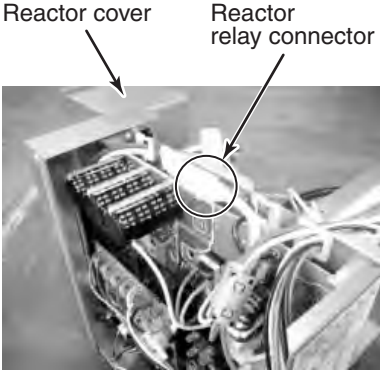
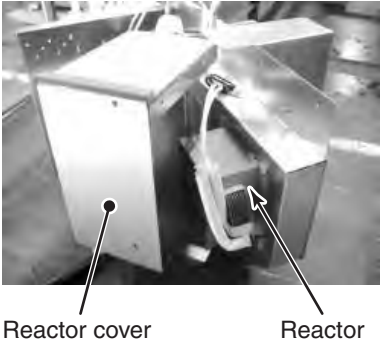
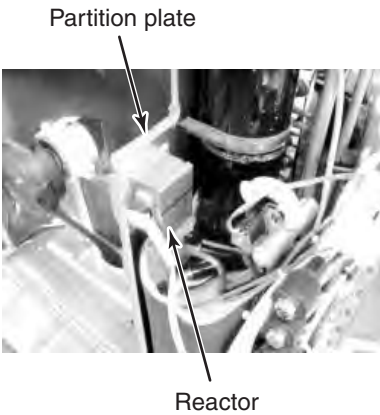
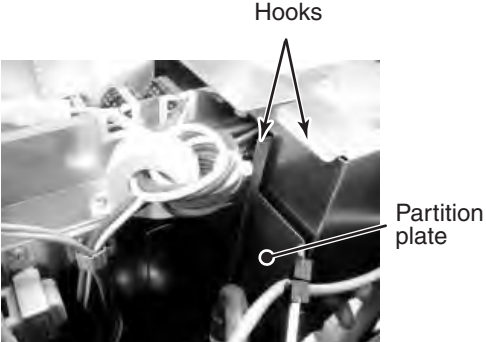

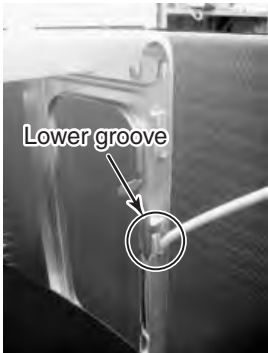
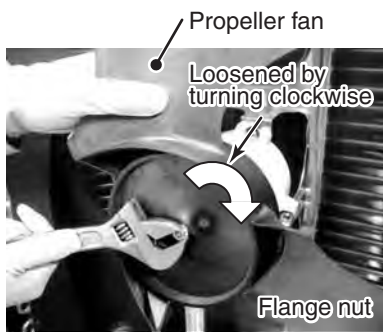
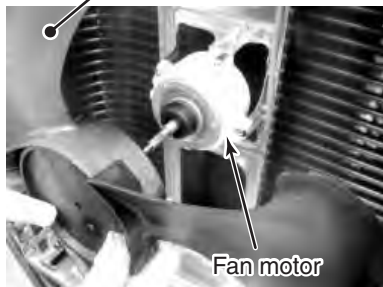
No.	Part name	Procedure	Remarks
⑤	CDB P.C. board	<p>1) Perform works of Detachment 1 of ① and 4) of ④ .</p> <p style="text-align: center;"><b>⚠ CAUTION</b></p> <hr/> <p>Never disassemble the inverter until 5 minutes after the power supply was turned off because there is a fear that an electric shock may occur.</p> <hr/> <p>2) Remove the connector and the relay connector that are connected from CDB P.C. board to IPDU P.C. board, power supply and the inter-unit wire.</p> <p>CN802: UART (5P, Blue)            CN804: UART (5P, White)            CN01: Power supply (3P, Red)            Terminal relay connector (6P, White)</p> <p>* Unlock the lock of the housing unit and then remove the connectors.</p> <p>3) Remove the earth wire of CDB P.C. board (Truss head B tight Ø4 × 6, 1 pc.)</p> <p>4) Remove CDB P.C. board from CDB fixed board.</p> <p>5) Mount a new CDB P.C. board.</p> <p>* When connecting the connectors on CDB P.C. board to support CDB fixed board with hand.</p>	<p>Power supply connector    Terminal relay connector</p> <p>CDB P.C. board</p>  <p>UART (CN804)    UART (CN802)</p> <p>CDB fixed board</p>  <p>Earth screw</p>
⑥	IPDU P.C. board	<p>1) Perform works of Detachment 1 of ① , 3) of ② , ④ and 2), 3) of ⑤ .</p> <p style="text-align: center;"><b>⚠ CAUTION</b></p> <hr/> <p>Never disassemble the inverter until 5 minutes after the power supply was turned off because there is a fear that an electric shock may occur.</p> <hr/> <p>2) Take off screw for CDB fixed board and the inverter box. (ST1T Ø4 × 8, 1 pc.)</p> <p>3) Remove CDB P.C. board assembly.</p> <p>4) Remove the connectors connected to IPDU P.C. board. (4-way valve coil, compressor case thermo, UART × 2, Inter-unit wire)</p> <p>5) Remove the relay connector for fan motor, reactor, and High pressure switch.</p> <p>6) Remove the lead wire connected to IPDU P.C. board.</p> <p>(Tightening torque: 1.47 ± 0.1 N•m)</p> <p>Compressor lead    U : CN200, Red                                      V : CN201, White                                      W : CN202, Black</p> <p>Remove the power supply cable from the power supply terminal block.</p> <p>Power supply lead L: Red            Power supply lead N: White</p>	<p>Reactor relay connector</p> <p>Compressor lead    IPDU P.C. board    4-way valve coil</p>  <p>Compressor case thermo    UART    Fan motor relay connector</p> <p>High pressure switch relay connector</p> <p>Power supply terminal block</p> 

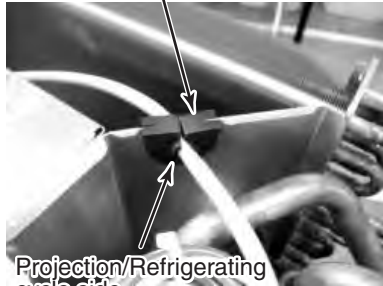

No.	Part name	Procedure	Remarks
⑥	IPDU P.C. board (Continued)	<p>7) Remove the earth wire of IPDU P.C. board. (Truss head B tight screw Ø4 × 6, 1 pc.).</p> <p>8) Take off fixing screws for IPDU P.C. board. (Flange nut to fix element Ø3 × 16, 7 pcs.: Pan head S tight screw to fix P.C. board Ø3 × 20, 1 pc.)</p> <p>9) Remove IPDU P.C. board. (3 supporters)</p> <p><b>NOTE)</b></p> <hr/> <p>Be careful that IPDU P.C. board is difficult to be taken out by radiating grease for the heat sink.</p> <hr/> <p>10) Mount a new IPDU P.C. board.</p> <p><b>NOTE)</b></p> <hr/> <ul style="list-style-type: none"> <li>• Take note that the compressor lead V: CN201 (white) and the reactor lead CN05, CN06 are correctly attached. (For the compressor lead, the transparent sleeve is attached to the circular terminal, and for the reactor lead, the transparent sleeve is not attached to the circular terminal.)</li> <li>• Be sure not to forget to attach the Sub heat sink and also the radiating sheet. (If you apply a little amount of radiating grease beforehand to the rear side of the insulation sheet, the attaching work to the heat sink will become easy.)</li> </ul> <hr/>	<p>Fixing screws for element (7 positions)</p> <p>Earth screw</p>  <p>IPDU P.C. board fixing screw</p> <p>Supporters (3 positions)</p> <p>IPDU P.C. board</p> <p>Radiating grease</p>  <p>Sub heat sink</p> <p>Radiating sheet</p>

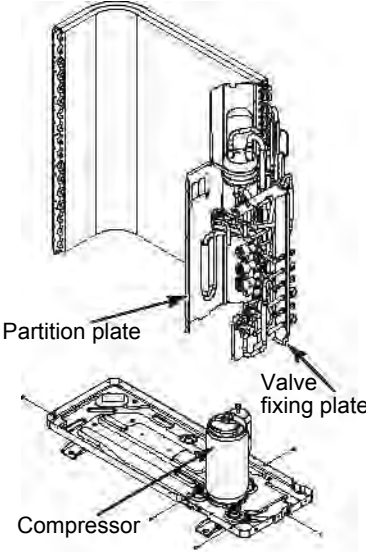
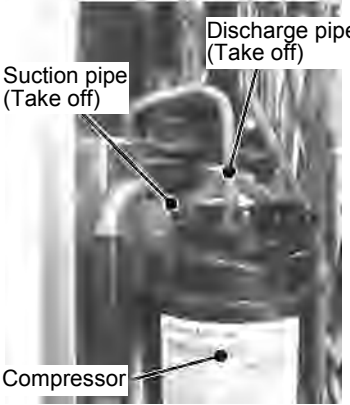

No.	Part name	Procedure	Remarks
⑦	Replacement of reactor	<p><b>1. Reactor to be attached to the inverter assembly</b></p> <ol style="list-style-type: none"> <li>1) Perform works of Detachment 1 of ① and ④ .</li> <li>2) Remove the relay connector of the reactor.</li> <li>3) Remove the reactor cover. (Truss head B tight screw Ø4 × 6, 4 pcs.)</li> <li>4) Remove the reactor. (ST1T Ø4 × 6, 2 pcs.)</li> <li>5) Mount a new reactor.</li> </ol> <p><b>2. Reactor to be attached to the partition plate</b></p> <ol style="list-style-type: none"> <li>1) Perform works of Detachment 1 of ① and ④ .</li> <li>2) Remove the reactor from the partition plate. (ST1T Ø4 × 8, 2 pcs.)</li> <li>3) Mount a new reactor.</li> </ol> <p>* Caution to mount the inverter assembly. When mounting the inverter assembly to the partition plate, be sure to attach the hooks certainly.</p>	 <p>Reactor cover      Reactor relay connector</p>  <p>Reactor cover      Reactor</p>  <p>Partition plate</p> <p>Reactor</p>  <p>Hooks</p> <p>Partition plate</p>

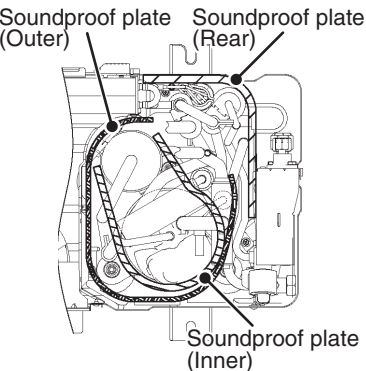
No.	Part name	Procedure	Remarks
⑧	Fan motor	<p>1) Perform works of Detachment 1 of ① and ② .</p> <p>2) Take off flange nut which fixes the fan motor and the propeller fan.            * The flange nut is loosened by turning it clockwise.            (To tighten the flange nut, turn it counterclockwise.)</p> <p>3) Remove the propeller fan.</p> <p>4) Remove the relay connector for fan motor from the inverter.</p> <p>5) Remove the fan motor lead from the fan motor lead fixing rubber of the penetrating part of the partition plate.</p> <p>6) Take off the fixing screws (4 pcs. each) while supporting the fan motor so that it does not fall.            * Caution to assembly of fan motor</p> <ul style="list-style-type: none"> <li>• Tighten the flange nut with 4.95N•m (50kgf•cm).</li> <li>• Adjust length of the fan motor lead fixing rubber so that the slackened fan motor lead does not come to contact with the propeller fan.</li> </ul> <p>Put in the fan motor lead fixing rubber to the partition plate so that the projection comes to the refrigerating cycle side.</p> <ul style="list-style-type: none"> <li>• <b>There provided at 2 positions the grooves to pass the fan motor lead wire into the motor base. Use the lower groove.</b></li> </ul> <div style="display: flex; justify-content: space-around; margin-top: 20px;"> <div style="text-align: center;"> <p>Motor base</p>  </div> <div style="text-align: center;"> <p>Detail A</p>  </div> </div> <div style="text-align: center; margin-top: 20px;"> <p><b>CAUTION</b></p> <hr/> <p>Using the metal band of the motor base, be sure to fix the fan motor lead to the motor base so that the fan motor lead does not come to contact with the propeller fan.</p> <hr/> </div>	<div style="text-align: center; margin-bottom: 10px;">  <p>Propeller fan Loosened by turning clockwise Flange nut</p> </div> <div style="text-align: center; margin-bottom: 10px;">  <p>Propeller fan Fan motor</p> </div> <div style="text-align: center; margin-bottom: 10px;">  <p>Fan motor relay connector</p> </div> <div style="text-align: center; margin-bottom: 10px;">  <p>Fan motor lead fixing rubber Projection/Refrigerating cycle side</p> </div> <div style="text-align: center;">  <p>Fan motor</p> </div>

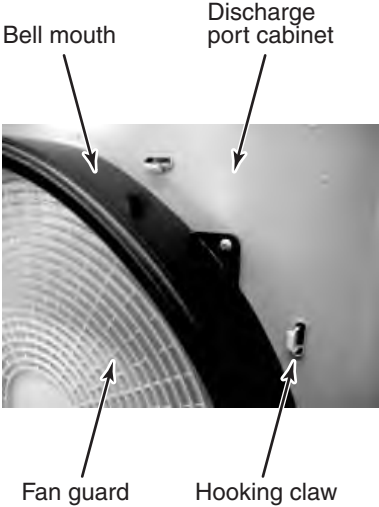



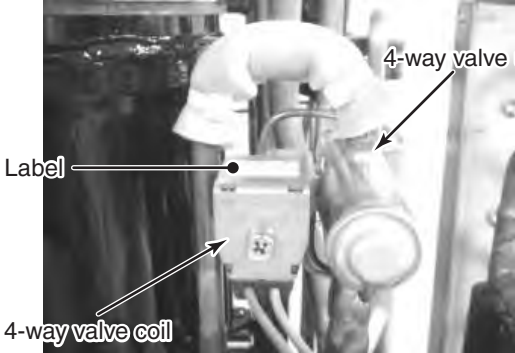
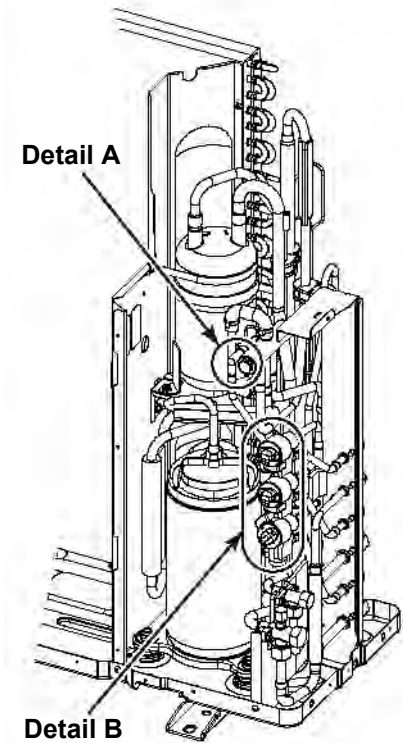
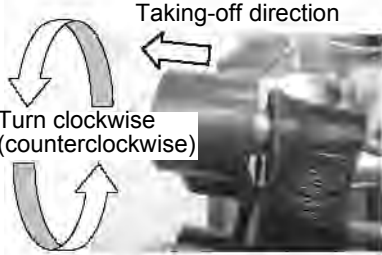

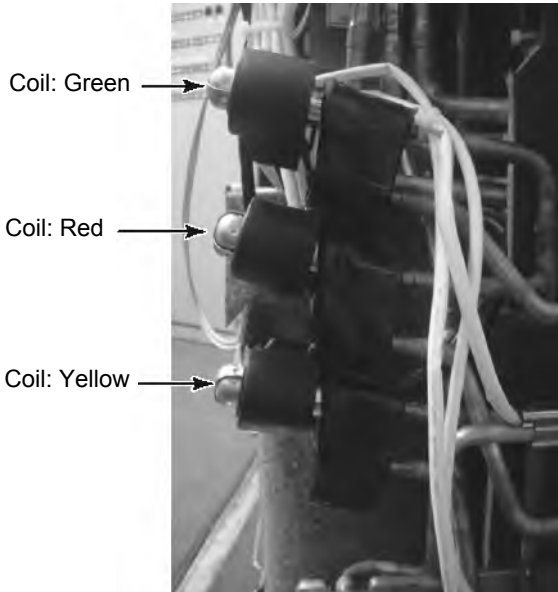
No.	Part name	Procedure	Remarks
⑨	Compressor assembly	<p><b>1. Removal of defective compressor</b></p> <ol style="list-style-type: none"> <li>1) Perform work of Detachment 1 of ① .</li> <li>2) Recover the refrigerant gas from the outdoor unit.</li> <li>3) Perform works of ② , ③ and ④ .</li> <li>4) Remove the soundproof plate and TD sensor.</li> <li>5) Take off fixing screw for the anchor board and the partition plate. (ST1T Ø4 × 8, 1 pc.)</li> <li>6) Take off fixing screws for the anchor board and the heat exchanger. (ST1T Ø4 × 8, 2 pcs.)</li> <li>7) Take off fixing screws for the anchor board and the valve fixing plate. (ST1T Ø4 × 8, 2 pcs.)</li> <li>8) Using a burner, remove the welded parts (discharge pipe, suction pipe) connected to the compressor.</li> </ol> <p><b>NOTE)</b></p> <hr/> <p>Take care that the electric parts, sensors, compressor, and etc. are not caught by flame. (Otherwise operation trouble may occur.)</p> <hr/> <p>9) Pull out the refrigerating cycle upward.</p> <p><b>NOTE)</b></p> <hr/> <p>Pull out the refrigerating cycle by two or more persons.</p> <hr/> <ol style="list-style-type: none"> <li>10) Take off the compressor bolts (3 pcs.) which fix the compressor to the compressor fixing plate.</li> <li>11) Remove the compressor from the compressor fixing plate.</li> </ol> <p><b>NOTE)</b></p> <hr/> <p>A compressor weighs approx. 15kg. Treat a compressor by two or more personals.</p> <hr/> <p>* Caution to assemble compressor</p> <ul style="list-style-type: none"> <li>• Tighten the compressor bolt with 5N•m (50kgf•cm).</li> <li>• Be sure not to burn lead wire of the coil.</li> <li>• Take care there is no missing of sensor.</li> </ul>	 <p>Partition plate</p> <p>Valve fixing plate</p> <p>Compressor</p>  <p>Suction pipe (Take off)</p> <p>Discharge pipe (Take off)</p> <p>Compressor</p> <hr/> <p>* Mount the soundproof plate by passing between the compressor and pipes and between pipes and the partition plate in order of upper, inner, outer and rear sides.</p>  <p>Soundproof plate (Upper)</p>  <p>Soundproof plate (Outer)</p> <p>Soundproof plate (Rear)</p> <p>Soundproof plate (Inner)</p>

No.	Part name	Procedure	Remarks
⑩	Fan guard	<p><b>1. Detachment</b></p> <p>1) Perform works of Detachment 1 of ① and ② .</p> <p style="text-align: center;"><b>CAUTION</b></p> <hr/> <p>Work on the cardboard, cloth, and etc. in order to prevent damage on the product.</p> <hr/> <p>2) Take off the discharge port cabinet and put it as the fan guard side directs downward.</p> <p>3) Take off the hooking claws (8 positions) of the fan guard.</p> <p><b>2. Attachment</b></p> <p>1) Push the hooking claws (8 positions) with hands from the front side and then fix the claws.</p> <p style="text-align: center;"><b>CAUTION</b></p> <hr/> <p>Check all the hooking claws are fixed at each specified position.</p> <hr/>	
⑪	Fin guard	<p><b>1. Detachment</b></p> <p>1) Remove the top plate. (Hexagonal screw <math>\varnothing 4 \times 10</math>, 6 pcs.)</p> <p>2) Take off fixing screws for the fin guard and the anchor board. (Hexagonal screw <math>\varnothing 4 \times 10</math>, 3 pcs.)</p> <p>3) Mount a new fin guard.</p>	

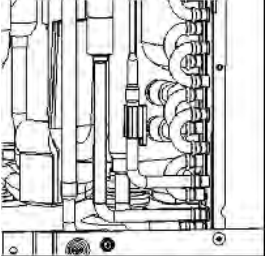
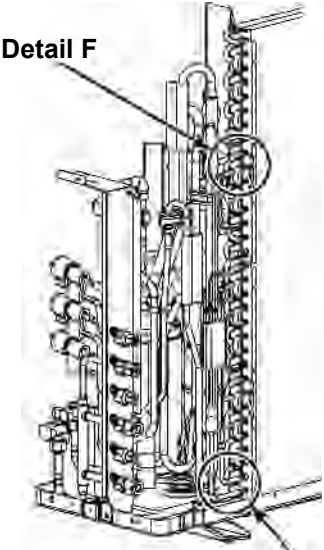
No.	Part name	Procedure	Remarks
⑫	4-way valve coil	<p>* <b>Attachment</b></p> <p>Mount 4-way valve coil so that the label side directs upper side of the cabinet.</p> <p><b>Detail A</b></p> 	 <p><b>Detail A</b></p> <p><b>Detail B</b></p>  <p>Taking-off direction</p> <p>Turn clockwise (counterclockwise)</p> <p>PMV sideways</p> <p>Projection of PMV coil</p>  <p>Concave part of PMV</p> 
⑬	<p>PMV</p> <p>Coil: Green</p> <p>Coil: Red</p> <p>Coil: Yellow</p>	<p><b>1. Detachment</b></p> <ol style="list-style-type: none"> <li>1) Perform work of Detachment 1 of ① .</li> <li>2) Turn the coil clockwise (counterclockwise) and then remove it from PMV main unit. (All 4 pcs.)</li> </ol> <p><b>2. Attachment</b></p> <ol style="list-style-type: none"> <li>1) Mount the PMV coil so that the coil lead wire taking-out part directs downward.</li> </ol> <p style="text-align: center;"><b>CAUTION</b></p> <hr/> <p>Coil: Mount yellow coil only so that lead wire taking-out part directs upward.</p> <hr/> <ol style="list-style-type: none"> <li>2) Match the positioning projection of coil with the concave part of PMV unit surely and fix it.</li> </ol> <p><b>Detail B</b></p> 	

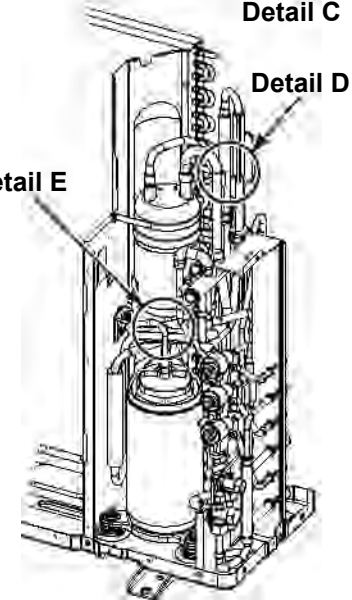

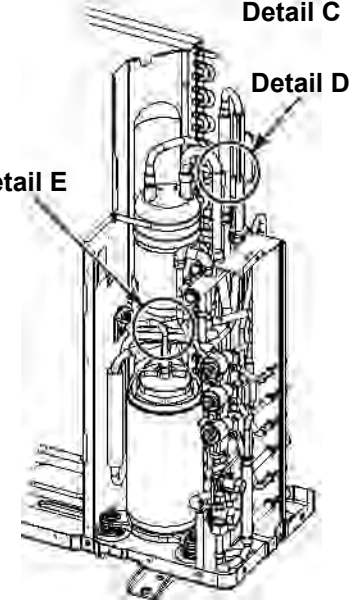
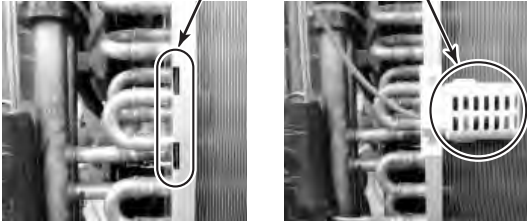

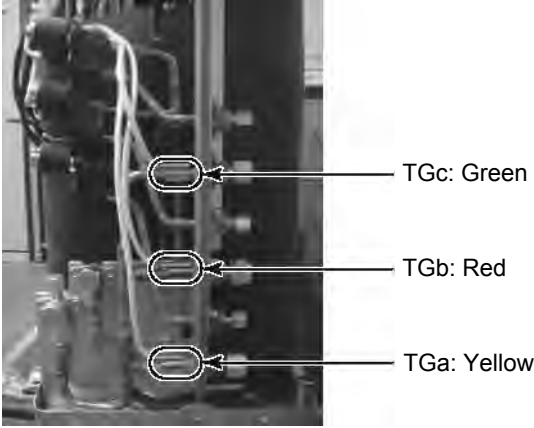
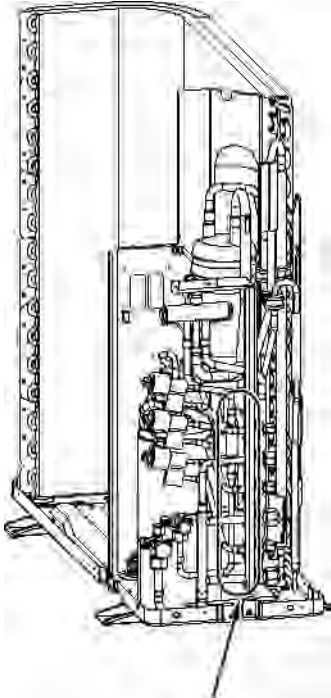
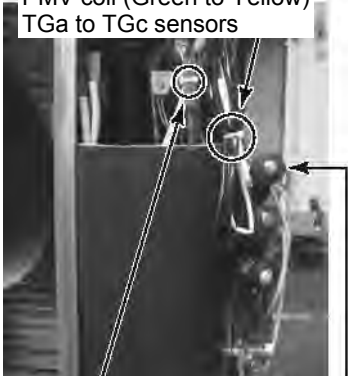
No.	Part name	Procedure	Remarks
⑭	TE sensor (Outdoor heat exchange temperature)	<p>* <b>Attachment</b></p> <p>Mount TE sensor on the straight part of the condenser discharge port pipe so that the lead wire directs upward and the sensor directs the liquid store tank.</p> <p><b>Detail C</b></p> 	
⑮	TS sensor (Suction temperature)	<p>* <b>Attachment</b></p> <p>Insert TS sensor into the sensor holder welded to the suction pipe and then mount it.</p> <p><b>Detail D</b></p> 	
⑯	TD sensor (Discharge temperature)	<p>* <b>Attachment</b></p> <p>Mount TD sensor on the straight part of the discharge pipe so that the lead wire directs upward and the sensor directs upward of the cabinet.</p> <p><b>Detail E</b></p> 	 <p><b>NOTE</b></p> <hr/> <p>At working time (finish time), be sure not to damage the cover of the sensor lead wire with edge of sheet metal, etc.</p> <p>If the cover of the sensor lead wire is damaged, it is dangerous because an electric shock or fire may be caused.</p> <hr/>
⑰	TO sensor (Outside temperature)	<p>* <b>Attachment</b></p> <p>Insert TO sensor holder claw into the heat exchange terminal block hole and then mount it.</p> <p><b>Detail F</b></p> <p>Heat exchange terminal block hole      TO sensor holder</p> 	<p><b>NOTE</b></p> <hr/> <p>After replacing of parts, check the sensors are mounted at the specified positions.</p> <p>If there are incorrect mounted positions, control of the product does not operate correctly and a trouble may be caused.</p> <hr/>

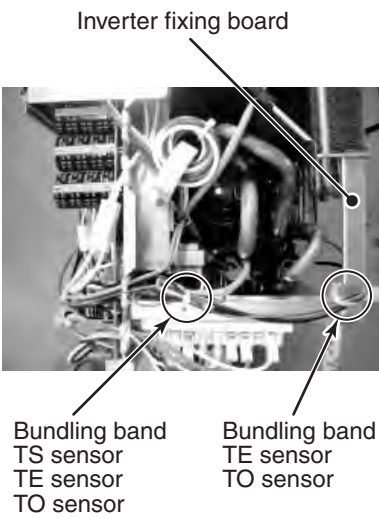
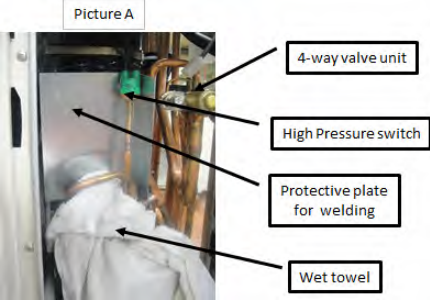
No.	Part name	Procedure	Remarks
⑱	TG sensor TGc: Green TGb: Red TGa: Yellow	<p><b>* Attachment</b></p> <p>Mount these sensors on the directly arranged part of the header connecting pipe at gas side so that the cabinet turns toward the front side and the sensors turn toward upper cabinet.</p> <p><b>NOTE)</b></p> <hr/> <p>When mounting the sensors, check paint color of the sensor lead tube part and the pipe color. Mount the sensors to the position of same color.</p> <hr/> <p><b>Detail G</b></p> 	 <p><b>NOTE)</b></p> <hr/> <p>At working time (finish time), be sure not to damage the cover of the sensor lead wire with edge of sheet metal, etc.</p> <p>If the cover of the sensor lead wire is damaged, it is dangerous because an electric shock or fire may be caused.</p> <hr/> <p><b>NOTE)</b></p> <hr/> <p>After replacing of parts, check the sensors are mounted at the specified positions.</p> <p>If there are incorrect mounted positions, control of the product does not operate correctly and a trouble may be caused.</p> <hr/>
⑲	Sensor wiring process	<ul style="list-style-type: none"> <li>Using bundling band, bind PMV coil (Green to Yellow) with Tga to Tgc.</li> <li>For Td sensor, bind the case thermo and reactor lead by bundling band.</li> </ul> <p>Bundling band                      PMV coil (Green to Yellow)                      TGa to TGc sensors</p>  <p>Pass TG sensor through the upper side of connecting pipe of PMV unit (Green) and then bind it with lead wire of PMV coil.</p> <p>Bundling band                      Td sensor                      Case thermo                      Reactor lead</p> <p><b>NOTE)</b></p> <hr/> <p>Using the bundling band being on the market, be sure to bind the position which was bound.</p> <hr/>	<p><b>NOTE)</b></p> <hr/> <p>At working time (finish time), be sure not to damage the cover of the sensor lead wire with edge of sheet metal, etc.</p> <p>If the cover of the sensor lead wire is damaged, it is dangerous because an electric shock or fire may be caused.</p> <hr/> <p><b>NOTE)</b></p> <hr/> <p>After replacing of parts, check the sensors are mounted at the specified positions.</p> <p>If there are incorrect mounted positions, control of the product does not operate correctly and a trouble may be caused.</p> <hr/>

No.	Part name	Procedure	Remarks
①9	Sensor wiring process (Continued)	<ul style="list-style-type: none"> <li>* Bind TS sensor, TE sensor and TO sensor with the bundling band.</li> <li>* Pass TE sensor and TO sensor through upper part of the inverter fixing board and then bind them with the bundling band.</li> </ul> <p><b>NOTE)</b></p> <hr/> <p>Using the bundling band being on the market, be sure to bind the position which was bound.</p> <hr/>	
②0	Pressure switch	<ol style="list-style-type: none"> <li>1. Detachment                         <ol style="list-style-type: none"> <li>1) Perform work of Detachment 1 of 1.</li> <li>2) Recover the refrigerant gas from the outdoor unit.</li> <li>3) Perform works of 2, 3 and 4.</li> <li>4) Remove the soundproof plate, TD sensor, Reactor on the partition plate and butyl on the pipe of pressure switch.</li> <li>5) Using a burner, remove the welded parts of the pipe of pressure switch.</li> </ol> </li> </ol> <p><b>NOTE)</b></p> <hr/> <p>Take care that the electric parts, 4-way valve unit, butyle, compressor, accum tank, and etc. are not caught by flame.                      (Otherwise operation trouble may occur.)</p> <hr/> <ol style="list-style-type: none"> <li>2. Attachment                         <ul style="list-style-type: none"> <li>• Be sure not to burn lead wire of the pressure switch.</li> <li>• Take care there is no missing of sensor.</li> </ul> </li> </ol> <p><b>NOTE)</b></p> <hr/> <p>Take care that the body of the pressure is not be 100°C or more.                      For cooling pressure switch, use the wet towel and etc.                      Use the protective plate for the welding.</p> <hr/>	

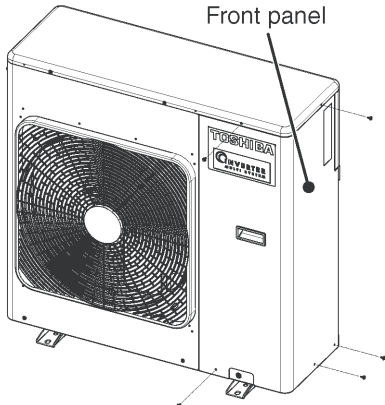
\* RAS-4M27S3AV-A only

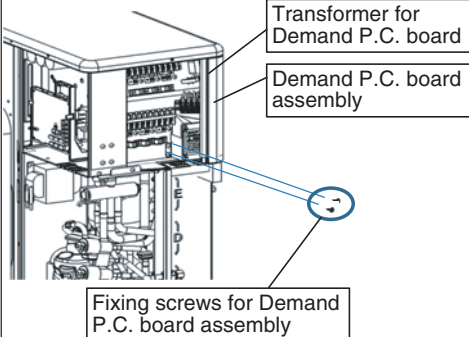
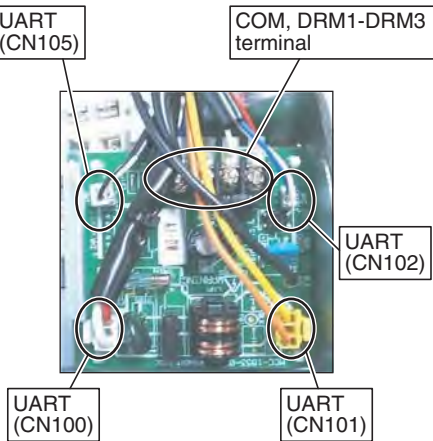
No.	Part name	Procedure	Remarks
②	Demand P.C. board	<p><b>⚠ CAUTION</b></p> <p>Never forget to put on the gloves at working time; otherwise an injury will be caused by the parts etc.</p> <hr/> <p><b>NOTE)</b></p> <p>When working, be sure to use the insulate tools and put on the insulated gloves.</p> <hr/> <p><b>⚠ WARNING</b></p> <p>Never disassemble the inverter until 5 minutes after the power supply was turned off because there is a fear that an electric shock may occur.</p> <hr/> <p><b>1. Detachment</b></p> <ol style="list-style-type: none"> <li>1) Stop operation of the air conditioner, and turn off the switch of the breaker.</li> <li>2) Remove the front panel. (Hexagonal screw Ø4 × 10, 5 pcs.) <ul style="list-style-type: none"> <li>• After taking off screws, the front panel is pulled downward ①.</li> <li>The front panel is pulled forward and removed ②.</li> </ul> </li> <li>3) Remove the power supply cable and the indoor/outdoor/DRED connecting wire from the cord clamp and the terminal.</li> <li>4) Remove the fixing screws of Demand P.C. board assembly, and draw out the Demand P.C. board. (Truss head B tight Ø4 × 6, 2pcs.)</li> <li>5) Remove the earth screws. (Truss head B tight Ø4 × 6, 1pc.)</li> <li>6) Remove the power supply wiring and relay connector connected to the Demand P.C. board.            CN100 : UART (2P, White)            CN101 : UART (2P, Yellow)            CN102 : UART (2P, White)            CN105 : UART (2P, White)            COM terminal: Red lead wire            DRM1 terminal: White lead wire            DRM2 terminal: Black lead wire            DRM3 terminal: Blue lead wire            * Unlock the lock of the housing unit and then remove the connectors.         </li> <li>7) Remove the Demand P.C. board from the fixture.</li> <li>8) Exchange the Demand P.C. board with a new one.</li> </ol> <hr/> <p><b>NOTE)</b></p> <p>Using the bundling band being on the market, be sure to bind the position which was bound.</p> <hr/>	 <p>Front panel</p>  <p>Front panel</p> <p>① Downward</p> <p>② Forward</p>  <p>Transformer for Demand P.C. board</p> <p>Demand P.C. board assembly</p> <p>Fixing screws for Demand P.C. board assembly</p>  <p>UART (CN105)</p> <p>COM, DRM1-DRM3 terminal</p> <p>UART (CN102)</p> <p>UART (CN100)</p> <p>UART (CN101)</p>

### 13. EXPLODED VIEWS AND PARTS LIST

#### 13-1. Outdoor Unit

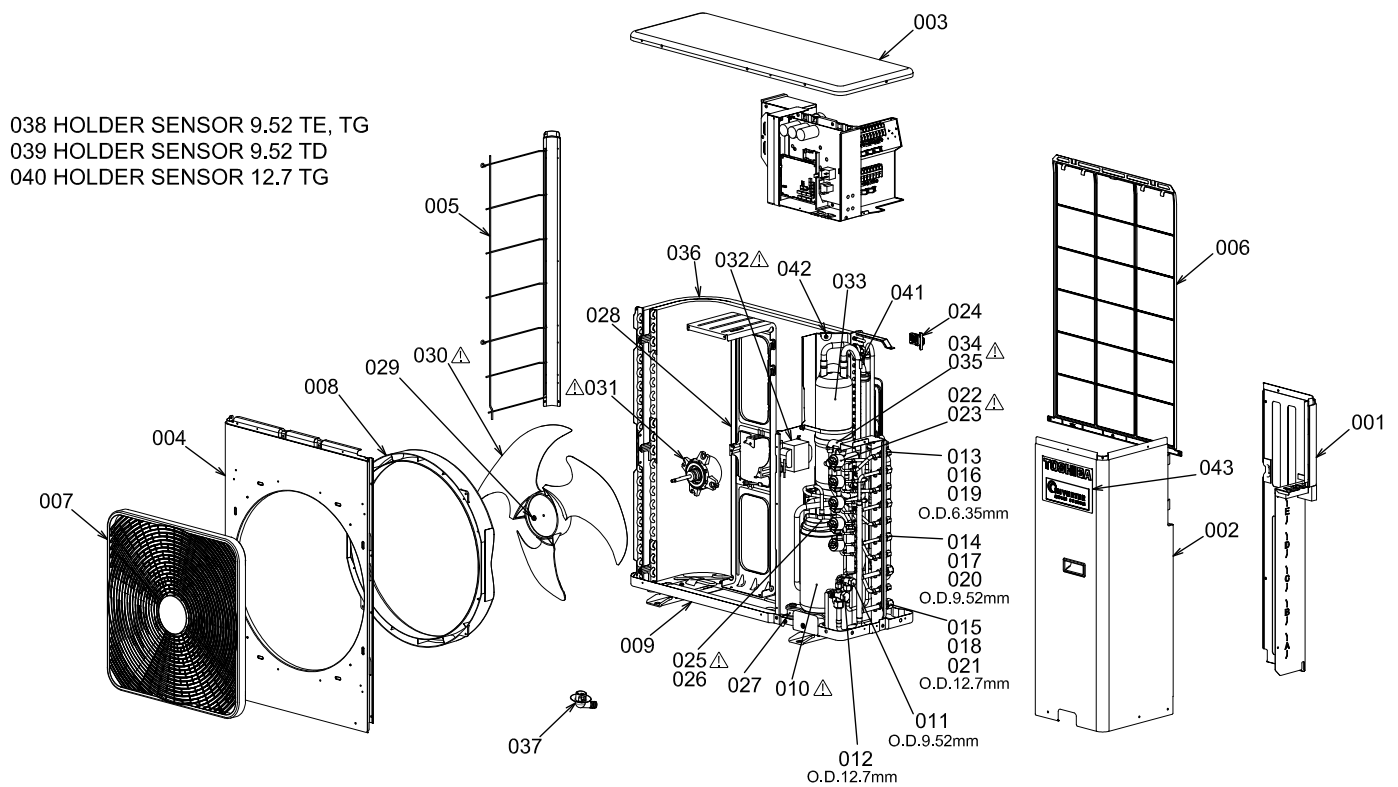

Location No.	Part No.	Description	Location No.	Part No.	Description
1	43T00661	ASM-CABI-BACK	23	43T46440	COIL-PMV
2	43T00659	ASM-PANEL-FRONT	24	43T63335	HOLDER-SENSOR
3	43T00564	UPPER CABINET ASSEMBLY	25	43T54319	BIMETAL-THERMO
4	43T00551	AIR OUTLET CABINET	26	43T50307	BIMETAL THERMOSTAT ASSEMBLY
5	43T19346	FIN GUARD ASSEMBLY	27	43T49346	RUBBER CUSHION
6	43T19345	FIN GUARD	28	43T39342	MOTOR BASE
7	43T19343	FAN GUARD(TOSHIBA)	29	43T47001	NUT FLANGE
8	43T22313	BELLMOUTH	30	43T20329	PROPELLER FAN
9	43T42347	BASE PLATE ASSEMBLY	31	43T21429	FAN MOTOR
10	43T41477	COMPRESSOR	32	43T58307	REACTOR
11	43T46380	VALVE;PACKED 9.52 DIA	33	43T48310	ACCUMULATOR ASSEMBLY
12	43T46427	VALVE;PACKED 12.7 DIA	34	43T46383	VALVE-4WAY
13	43T46443	SOCKET, 6.35 DIA	35	43T63344	COIL-V-4WAY
14	43T46442	SOCKET, 9.52 DIA	36	43T43514	CONDENSER ASSEMBLY
15	43T46441	SOCKET, 12.7 DIA	37	43T79305	DRAIN NIPPLE
16	43AN0278	FLARE-NUT-SERVICE	38	43T63316	HOLDER,SENSOR
17	43AN0106	FLARE-NUT	39	43T63317	HOLDER,SENSOR
18	43049788	NUT-FLARE	40	43T63323	HOLDER,SENSOR
19	43T47399	BONNET, 6.35 DIA	41	43T19333	HOLDER, SENSOR
20	43T47398	BONNET, 9.52 DIA	42	43T96305	BUSHING
21	43T47397	BONNET, 12.7 DIA	43	43T85591	MARK-T
22	43T46439	BODY-PMV			



13-2. Inverter Assembly

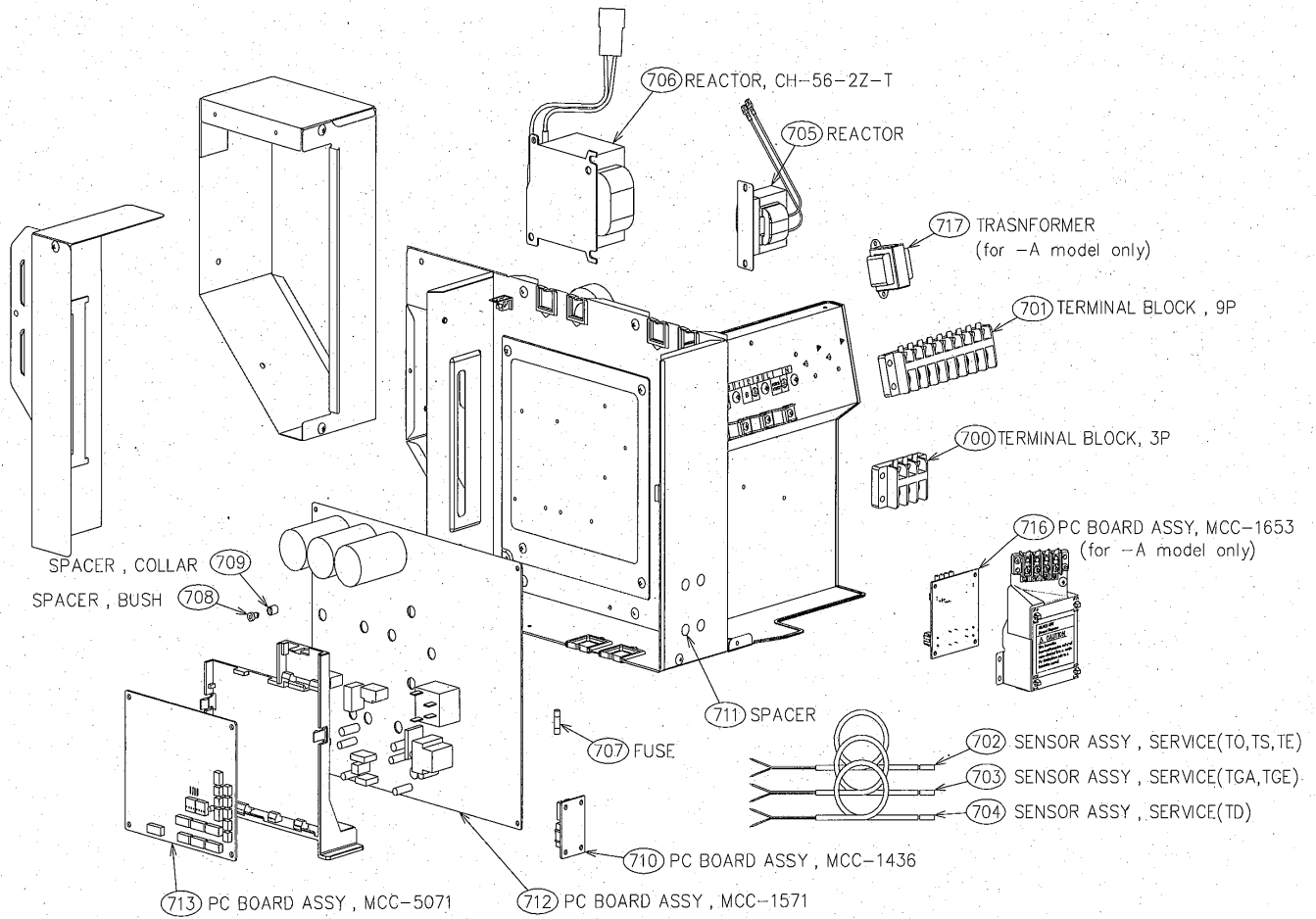

Location No.	Part No.	Description	Location No.	Part No.	Description
700	43T60427	TERMINAL BLOCK,3P,20A	708	43T61315	SPACER(BUSH)
701	43T60452	SERV-TERMINAL	709	43T61316	SPACER(COLLAR)
702	43T50347	SENSOR ASSY, SERVICE	710	43T6V587	ASM-PCB(FAN-REL)
703	43T50356	SERVICE-SENSOR	711	43T61324	ASM-SPACER-SET
704	43T60433	SENSOR ASSY,SERVICE	712	43T6V586	PC-BOARD
705	43T60422	REACTOR	713	43T6V585	PC-BOARD
706	43T58307	REACTOR	716	43T6V475	PC BOARD(DRC)(for RAS-3M26S3AV-A)
707	43T60426	FUSE	717	43T58322	TRANSFORMER(for RAS-3M26S3AV-A)

**TOSHIBA CARRIER (THAILAND) CO., LTD.**